



ctesi

SOLUÇÕES TÉCNICAS

MAR. 2022



25
ANOS
DESDE 1997



DESENHADO E FABRICADO EM PORTUGAL

A tecnologia evoluiu, os materiais mudaram, mas a base do nosso compromisso manteve-se inalterada: A prestação de um serviço de excelência que prima pela qualidade, funcionalidade dos seus produtos e satisfação dos nossos clientes. Tudo, através da marca portuguesa Ctesi.

A Ctesi é uma das maiores referências do sector e pretende deixar uma marca que perdura pelo futuro.

O investimento na investigação para o desenvolvimento e produção de artigos próprios é o ADN da Ctesi.

Desenvolvemos um sistema de produção onde assumimos controlo sobre todo o processo, acrescentando valor qualitativo a cada uma das etapas da cadeia de produção.

Barros & Moreira, SA

Rua Industrial, nº 8
Zon Industrial da Ponte Seca
2510-752 Gaeiras - Óbidos
Portugal

geral@barros-moreira.pt
www.ctesi.pt
Tel.: (+351) 262 837 230 || Fax: (+351) 262 837 231
Serviço de apoio pós venda **LINHA AZUL 808 203 870**



Cofinanciado por:



UNIÃO EUROPEIA
Fundo Europeu
de Desenvolvimento Regional

A **Ctesi Technic** é a vertente dos produtos técnicos da **Ctesi**. Estamos vocacionados para a produção e comercialização de todos os tipos de artigos plásticos sanitários, com maior destaque para os autoclismos, válvulas de descarga, torneiras de boia, tampos de sanita, calhas de duche, entre outros. Estes produtos passam por rigorosos testes de qualidade, de modo a garantir um excelente funcionamento, eficiência e durabilidade do material.

Focamo-nos nas necessidades dos técnicos de instalação, mas também na satisfação dos consumidores finais, garantindo produtos de instalação simples e de desempenho eficaz.

Neste variado portefólio de produtos encontramos os autoclismos interiores de simples instalação e fácil acesso e que assumem, de forma natural, um maior protagonismo pela sua combinação de tecnologia eficiente e adaptabilidade.

Encontramos ainda as válvulas de descarga que permitem uma poupança, de até 50%, de água, as torneiras de boia silenciosas e de rápido enchimento, as calhas de duche adaptáveis e que proporcionam uma perfeita drenagem de água.

Todos estes produtos são desenvolvidos com os melhores plásticos disponíveis no mercado, sendo escolhidos pela sua elevada qualidade, garantindo uma maior durabilidade e vida útil de cada produto.

Primamos pela produção e comercialização de artigos com elevados padrões de qualidade, que permitam a poupança do mais importante recurso - a água -, criando assim sistemas de verdadeira eficiência hídrica.

Todos os nossos produtos estão conforme as normas e padrões de exigência de qualidade do espaço económico europeu.



1 ARTIGOS PLÁSTICOS SANITÁRIOS

	autoclismos interiores	6		tela impermeabilizante isol	32
	estruturas metálicas	12		kits calhas de duche	34
	placas de comando	13		calhas de duche	36
	autoclismos exteriores	14		válvulas de duche	40
	torneiras de boia	19		sifões de pavimento	42
	válvulas de descarga	21		tampas para sifão	46
	acessórios autoclismo	24		ventiladores	47
	tubos extensíveis	26		duchetas higiénicas	48
	excêntricos sanita	30		sifões lava-louça	50
	tubos sanita	31		acessórios lava-louça	52
				sifões máquina de lavar	53

2 TAMPOS DE SANITA

	polipropileno	56		torneiras de esquadria	84
	duroplast	57		válvulas de esfera	86
	duroplast soft close	58		torneiras de serviço	86
	mdf	61		bichas malha de aço	87
	contraplacado marítimo	66		válvulas de lavatório	90
	acessórios tampos de sanita	71		sifões de lavatório	91

3 SISTEMAS E ACESSÓRIOS

	tubo pex / al / pe	74		perlatores	94
	acessórios roscar	76		acessórios torneiras	96
	acessórios cravar	79		acessórios cromados	101
			CONDIÇÕES GERAIS		104



EFICIÊNCIA
HÍDRICA



DESCARGA
DUPLA



SISTEMA
START/STOP



ENCAIXE
COM ROSCA



ENCAIXE
RÁPIDO



ANTI
CONDENSAÇÃO



SILENCIOSO



FÁCIL INSTALAÇÃO
E MANUTENÇÃO



PROFUNDIDADE



CASQUILHO
PLÁSTICO



CASQUILHO
LATÃO



ANTI-TORÇÃO



CONFORME CE



UNIVERSAL



SOFT-CLOSE



CAIXA



SACO
PLÁSTICO



TAMANHOS
PERSONALIZADOS

1 artigos plásticos sanitários

Ctesi apresenta um conjunto de soluções e novos produtos que assentam num forte compromisso entre a fiabilidade, a eficiência hídrica e o design, de modo a construir uma oferta apelativa que apresentamos nas páginas seguintes.

A gama de autoclismos Ctesi destaca-se pela qualidade dos materiais e durabilidade. Equipamos os nossos produtos com torneiras de boia silenciosas de rápido enchimento e válvulas de descarga desenvolvidas para lhe proporcionar a máxima eficiência hídrica.

Contribuímos para que pequenos gestos façam toda a diferença, poupando no consumo de água sem afetar a eficiência e o conforto no uso deste recurso essencial à vida.



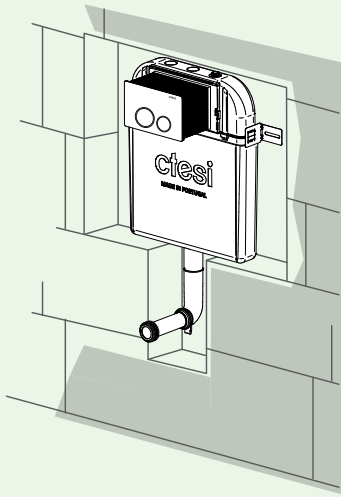

SIMPLE

É a solução ideal para instalação em paredes resistentes, para fixação de instalações sanitárias ao chão. Construído com materiais de alta qualidade, as cisternas ocultas simples são robustas e permitem uma economia considerável de espaço.

Equipados com sistema de descarga dupla e torneiras silenciosas, permitem um enchimento rápido e garantem uma rápida instalação, assim como um fácil acesso ao interior através da placa de controle.

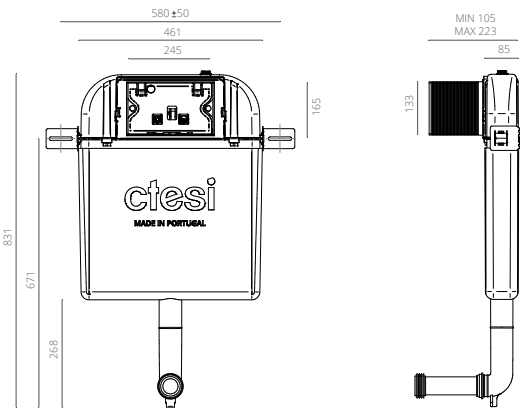

CARACTERÍSTICAS

- Sem estrutura
- Dupla descarga 3/6l; regulável 3/4,5l
- Isolamento anticondensação e acústico em esferovite com alvéolos
- Torneira de boia silenciosa
- Profundidade 80 mm
- Reservatório em polipropileno (PP) altamente resistente (Temp. água max. 25°C)
- Instalação em paredes de alvenaria
- Marcação CE: EN 14055
- Eficiência energética: classe A
- Compatível com todas as sanitas de fixação ao chão

INCLUI

- Tubo de descarga
- Tubo de ligação à sanita
- Kit de fixação para alvenaria
- Rede para aplicação em paredes de alvenaria
- Torneira de esquadria G1/2"



SIMPLE

REF.	DESIGNAÇÃO			€
BK0200200	SIMPLES	1	-	119,40

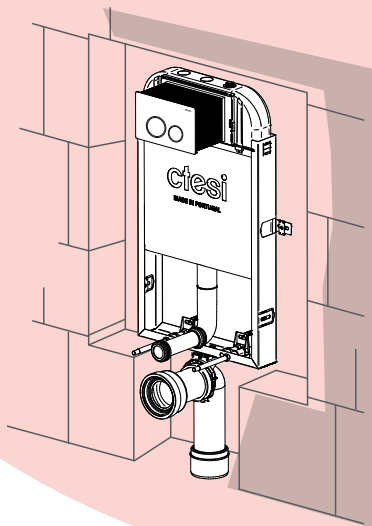

EASY

Autoclismo interior da gama de soluções Ctesi®, ideal para a instalação de louças sanitárias em paredes resistentes, tais como paredes de tijolo. Os autoclismos EASY são projetados para aplicação em paredes de alvenaria.

Esta gama de autoclismos permite maior liberdade para criar o seu espaço de banho com mais espaço livre, com forte compromisso entre a confiabilidade, eficiência hídrica e design.

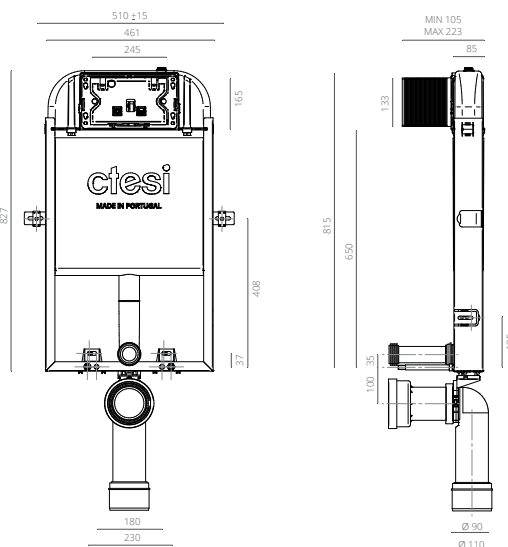
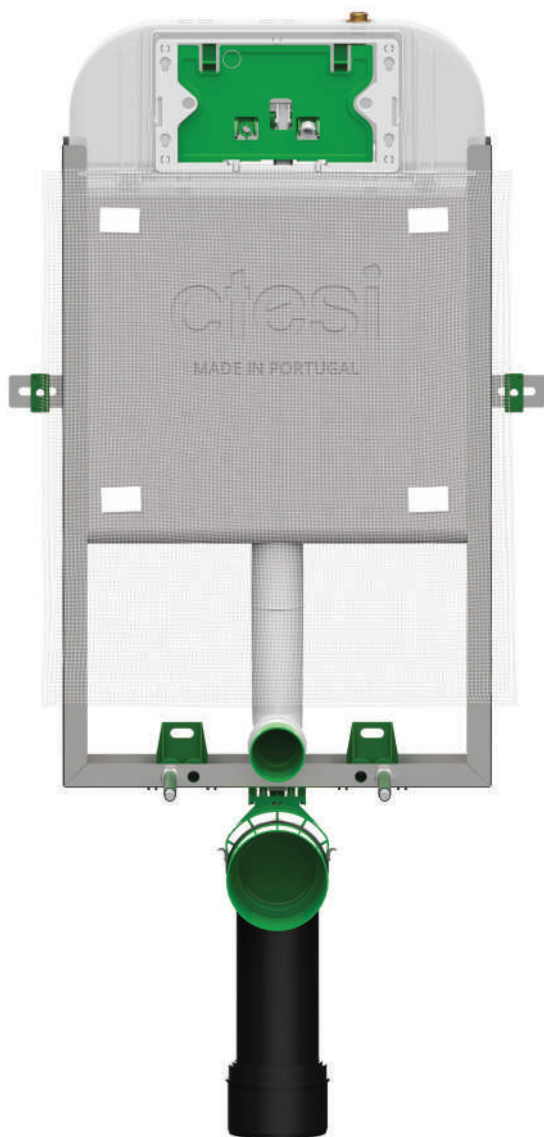

CARACTERÍSTICAS

- Com estrutura para paredes de alvenaria
- Dupla descarga 3/6l; regulável 3/4,5l
- Isolamento anticondensação e acústico em esferovite com alvéolos
- Torneira de boia silenciosa
- Profundidade 80 mm
- Reservatório em polipropileno (PP) altamente resistente (Temp. água max. 25°C)
- Marcação CE: EN14055
- Eficiência energética: classe A
- Curva de esgoto ajustável em profundidade

INCLUI

- Tubo de descarga
- Tubo de ligação à sanita
- Kit de fixação de estrutura
- Kit de fixação para louça sanitária
- Rede para aplicação em paredes de alvenaria
- Torneira de esquadria G1/2"
- Curva de esgoto D90/90
- Adaptador D90/110



EASY

REF.	DESIGNAÇÃO			€
BK0200220	COM ESTRUTURA	1	-	149.20

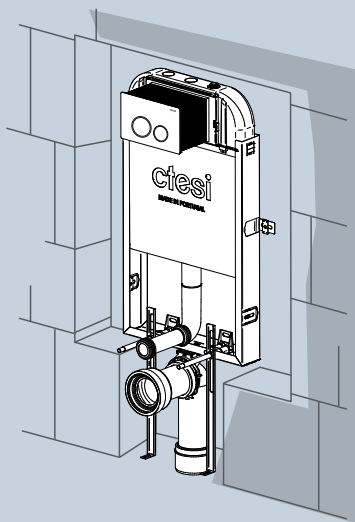

EASY COM PÉS

Autoclismo interior da gama de soluções Ctesi®, ideal para a instalação de louças sanitárias em paredes resistentes, tais como paredes de tijolo. Os autoclismos EASY são projetados para aplicação em paredes de alvenaria.

Os pés em aço galvanizado permitem auxiliar a montagem da estrutura EASY para aplicação de louça suspenso. Os pés Easy permitem ajustar a altura de fixação da estrutura Easy com autoclismo interior, conferindo uma maior resistência à estrutura enquanto contribuem para uma instalação mais fácil e nivelamento do autoclismo interior com estrutura Easy.

Estruturas galvanizadas para encastrar em paredes de alvenaria, para instalação de louças sanitárias suspensas. Posição da curva de esgoto regulável em profundidade.

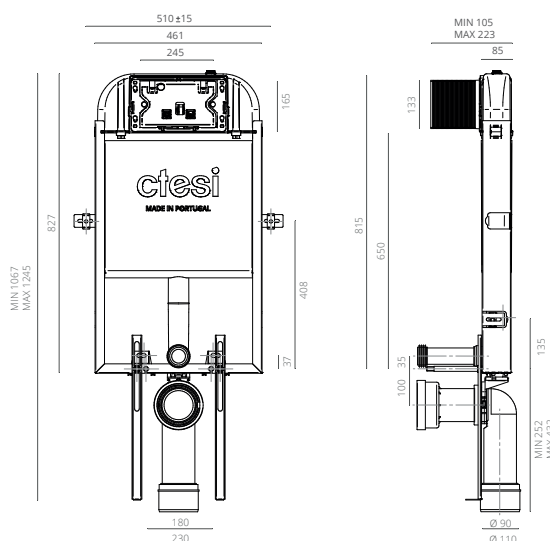

CARACTERÍSTICAS

- Com estrutura para paredes de alvenaria
- Com pés ajustáveis
- Dupla descarga 3/6l; regulável 3/4,5l
- Isolamento anticondensação e acústico em esferovite com alvéolos
- Torneira de boia silenciosa
- Profundidade 80 mm
- Reservatório em polipropileno (PP) altamente resistente (Temp. água máx. 25°C)
- Marcação CE: EN 14055
- Eficiência energética: classe A
- Curva de esgoto ajustável em profundidade

INCLUI

- Tubo de descarga
- Tubo de ligação à sanita
- Kit de fixação da estrutura
- Kit Fixação para louça sanitária
- Rede para aplicação em paredes de alvenaria
- Torneira de esquadria G1/2"
- Curva de esgoto D90/90
- Adaptador D90/110



EASY COM PÉS

REF.	DESIGNAÇÃO			€
BK0200221	COM ESTRUTURA E PÉS	1	-	171.60

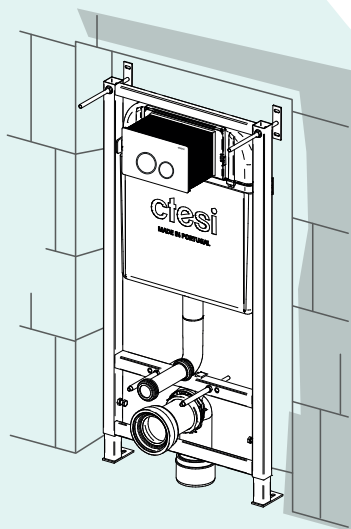

SOLID

Solid é um sistema de instalação com alta resistência mecânica para a instalação de louças sanitárias em paredes de gesso, ideal para novas construções ou remodelações.

Estrutura metálica de fixação à parede e ao chão, regulável em altura para instalação de louças sanitárias suspensas. Aplicação em paredes de alvenaria, paredes ligeiras ou calha técnica. Posição da curva de esgoto regulável em profundidade.

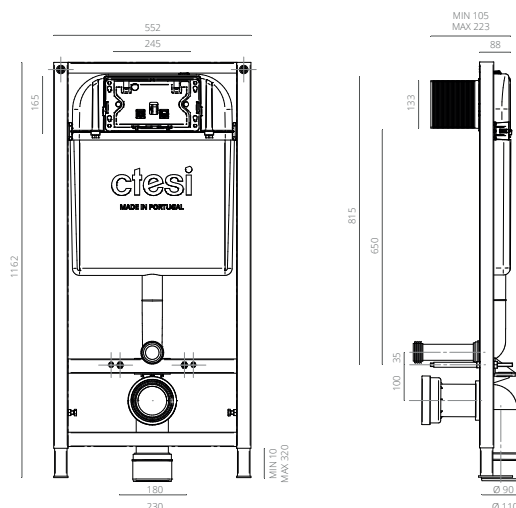

CARACTERÍSTICAS

- Com estrutura para paredes de alvenaria, paredes ligeiras ou calha técnica
- Dupla descarga 3/6l; regulável 3/4,5l
- Isolamento anticondensação e acústico em esferovite com alvéolos
- Torneira de boia silenciosa
- Profundidade 80 mm
- Suporta até 400 Kg
- Reservatório em polipropileno (PP) altamente resistente (Temp. água máx. 25°C)
- Marcação CE: EN 14055
- Eficiência energética: classe A
- Curva de esgoto ajustável em profundidade
- Altura regulável de 0-300 mm

INCLUI

- Tubo de descarga
- Tubo de ligação à sanita
- Kit de fixação da estrutura
- Kit Fixação para louça sanitária
- Torneira de esquadria C1/2"
- Curva de esgoto D90/90
- Adaptador D90/110



SOLID

REF.	DESIGNAÇÃO		€
BK0200240	COM ESTRUTURA	1	238.70

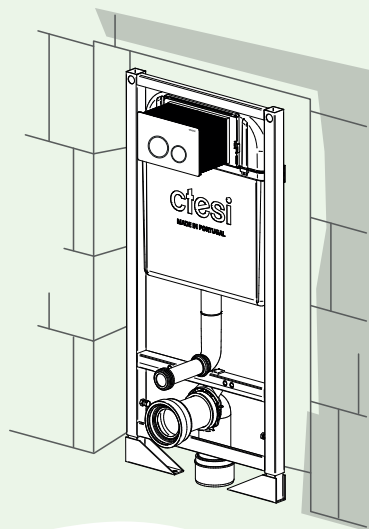

SELF SIMPLES

O SELF SIMPLES foi concebido para simplificar - para instaladores e consumidores finais - todo o processo de instalação e utilização. Simples no processo, eficiente na tecnologia. É o sistema ideal para a instalação de louça sanitária suspensa em paredes ligeiras, permitindo uma real economia de espaço.

O design inteligente, adaptado e seguro, garante uma instalação rápida através da sua estrutura com sistema de fixação ao chão. O isolamento anti condensação evita a acumulação de águas e o isolamento acústico garante-lhe um sistema silencioso.

É um sistema adaptável que lhe permite regular, a altura entre os 0-300mm, o sistema de dupla descarga ou mesmo a posição da curva de esgoto.

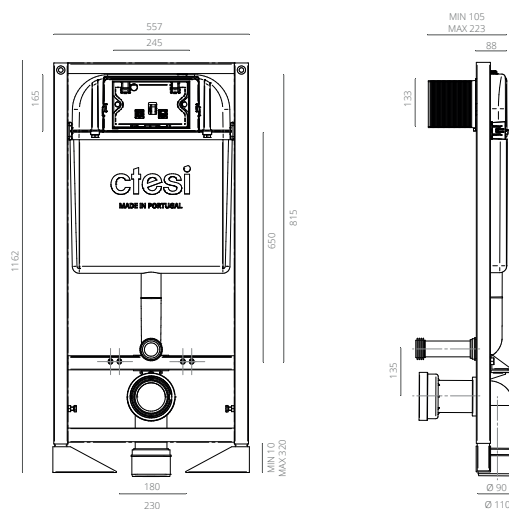

CARACTERÍSTICAS

- Com estrutura para fixação ao chão em paredes ligeiras
- Dupla descarga 3/6l; regulável 3/4,5l
- Isolamento anticondensação e acústico em esferovite com alvéolos
- Torneira de boia silenciosa
- Profundidade 80 mm
- Suporta até 400kg
- Reservatório em polipropileno (PP) altamente resistente (Temp. água máx. 25°C)
- Marcação CE: EN 14055
- Eficiência energética: classe A
- Curva de esgoto ajustável em profundidade
- Altura regulável de 0-300 mm

INCLUI

- Tubo de descarga
- Tubo de ligação à sanita
- Kit de fixação da estrutura
- Kit Fixação para louça sanitária
- Torneira de esquadria G1/2"
- Curva de esgoto D90/90
- Adaptador D90/110



SELF SIMPLES

REF.	DESIGNAÇÃO			€
BK0200260	COM ESTRUTURA	1	-	322,20

SELF DUPLO

Um único sistema para duas sanitas diferentes. SELF DUPLO é a escolha acertada na instalação de louças sanitárias suspensas “costas com costas” na mesma parede. Indicado para paredes ligeiras, combina a mais recente tecnologia sanitária com a eficiência de uso e simplicidade de instalação.

Permite uma instalação rápida devido ao seu design inteligente, funcional e seguro através da sua estrutura com sistema de fixação ao chão. O isolamento anti condensação evita a acumulação de águas, e o isolamento acústico, e garante-lhe um real sistema silencioso.

Permite-lhe regular a altura entre os 0-300mm, o sistema de dupla descarga ou mesmo a posição da curva de esgoto.

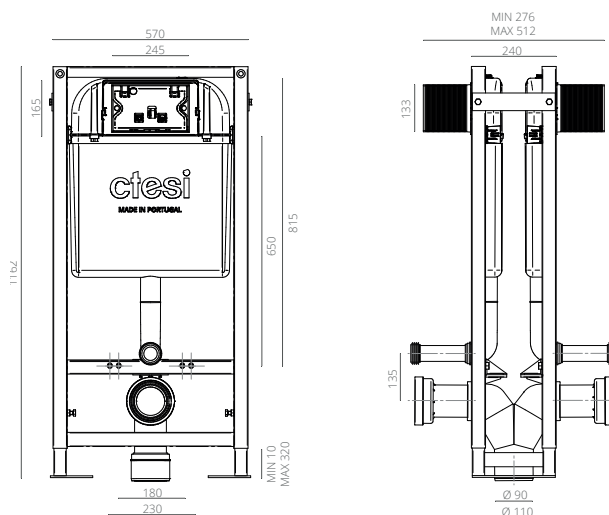

CARACTERÍSTICAS

- Com estrutura para fixação ao chão em paredes ligeiras
- Estrutura metálica para aplicação de 2 sanitas suspensas “costas com costas”
- Dupla descarga 3/6l; regulável 3/4,5l
- Isolamento anticondensação e acústico em esferovite com alvéolos
- Torneira de boia silenciosa
- Profundidade 80 mm
- Suporta 400 kg
- Reservatório em polipropileno (PP) altamente resistente (Temp. água máx. 25°C)
- Marcação CE: EN 14055
- Eficiência energética: classe A
- Curva de esgoto ajustável em profundidade
- Altura regulável de 0-300 mm

INCLUI

- Tubo de descarga
- Tubo de ligação à sanita
- Kit de fixação da estrutura
- Kit Fixação para louça sanitária
- Torneira de esquadria C1/2”
- Curva de esgoto em “Y” D90
- Adaptador D90/110



SELF DUPLO

REF.	DESIGNAÇÃO			€
BK0200261	COM ESTRUTURA E PÉS	1	-	507.30

SOLUÇÕES DE ENCASTRAR

Com a gama de soluções para estruturas sanitárias embutidas Ctesi® tem toda a liberdade para criar o seu espaço de banho com mais espaço livre, num forte compromisso entre a fiabilidade, a eficiência hídrica e o design.

Toda a gama foi desenvolvida para oferecer a melhor prestação em utilizações intensivas, quer seja para espaços públicos ou privados.



- Estrutura metálica para lavatório suspenso
- Fixação à parede ou ao chão (em paredes ligeiras)
- Fácil instalação e manutenção
- Altura ajustável
- Suporta até 150 kg

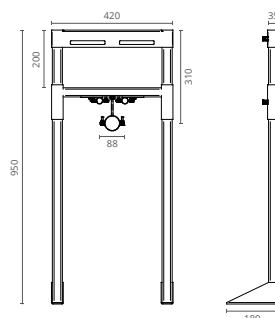

SOLID

REF.	DESIGNAÇÃO			€
BK0204020	ESTRUTURA LAVATÓRIO	1	-	180.40



- Estrutura metálica para urinol
- Fixação à parede e ao chão
- Fácil instalação e manutenção
- Altura ajustável
- Suporta até 150 kg

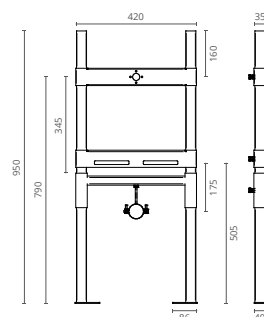

SOLID

REF.	DESIGNAÇÃO			€
BK0204030	ESTRUTURA URINOL	1	-	223.70



- Estrutura metálica para bidé
- Fixação à parede e ao chão
- Fácil instalação e manutenção
- Altura ajustável
- Suporta até 400 kg

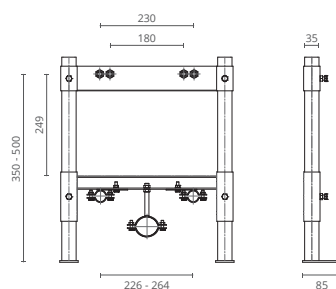

SOLID

REF.	DESIGNAÇÃO			€
BK0204010	ESTRUTURA BIDÉ	1	-	112.90



- Estrutura metálica para bidé
- Fácil instalação e manutenção
- Altura ajustável
- Suporta até 400 kg

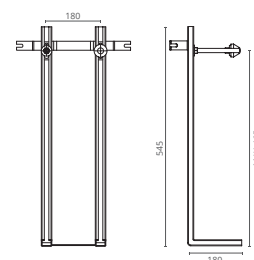

EASY

REF.	DESIGNAÇÃO			€
BK0204100	ESTRUTURA BIDÉ	1	-	43.10

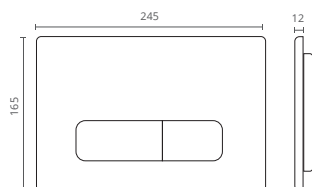
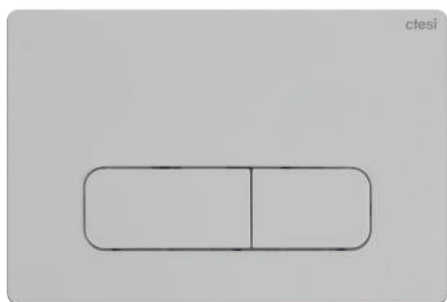

CROMADO MATE BRANCO PRETO GRAFITE OURO BRONZE



KEEN

REF.	COR / ACABAMENTO			€
BK0202100	CROMADO	1	-	42.10
BK0202103	MATE	1	-	42.10
BK0202101	BRANCO	1	-	28.20
BK0202102	PRETO	1	-	44.80
BK0202107	GRAFITE	1	-	99.40
BK0202108	OURO	1	-	99.40
BK0202109	BRONZE	1	-	99.40

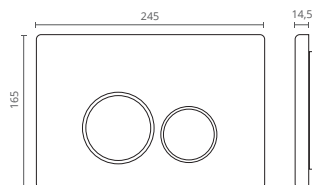

CROMADO MATE BRANCO PRETO GRAFITE OURO BRONZE



ROUND

REF.	COR / ACABAMENTO			€
BK0202120	CROMADO	1	-	42.10
BK0202123	MATE	1	-	42.10
BK0202121	BRANCO	1	-	28.20
BK0202122	PRETO	1	-	44.80
BK0202127	GRAFITE	1	-	99.40
BK0202128	OURO	1	-	99.40
BK0202129	BRONZE	1	-	99.40

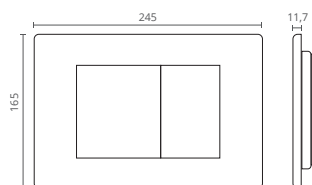
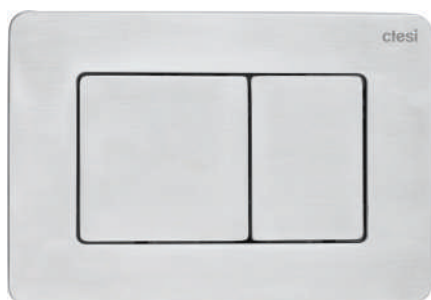

STEEL

REF.	COR / ACABAMENTO			€
BK0202140	AÇO INOX - ESCOVADO	1	-	130.60

TIPOS DE APLICAÇÃO

A Monobloco

Para aplicação acoplada directamente sobre a sanita. Ideal para a substituição de autoclismos cerâmicos.

(Pag. 12)

B Mochila

Para aplicação com fixação na parede, fornecido com tubo de descarga para ligação e limpeza da sanita.

(Pag. de 13 a 16)

C Alto

Para aplicação com fixação em posição alta na parede, fornecido com tubo de descarga até 1,60m de altura e puxador para accionamento da descarga para a limpeza de sanitas ou sanitas turcas.

(Pag. 16)



ONDABLOC

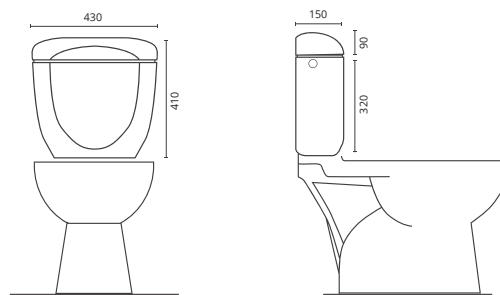

- Descarga dupla (3/6 litros)
- Fácil regulação do volume de descarga máxima até 9 litros
- Sistema de montagem para instalação acoplada à sanita
- Entrada de água lateral (esquerda/direita) ou inferior e posterior
- Isolamento anti-condensação e acústico
- Fácil instalação e manutenção
- Inclui todos os acessórios necessários para instalação
- Válvula de descarga com vedante em silicone
- Fornecido em embalagem individual
- Em conformidade com a norma europeia (EN14055)



REF.	COR - MODELO			€
BK0010500	BRANCO - ENTRADA LATERAL 3/8"	1	4	69,70
BK0010501	BRANCO - ENTRADA INFERIOR 3/8"	1	4	69,70

BAHIA DUO

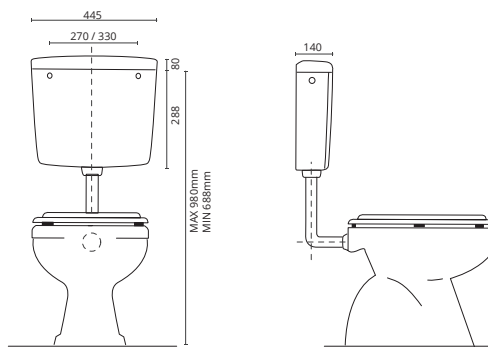

- Descarga dupla (3/6 litros)
- Fácil regulação do volume de descarga máxima até 9 litros
- Entrada de água lateral (esquerda/direita) e posterior
- Isolamento anti-condensação e acústico
- Fácil instalação e manutenção
- Inclui todos os acessórios necessários para instalação
- Válvula de descarga com vedante em silicone
- Com tubo de descarga Ø50 x Ø40 x 325 mm
- Fornecido em embalagem individual
- Em conformidade com a norma europeia (EN14055)



REF.	COR - MODELO			€
BK0010100	BRANCO - 3/8"	1	5	45,90

BAHIA

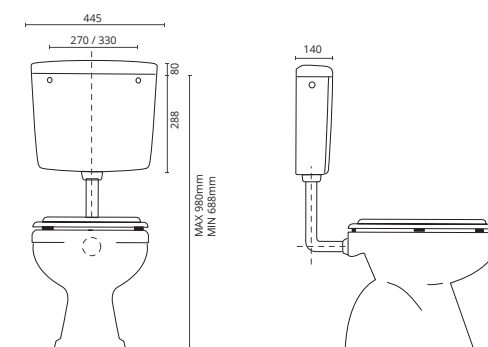

- Descarga interrompível (até 6 litros)
- Fácil regulação do volume de descarga máxima entre 6l e 9l
- Entrada de água lateral (esquerda/direita) e posterior
- Isolamento anti-condensação e acústico
- Fácil instalação e manutenção
- Inclui todos os acessórios necessários para instalação
- Válvula de descarga com vedante em silicone
- Com tubo de descarga Ø50 x Ø40 x 325 mm
- Fornecido em embalagem individual
- Em conformidade com a norma europeia (EN14055)



REF.	COR - MODELO			€
BK0000400	BRANCO - 3/8"	1	5	41,90

IARA DUO

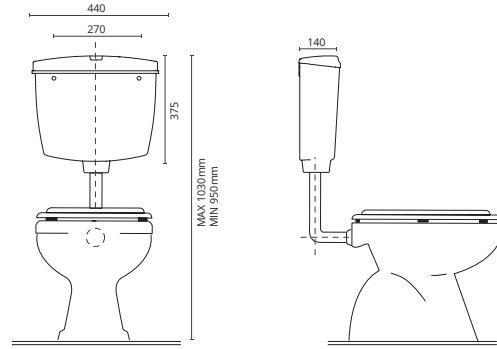

- Descarga dupla (3/6 litros)
- Fácil regulação do volume de descarga máxima até 9l
- Sistema de encaixe rápido do tubo de descarga
- Entrada de água lateral (esquerda/direita) e posterior
- Isolamento anti-condensação e acústico
- Fácil instalação e manutenção
- Inclui todos os acessórios necessários para instalação
- Válvula de descarga com vedante em silicone
- Com tubo de descarga Ø50 x Ø40 x 325 mm
- Fornecido em embalagem individual
- Em conformidade com a norma europeia (EN14055)



REF.	COR - MODELO	CORES DISPONÍVEIS			€
BK0010000	BRANCO - 3/8"		1	5	43,40
BK0010001	CINZENTO - 3/8"		1	5	45,90
BK0010002	PERGAMÓN - 3/8"		1	5	45,90
BK0010003	ROSA - 3/8"		1	5	45,90

IARA

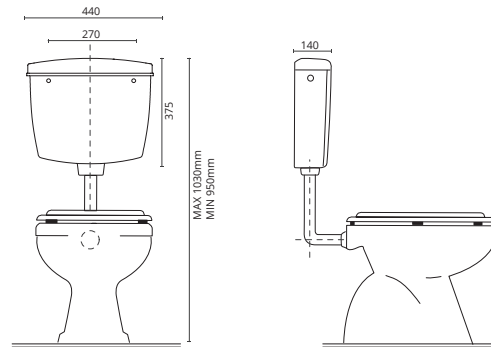

- Descarga interrompível (até 6 litros)
- Fácil regulação do volume de descarga máxima entre 6l e 9l
- Sistema de encaixe rápido do tubo de descarga
- Entrada de água lateral (esquerda/direita) e posterior
- Isolamento anti-condensação e acústico
- Fácil instalação e manutenção
- Inclui todos os acessórios necessários para instalação
- Válvula de descarga com vedante em silicone
- Com tubo de descarga Ø50 x Ø40 x 325 mm
- Fornecido em embalagem individual
- Em conformidade com a norma europeia (EN14055)



REF.	COR - MODELO			€
BK0000300	BRANCO - 3/8"	1	5	40,90

SAMPI

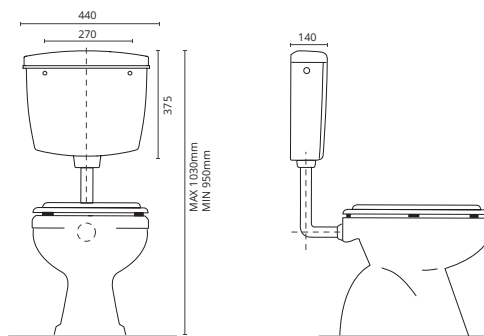

- Descarga interrompível (até 6 litros)
- Fácil regulação do volume de descarga máxima entre 6l e 9l
- Montagem rápida
- Entrada de água lateral (esquerda/direita) e posterior
- Isolamento anti-condensação e acústico
- Fácil instalação e manutenção
- Inclui todos os acessórios necessários para instalação
- Válvula de descarga com vedante em silicone
- Com tubo descarga Ø50 x Ø40 x 325 mm
- Fornecido em embalagem individual
- Em conformidade com a norma europeia (EN14055)



REF.	COR - MODELO			€
BK0000200	BRANCO - 3/8"	1	5	40.60

IOCA

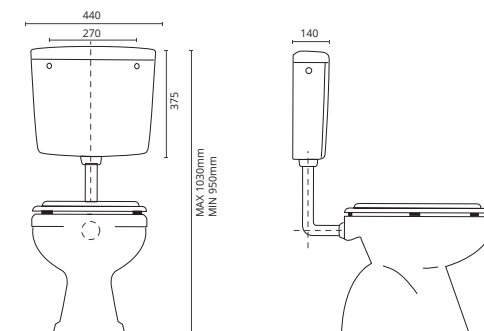

- Descarga interrompível (até 6 litros)
- Fácil regulação do volume de descarga máxima entre 6l e 9l
- Sistema de encaixe rápido do tubo de descarga
- Entrada de água lateral (esquerda/direita) e posterior
- Fácil instalação e manutenção
- Inclui todos os acessórios necessários para instalação
- Válvula de descarga com vedante em silicone
- Com tubo de descarga Ø50 x Ø40 x 325 mm
- Fornecido em embalagem individual
- Em conformidade com a norma europeia (EN 14055)



REF.	COR - MODELO			€
BK0000001	BRANCO - 3/8"	1	5	29.50

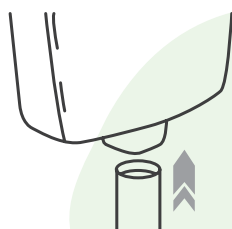

ENCAIXE RÁPIDO

O sistema de encaixe rápido do tubo de descarga que equipa os modelos lara e loca, permitem-lhe uma rápida fixação do tubo de descarga sem o recurso a quaisquer tipo de ferramentas ou vedações enquanto lhe garantem uma perfeita vedação nesta ligação.



TRÓPICO

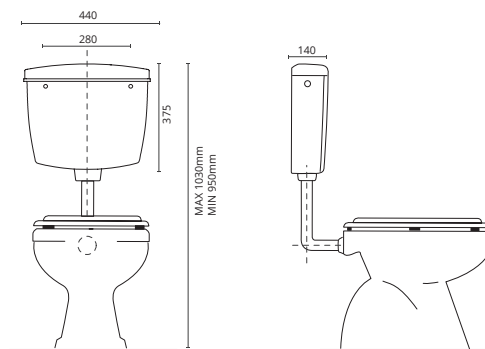

- Descarga interrumpível (até 6 litros)
- Fácil regulação do volume de descarga máxima entre 6l e 9l
- Entrada de água lateral (esquerda/direita) e posterior
- Fácil instalação e manutenção
- Inclui todos os acessórios necessários para instalação
- Válvula de descarga com vedante em silicone
- Com tubo de descarga Ø50 x Ø40 x 325 mm
- Fornecido em embalagem individual
- Em conformidade com a norma europeia (EN14055)



REF.	COR - MODELO			€
BK0000100	BRANCO - 3/8"	1	5	34.20

TRÓPICO ALTO

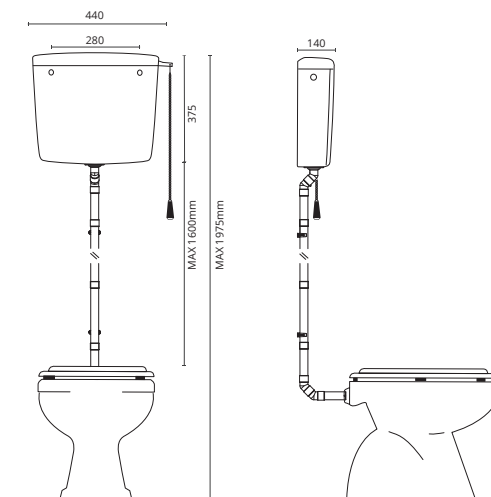

- Descarga interrumpível (até 6 litros)
- Fácil regulação do volume de descarga máxima entre 6l e 9l
- Sistema de encaixe rápido do tubo de descarga
- Entrada de água lateral (esquerda/direita) e posterior
- Fácil instalação e manutenção
- Inclui todos os acessórios necessários para instalação
- Válvula de descarga com vedante em silicone
- Fornecido com kit de tubos de descarga: 4 tubos - Ø50 x Ø32,5 x 400 mm
- Fornecido em embalagem individual
- Em conformidade com a norma europeia (EN14055)



REF.	COR - MODELO			€
BK0000150	BRANCO - COM TUBO - 3/8"	1	5	44.60

KOMBI

Fecho rápido e eficaz

Fácil ajuste da boia em altura

Fácil regulação

Tubo Telescópico para fácil ajuste em altura

Casquilho em latão 3/8"

2 EM 1

ENTRADA LATERAL OU ENTRADA INFERIOR

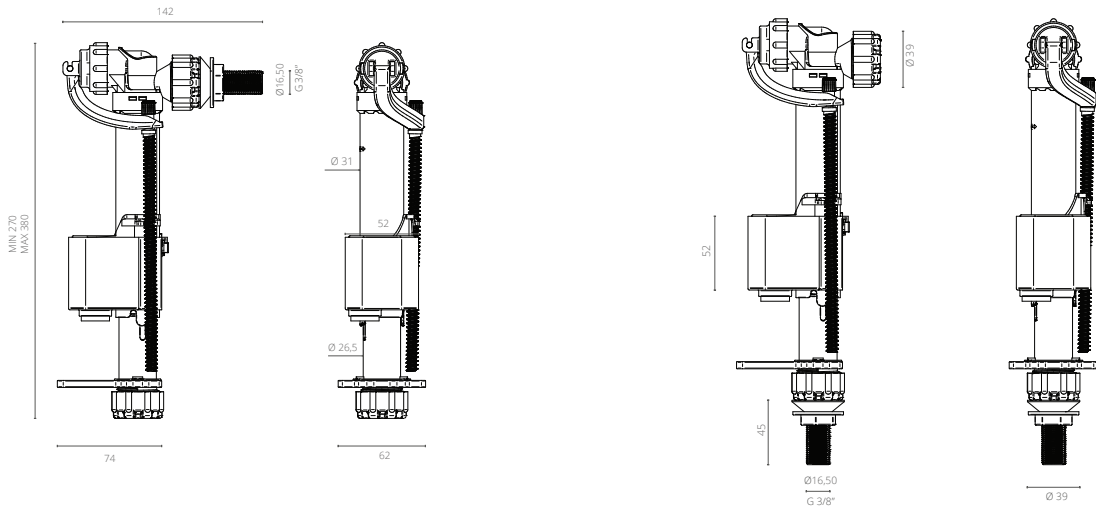

- Fácil ajuste em altura
- Entrada lateral orientável a 180°
- Enchimento rápido e silencioso
- Excelente desempenho com qualquer pressão de rede
- Sistema de entrada de água ultra-silencioso
- Casquilho em latão
- Fácil adaptação para torneira de boia de entrada de água lateral ou inferior

COMPACTA

Ideal para autoclismos de dimensões reduzidas

UNIVERSAL

Adapta-se facilmente a todos os autoclismos cerâmicos

REF.

BK0402000

MEDIDAS

3/8"

5

20

€

19.60

KOMPAKT

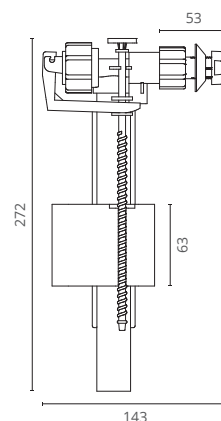

- Fácil ajuste em altura
- Entrada lateral orientável a 180°
- Enchimento rápido e silencioso
- Excelente desempenho com qualquer pressão de rede
- Sistema de entrada de água ultra-silencioso
- Casquilho em latão

REF.	MEDIDAS			€
BK0400100	3/8" -	5	20	16.40

TOP

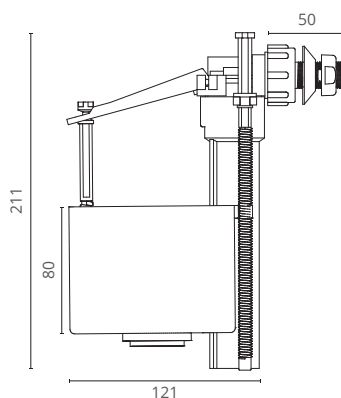

- Torneira boia de entrada de água lateral para autoclismos cerâmicos
- Enchimento rápido e silencioso
- Casquilho em latão

REF.	MEDIDAS			€
BK0400050	3/8" -	10	20	13.80
BK0400060	1/2" -	5	20	14.40

SIMPLEX

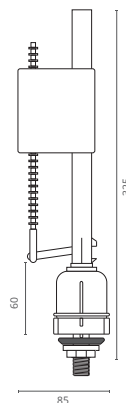

- Torneira boia de entrada de água inferior para autoclismos cerâmicos
- Enchimento rápido e silencioso
- Casquilho em latão
- Fácil ajuste em altura

REF.	MEDIDAS			€
BK0400500	3/8" -	10	20	12.20
BK0400540	1/2" -	5	20	12.80

A Ctesi® desenvolve os seus produtos para responder às necessidades dos instaladores e dos utilizadores finais. Com uma forte preocupação para a facilidade de instalação e manutenção enquanto desenvolvemos soluções que permitem substanciais poupanças de água.

A válvula de descarga **BI-FLASH** é compatível com a grande maioria dos reservatórios cerâmicos. Equipada com sistema de dupla descarga, esta válvula permite-lhe uma **poupança de água na ordem dos 50%**.

Fácil regulação em altura, sendo ajustável para reservatórios com altura interior entre 230 e 380 mm.



Botão com design pensado para incentivar à poupança de água, a parte mais saliente aciona a meia descarga levando assim o utilizador final a uma economia de água.

AJUSTE DA DESCARGA

DESCARGA COMPLETA

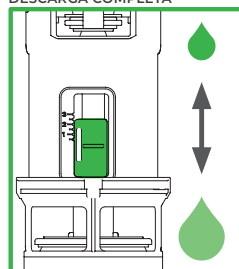

DESCARGA PARCIAL

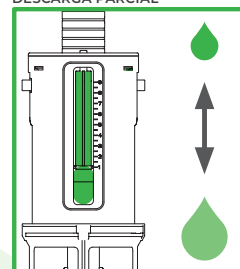

AJUSTE PARA CIMA PARA DESCARREGAR MENOS ÁGUA

Fácil ajuste da descarga total e da meia descarga. Pode facilmente ajustar o volume de água que pretende descarregar quer na descarga completa, quer na meia descarga de forma separada, fazendo com que um pequeno e rápido gesto lhe conceda uma enorme poupança de água.



O sistema de dupla descarga disponível nas válvulas de descarga Duo e Bi-Flash, permite-lhe escolher a quantidade de água que pretende em cada descarga, contribuindo com este gesto para uma **poupança de água de cerca de 50%**.



Botão de acionamento

Versatilidade - Aplicação do botão de accionamento universal e flexível. O accionamento por cabos permite-lhe colocar o botão na posição frontal, lateral ou superior, com uma enorme flexibilidade e facilidade de accionamento.

Tubo Telescópico

Fácil ajuste do tubo telescópico. Pode ajustar facilmente a altura do tubo de segurança de acordo com o volume de água pretendido para o seu reservatório cerâmico.



BI-FLASH

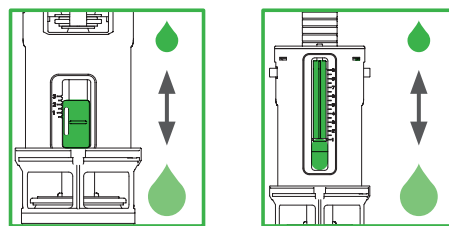
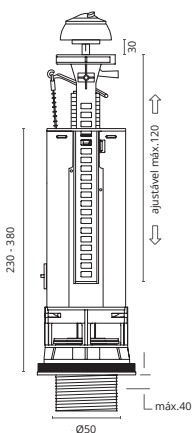

AJUSTE PARA CIMA PARA DESCARREGAR MENOS ÁGUA



- Válvula de dupla descarga para autoclismos cerâmicos
- Botão cromado para aplicação universal
- Fácil regulação do volume de descarga máximo
- Fácil regulação do volume da meia descarga
- Fácil e rápida instalação e ajuste em altura
- Botão ajustável em altura
- Inclui parafusos de fixação em aço inox para cisterna

REF.	MECANISMO			€
BK0410510	DUPLA DESCARGA -	5	20	18.20

DUO

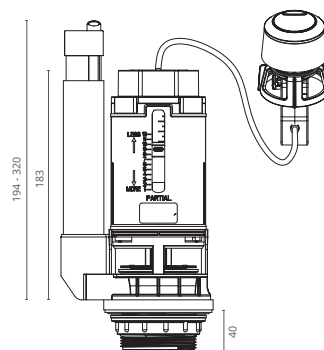

- Válvula de dupla descarga para autoclismos cerâmicos
- Botão cromado
- Fácil e rápida instalação e ajuste em altura
- Descarga regulável
- Posicionamento de botão ajustável para todo o tipo de cisternas
- Inclui parafusos de fixação em aço inox para cisterna

REF.	MECANISMO			€
BK0410500	DUPLA DESCARGA -	5	20	18.20

PRESS

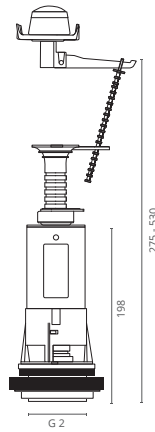

- Válvula de descarga simples para autoclismos cerâmicos
- Botão de premir cromado
- Fácil e rápida instalação e ajuste em altura
- Posicionamento de botão ajustável
- Inclui parafusos de fixação em aço inox para cisterna

REF.	MECANISMO			€
BK0410000	START / STOP -	10	20	16.20

PULL

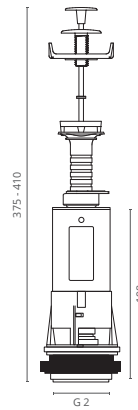

- Válvula de descarga simples para autoclismos cerâmicos
- Botão de puxar cromado
- Fácil e rápida instalação e ajuste em altura
- Posicionamento de botão ajustável
- Inclui parafusos de fixação em aço inox para cisterna

REF.	MECANISMO			€
BK0410100	PUXAR -	5	20	16.20



TUBO DESCARGA

REF.	MEDIDAS			€
BK1000000	Ø50 x Ø32 x 325 mm	1	20	4.20
BK1000010	Ø50 x Ø32 x 600 mm	1	30	11.90
BK1000020	Ø50 x Ø32 x 1000 mm	1	25	13.60
BK1000030	Ø50 x Ø40 x 350 mm	1	20	4.20

TUBO DESCARGA AJUSTÁVEL

REF.	MEDIDAS			€
BK1000150	Ø50 x Ø32 x 980 mm	1	20	23.20

TUBO DESCARGA P/ AUTOCLISMO ALTO

REF.	MEDIDAS			€
BK1000100	Ø32	1	20	21.00



PORCA P/ TUBO DESCARGA

REF.	DESIGNAÇÃO			€
BK1050010	5 UN	-	20	14.40

ANILHA P/ TUBO DESCARGA

REF.	DESIGNAÇÃO			€
BK1050020	10 UN	-	20	9.60



VEDANTE CÓNICO P/ TUBO DESCARGA

REF.	DESIGNAÇÃO			€
BK1050000	10 UN	-	20	6.40

VEDANTE VÁLVULA DESCARGA

REF.	DESIGNAÇÃO			€
BK1002000	10 UN	-	20	17.60



VEDANTE VÁLVULA / CISTERNA

REF.	MEDIDAS			€
BK1002100	85 x 57 x 8 - 5 UN	-	50	7.00

COMPATÍVEL COM TODAS AS LOUÇAS SANITÁRIAS



JUNTA DE VEDAÇÃO - CISTERNA / SANITA

REF.	MEDIDAS			€
BK1002110	110 x 70 x 20 - 5 UN	-	30	9.90

COMPATÍVEL COM TODAS AS VÁLVULAS DE DESCARGA



PORCA PLÁSTICA P/ CASQUILHO

REF.	MEDIDAS			€
BK1050100	LATERAL 3/8" - 10 UN	-	10	4.00
BK1050110	LATERAL 1/2" - 10 UN	-	10	4.00



PORCA PLÁSTICA P/ CASQUILHO

REF.	MEDIDAS			€
BK1050120	INFERIOR 3/8" - 10 UN	-	10	4.50
BK1050130	INFERIOR 1/2" - 10 UN	-	10	4.50



TAMPÃO PLÁSTICO LATERAL

REF.	MEDIDAS			€
BK1050200	3/8" - 10 UN	-	10	3.20
BK1050210	1/2" - 10 UN	-	10	3.20



TAMPÃO PLÁSTICO INFERIOR

REF.	MEDIDAS			€
BK1050220	3/8" - 5 UN	-	10	9.40
BK1050230	1/2" - 5 UN	-	10	9.90



VEDANTE INFERIOR TORNEIRA BOIA

REF.	MEDIDAS			€
BK1002200	3/8" - 10 UN	-	10	4.95
BK1002210	1/2" - 10 UN	-	10	5.30



BORRACHAS P/ KIT PARAFUSOS CISTERNA

REF.	DESIGNAÇÃO			€
BK1050320	10 UN	-	10	4.10

COMPATÍVEL COM TODAS AS LOUÇAS SANITÁRIAS



KIT 2 PARAFUSOS FIXAÇÃO CISTERNA

REF.	MEDIDAS			€
BK1050310	M6 x 80 - INOX	5	10	5.75

COMPATÍVEL COM TODAS AS LOUÇAS SANITÁRIAS



EMBOQUE SANITA INTERIOR

REF.	MEDIDAS			€
BK2006000	Ø32/40 - 10 UN	-	25	9.60



EMBOQUE SANITA INTERIOR

REF.	MEDIDAS			€
BK2006020	1" - 10 UN	-	10	15.10
BK2006021	1,1/4" - 10 UN	-	10	15.10

TUBOS EXTENSÍVEIS

Na Ctesi® encontra uma ampla gama de tubos extensíveis desenhados e testados para se adaptarem às exigentes condições de instalação e uso. Toda a gama foi concebida para uma rápida e simples instalação nas mais diferentes necessidades e configurações dos locais onde são aplicados. Devido à sua forma cônica, o tubo adapta-se perfeitamente a qualquer ligação, o que garante uma ótima vedação.



O **gancho duplo** foi desenvolvido para que possa facilmente criar sifão através da sua aplicação num tubo extensível Ctesi®.

A gama Ctesi® completa-se ainda com um leque alargado de opções de tubos extensíveis com acabamento cromado resultando assim numa oferta que alia a simplicidade de instalação, a funcionalidade e desempenho e uma oferta que se preocupa com a estética das suas instalações sanitárias.

TUBOS EXTENSÍVEIS COM GANCHO

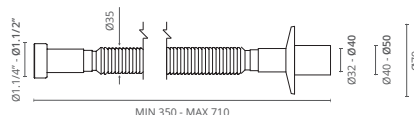

C/ PORCA

REF.	MEDIDAS			€
BK2001000	1,1/4" x 32/40	10	80	2,30
BK2001020	1,1/2" x 40/50	10	80	2,50

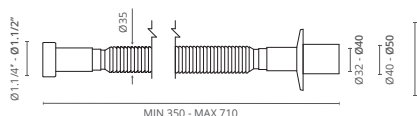

CÓNICO

REF.	MEDIDAS			€
BK2001100	1,1/4" x 32/40	10	80	2,50
BK2001120	1,1/2" x 40/50	10	80	2,80

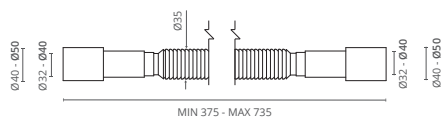

S/ PORCA

REF.	MEDIDAS			€
BK200000	32/40 x 32/40	10	100	1.70
BK200020	40/50 x 40/50	10	100	1.90

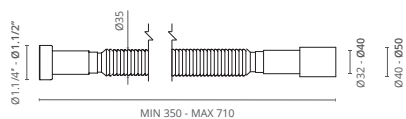

C/ PORCA

REF.	MEDIDAS			€
BK2000100	1/4" x 32/40	10	100	1.70
BK2000120	1/2" x 32/40	10	100	1.90
BK2000121	1/2" x 40/50	10	100	1.90

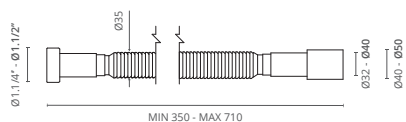

CÓNICO

REF.	MEDIDAS			€
BK2000400	1/4" x 32/40	10	100	1.95
BK2000421	1/2" x 40/50	10	100	2.25

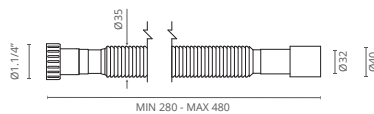

BIDÉ C/ PORCA

REF.	MEDIDAS			€
BK2000200	1/4" x 32/40	10	100	2.55

TUBOS EXTENSÍVEIS COM VÁLVULA

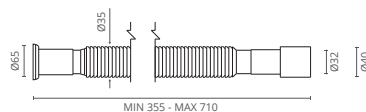

C/ VÁLVULA (ESPELHO Ø65)

REF.	MEDIDAS			€
BK2000500	32/40	10	80	4.80

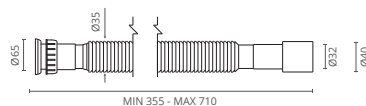

C/ VÁLVULA ROSCADA 1.1/4" (ESPELHO Ø65)

REF.	MEDIDAS			€
BK2000550	1.1/4" x 32/40	10	80	6.00

TUBOS EXTENSÍVEIS CROMADOS

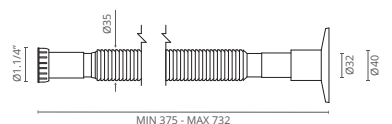

CROMADO C/ ESPELHO

REF.	MEDIDAS			€
BK2000600	1.1/4" x 32/40	10	100	5.30

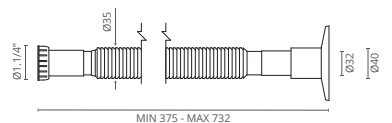

CÔNICO CROMADO C/ ESPELHO

REF.	MEDIDAS			€
BK2000700	1.1/4" x 32/40	10	100	5.60

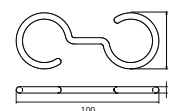
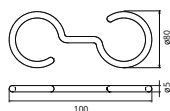

GANCHO CROMADO P/ TUBO EXTENSÍVEL

REF.	COR			€
BK2050110	CROMADO - 10 UN	-	20	6.00

GANCHO BRANCO P/ TUBO EXTENSÍVEL

REF.	COR			€
BK2050100	BRANCO - 10 UN	-	20	2.40

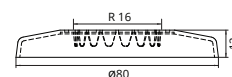
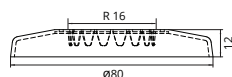

ESPELHO CROMADO P/ TUBO EXTENSÍVEL

REF.	MEDIDAS			€
BK2050210	Ø32 / 40 - 10 UN	-	20	7.20

ESPELHO BRANCO P/ TUBO EXTENSÍVEL

REF.	MEDIDAS			€
BK2050200	Ø32 / 40 - 10 UN	-	20	2.70



ANILHAS P/ TUBO EXTENSÍVEL

REF.	MEDIDAS			€
BK2050000	1 1/4" - 10 UN	-	50	5.10
BK2050010	1 1/2" - 10 UN	-	50	5.10

VEDANTE CÔNICO P/ TUBO EXTENSÍVEL

REF.	MEDIDAS			€
BK2050020	1 1/4" - 10 UN	-	50	5.10
BK2050030	1 1/2" - 10 UN	-	50	5.10

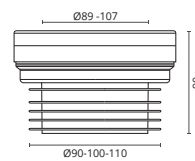

FLEXY CANHÃO SANITA DIREITO

REF.	MEDIDAS			€
BK2002200	Ø 90 / 100 / 110 mm	10	40	3.80

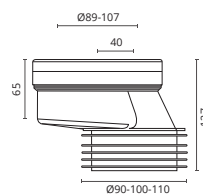

FLEXY EXCÊNTRICO SANITA 40 mm

REF.	MEDIDAS			€
BK2002220	Ø 90 / 100 / 110 mm - 40 mm	10	20	4.80

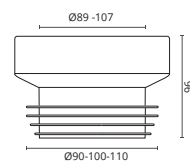

FITA CANHÃO SANITA DIREITO

REF.	MEDIDAS			€
BK2002000	Ø 90 / 100 / 110 mm	10	80	1.75

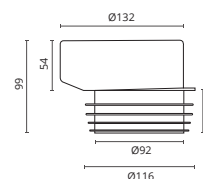

FITA EXCÊNTRICO SANITA 40 mm

REF.	MEDIDAS			€
BK2002100	Ø 90 / 100 / 110 mm - 40 mm	10	80	1.80

CURVAS SANITA

Especialmente indicada para fácil ligação ao chão em sanitas de descarga à parede.
Ajustável através de corte até 110 mm
Saída: Ø90/100/110 mm

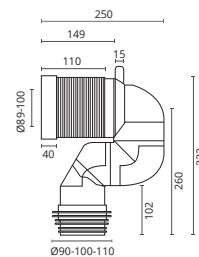
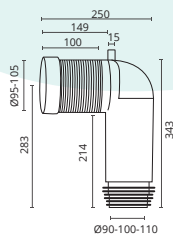
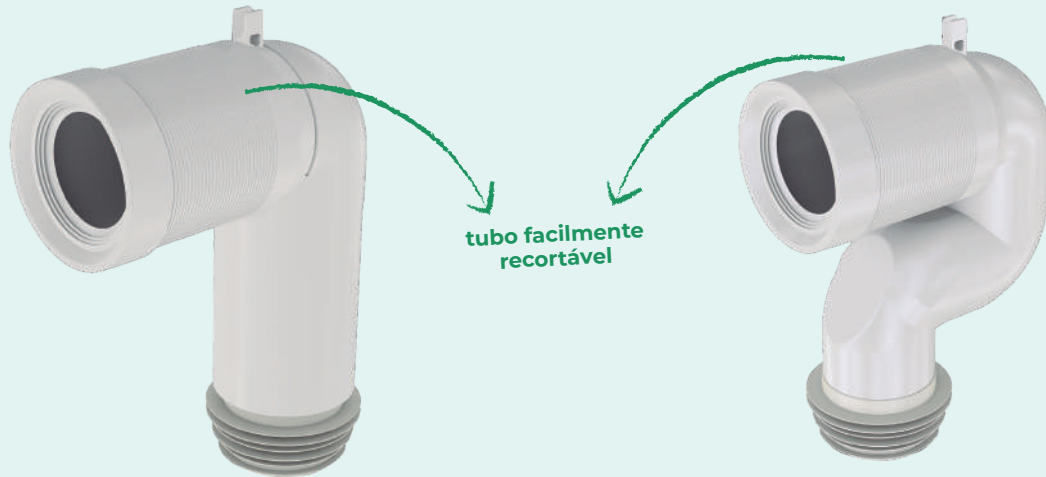

CURVA SANITA "90°"

REF.	MEDIDAS			€
BK2002820	Ø90/100/110 mm	2	20	17.80

CURVA SANITA "S"

REF.	MEDIDAS			€
BK2002800	Ø90/100/110 mm	2	20	17.80

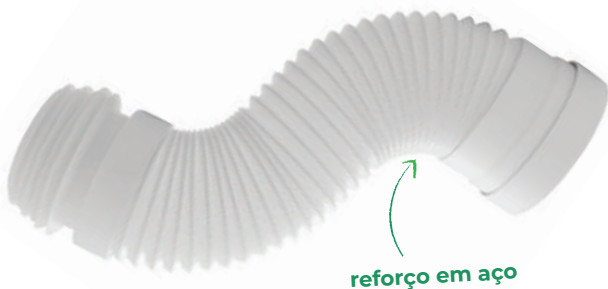

Resistente

- Parte extensível com inserção de aço
- Flexível de longa duração
- Não aderente a impurezas

Universal

- Borrachhas de vedação flexíveis em PVC
- Extensível de 30 a 55 cm
- Compatível com todas as sanitas



Ideal para renovação dada a facilidade de aplicação sem necessidade de retirar a sanita. Adapta-se a todas as configurações, mesmo as mais complexas.

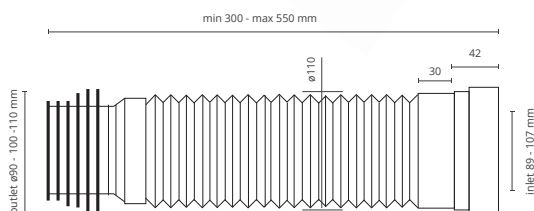

TUBO EXTENSÍVEL P/ SANITA

REF.	MEDIDAS			€
BK2002500	90/110 x 300/550 mm	5	30	9.80

ISOL

TELA IMPERMEABILIZANTE CARACTERÍSTICAS TÉCNICAS

	MÉTODO DE ENSAIO	RESULTADO
LARGURA (cm)	EN 1848-2	150 ± 2 cm
PESO (g/m ²)	EN 1849-2	240 ± 10 gr/m ²
COMPRIMENTO	EN 1848-2	30 metros / rolo
UM ROLO	-	45 m ²
PESO DE UM ROLO	-	9,5 kg / rolo ± 0,5
RESISTÊNCIA À DIFUSÃO DE VAPOR DE ÁGUA	EN 1931	Sd: < 6
ESTANQUIDADE	EN 1928	W1 Class
RESISTÊNCIA À RUPTURA TRANSVERSAL (NAIL SHANK)	EN 12310-1	295 N ± 30
RESISTÊNCIA À RUPTURA LONGITUDINAL (NAIL SHANK)	EN 12310-1	215 N ± 25
RESISTÊNCIA À TRACÇÃO TRANSVERSAL	EN 12311-1	575 N/5 cm ± 30 N/5 cm
RESISTÊNCIA À TRACÇÃO LONGITUDINAL	EN 12311-1	695 N/5 cm ± 40 N/5 cm
ALONGAMENTO LONGITUDINAL	EN 12311-1	45% ± 6%
ALONGAMENTO NA RUPTURA	EN 12311-1	48 ± 8%
RESISTÊNCIA À TEMPERATURA	-	-10°C / +60°C
REACÇÃO AO FOGO	EN 11925-2	Class E
COMPOSIÇÃO	-	PP/PU/PP
GARANTIA	Garantia do produto: 10 anos.	
CERTIFICADO DE ACORDO COM A NORMA	EN 13859-1	-
ARMAZENAMENTO	O produto deve ser armazenado num local fresco e seco, sem exposição à luz solar.	

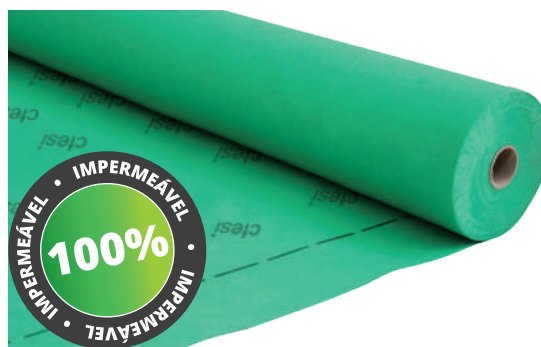
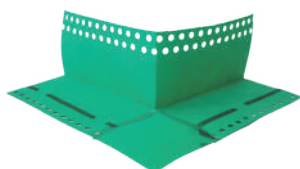
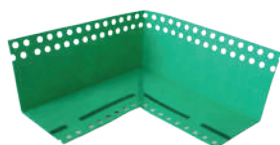

- ISOL é uma Tela Impermeabilizante de 3 camadas composta por PP/ PU/ PP (polipropileno/ poliuretano/ polipropileno)
- Recomenda-se a sua aplicação para impermeabilização sob cerâmica de pavimento e revestimento, e/ou bases de duche em casas de banho
- É 100% à prova d'água, flexível e fácil de aplicar
- Excelente aderência ao cimento
- Leve e simultaneamente bastante resistente
- Resistente e resiliente (conforme as normas EN12310 e EN12311)
- Resistente ao fogo (conforme norma EN11925)

TELA IMPERMEABILIZANTE

REF.	MEDIDAS			€
BK4029000	1,5 x 5 m	1	-	76.60
BK4029010	1,5 x 10 m	1	-	142.60
BK4029020	1,5 x 20 m	1	-	246.60
BK4029030	1,5 x 30 m	1	-	351.60

- Adesivo: borracha sintética
- TemperatWura de aplicação: 5°C
- Armazenamento: 15°C - 25°C por 18 meses sem expor a luz solar
- Aplicar a cola de azulejo Classe C2 por cima da fita
- Aplicar directamente na aba da calha de duche
- Para impermeabilização de calhas de duche

FITA ADESIVA PARA CALHAS DE DUCHE

REF.	MEDIDAS			€
BK4029550	3000 x 7,5 cm	1	-	58.60

- Fita para aplicação em juntas, pré-cortada, feita a partir da tela impermeabilizante
- Aplica-se para impermeabilização de juntas de parede e chão, limites horizontais ou verticais

ROLO DE FITA PARA JUNTAS

REF.	MEDIDAS			€
BK4029500	2500 x 12,5 cm	1	-	116.90

- Fita para aplicação em juntas, pré-cortada e impermeável
- Utiliza-se para a impermeabilização de cantos interiores em todas as áreas húmidas

CANTO IMPERMEÁVEL INTERIOR

REF.	MEDIDAS			€
BK4029200	12,5 x 12,5 x 6,25 cm	1	12	5.90

- Fita para aplicação em juntas, pré-cortada e impermeável
- Utiliza-se para a impermeabilização de cantos exteriores em todas as áreas húmidas

CANTO IMPERMEÁVEL EXTERIOR

REF.	MEDIDAS			€
BK4029220	12,5 x 12,5 x 6,25 cm	1	12	5.90

6 PASSOS PARA APLICAÇÃO DA TELA IMPERMEABILIZANTE ISOL

PREPARAÇÃO ANTES DA APLICAÇÃO

A superfície deve estar limpa, seca e sem substâncias granulares que impeçam a aderência



1 CORTE A TELA NAS MEDIDAS PRETENDIDAS
ISOL pode ser cortada em qualquer medida pretendida, de acordo com a área onde vai ser aplicada.



2 APLICAÇÃO DA COLA
A ISOL adere a superfícies horizontais e verticais com cola própria para azulejos de classe C2 TE S1. Este tipo de cola é aplicado diretamente na superfície com uma espátula dentada.

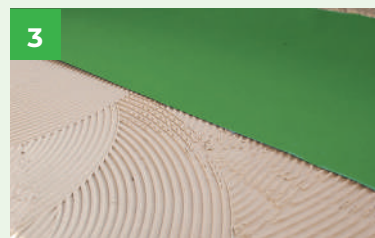

3 COLAGEM DA TELA
ISOL deve ser colocada de acordo com a direção do fluxo de água antes que a cola seque. Deve haver uma sobreposição de 10 cm nas juntas.

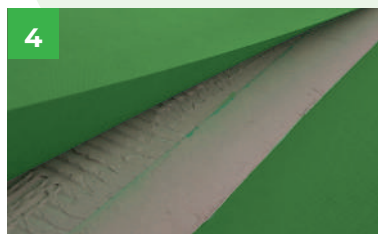

4 SOBREPÓSICÃO DE JUNTAS
10 cm. As sobreposições são coladas com cola de azulejos C2 TE S1. Para garantir uma melhor aderência, as bolhas de ar são removidas aplicando pressão com um lado plano da espátula.

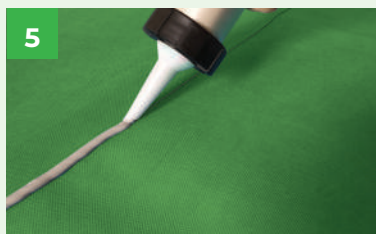

5 SELAGEM DE JUNTAS COM COLA POLIURETANO
As extremidades das juntas da tela devem ser seladas com mastique PU.



6 COBERTURA DA TELA
ISOL pode ser coberta com materiais de revestimento, como por exemplo a cerâmica.



PREPARAÇÃO DA SUPERFÍCIE

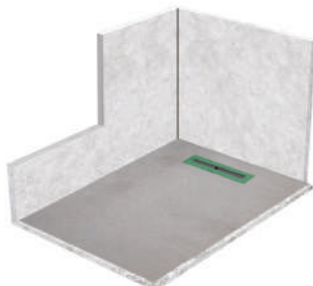

INSTALAÇÃO DA CALHA DE DUCHE

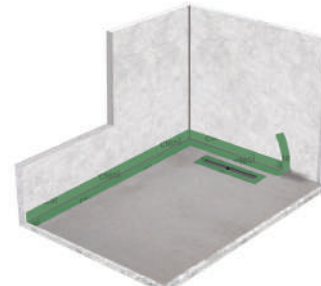

VEDAÇÃO HORIZONTAL DA PAREDE E CHÃO COM FITA PARA JUNTAS

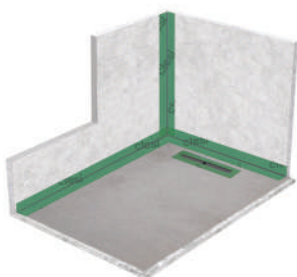

VEDAÇÃO VERTICAL DA PAREDE COM FITA PARA JUNTAS

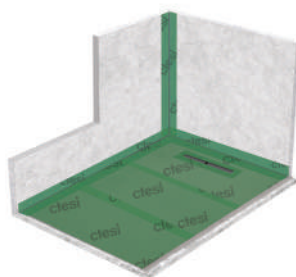

APLICAÇÃO DA TELA IMPERMEABILIZANTE ISOL NO CHÃO

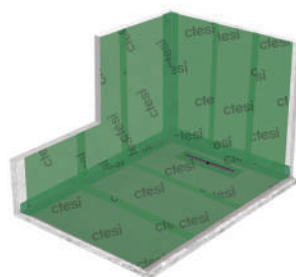

APLICAÇÃO DA TELA IMPERMEABILIZANTE ISOL NAS PAREDES

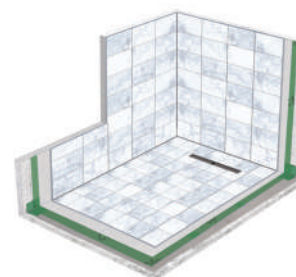

REVESTIMENTO APLICADO

A TELA IMPERMEABILIZANTE ISOL é indicada para o isolamento e vedação de bases de duche.

KITS CALHAS DE DUCHE

Os kits de calha de duche da Ctesi® são a opção para a construção de um espaço de banho com sistemas de drenagem eficiente.

Este kit é composto por uma calha de duche em polipropileno, grelha de aço inox, tela impermeabilizante ISOL com um 1,5 x 2 m para garantir o isolamento completo do espaço de banho e ainda uma cola apropriada para aplicação da tela.

Defina o seu espaço de banho e garanta o melhor sistema de drenagem com uma impermeabilização efetiva.

Todos os componentes do kit de calhas de duche têm a garantia da qualidade da Ctesi®.

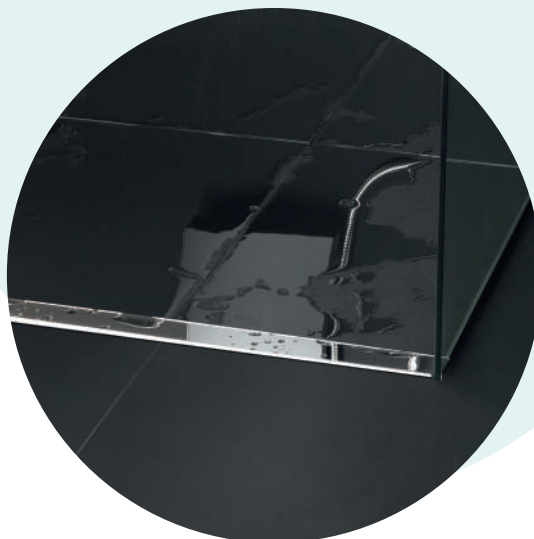

KIT WAY LINE

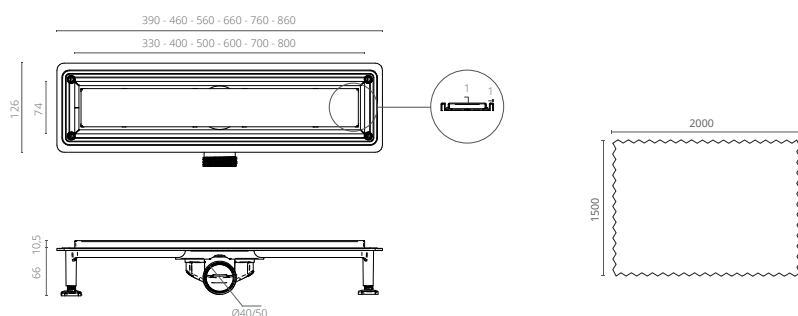
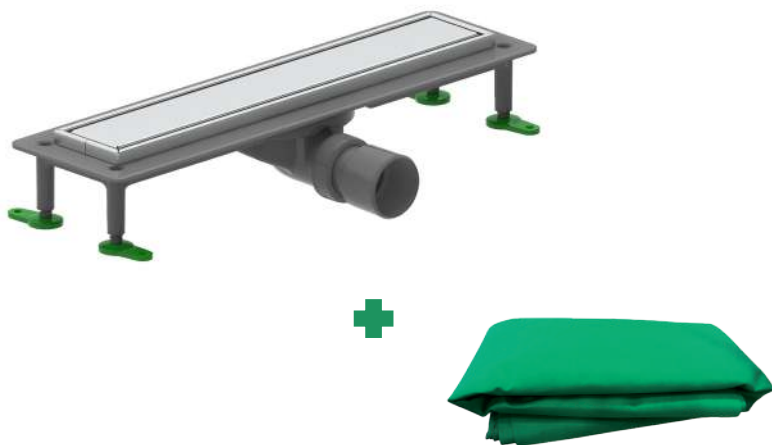

Personalize a grelha da calha com a mesma cerâmica utilizada no pavimento, para isso basta inverter a face da grelha e aplicar a cerâmica, que deve ter uma espessura de 6 mm.



- Calha de duche com corpo em polipropileno
- Grelha e Aro em aço inox AISI 304
- Inclui niveladores para melhor adaptabilidade
- Disponível nos comprimentos de 330, 400, 500, 600, 700 e 800 mm
- Largura de 60 mm
- Equipado com sistema anti-odores
- Para aplicação em espaços de duche
- Alta resistência química e a temperaturas entre -30C° +75C°

· Tela Impermeabilizante ISOL com 1,5 x 2m

KIT WAY LINE

REF.	MEDIDAS			€
BK4023200	330 x 60 mm	1	-	121.50
BK4023210	400 x 60 mm	1	-	128.20
BK4023220	500 x 60 mm	1	-	135.10
BK4023230	600 x 60 mm	1	-	142.00
BK4023240	700 x 60 mm	1	-	148.80
BK4023250	800 x 60 mm	1	-	155.60

KIT WAY SQUARE

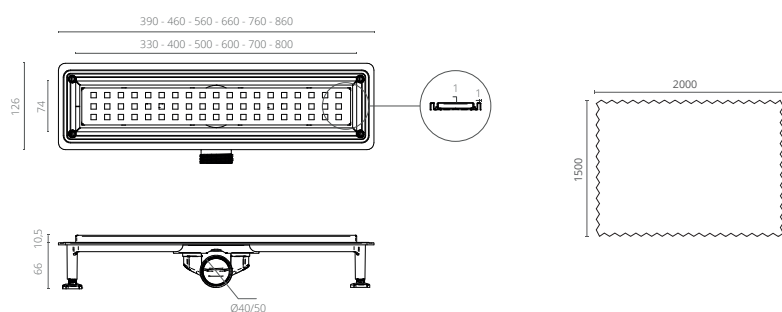

- Calha de duche com corpo em polipropileno
- Grelha e Aro em aço inox AISI 304
- Inclui niveladores para melhor adaptabilidade
- Disponível nos comprimentos de 330, 400, 500, 600, 700 e 800 mm
- Largura de 60 mm
- Equipado com sistema anti-odores
- Para aplicação em espaços de duche
- Alta resistência química e a temperaturas entre -30C° +75C°

· Tela Impermeabilizante ISOL com 1,5 x 2m

KIT WAY SQUARE

REF.	MEDIDAS			€
BK4023400	330 x 60 mm	1	-	121.50
BK4023410	400 x 60 mm	1	-	128.20
BK4023420	500 x 60 mm	1	-	135.10
BK4023430	600 x 60 mm	1	-	142.00
BK4023440	700 x 60 mm	1	-	148.80
BK4023450	800 x 60 mm	1	-	155.60

KIT WAY ROUND

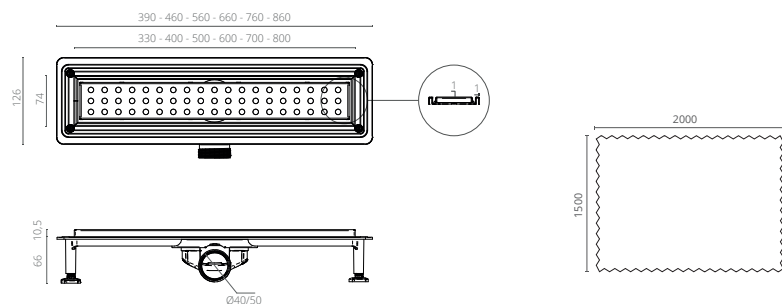

- Calha de duche com corpo em polipropileno
- Grelha e Aro em aço inox AISI 304
- Inclui niveladores para melhor adaptabilidade
- Disponível nos comprimentos de 330, 400, 500, 600, 700 e 800 mm
- Largura de 60 mm
- Equipado com sistema anti-odores
- Para aplicação em espaços de duche
- Alta resistência química e a temperaturas entre -30C° +75C°

· Tela Impermeabilizante ISOL com 1,5 x 2m

KIT WAY ROUND

REF.	MEDIDAS			€
BK4023600	330 x 60 mm	1	-	121.50
BK4023610	400 x 60 mm	1	-	128.20
BK4023620	500 x 60 mm	1	-	135.10
BK4023630	600 x 60 mm	1	-	142.00
BK4023640	700 x 60 mm	1	-	148.80
BK4023650	800 x 60 mm	1	-	155.60

CALHAS DE DUCHE

ESTÉTICA E EFICÁCIA

Com as calhas de duche Ctesi® damos-lhe a possibilidade de construir um espaço amplo e com livre acesso ao duche, numa perfeita simbiose entre a estética minimalista e uma drenagem eficiente.

As calhas de duche Ctesi® garantem uma drenagem rápida e eficaz enquanto conferem ao seu espaço de banho uma beleza ímpar, ocultando o sifão e possibilitando que o espaço de duche seja pavimentado com o material da sua eleição.

- Calhas de duche
- Fornecido com Tela Impermeabilizante ISOL, para melhor isolamento
- Inclui niveladores para melhor adaptabilidade
- Para aplicação em espaços de duche
- Disponível nos comprimentos de 330, 400, 500, 600, 700, 800, 900, 1000 e 1200 mm
- Equipadas com sistema anti-retorno de odores
- Alta resistência química e a temperaturas entre os -30°C e os +75°C

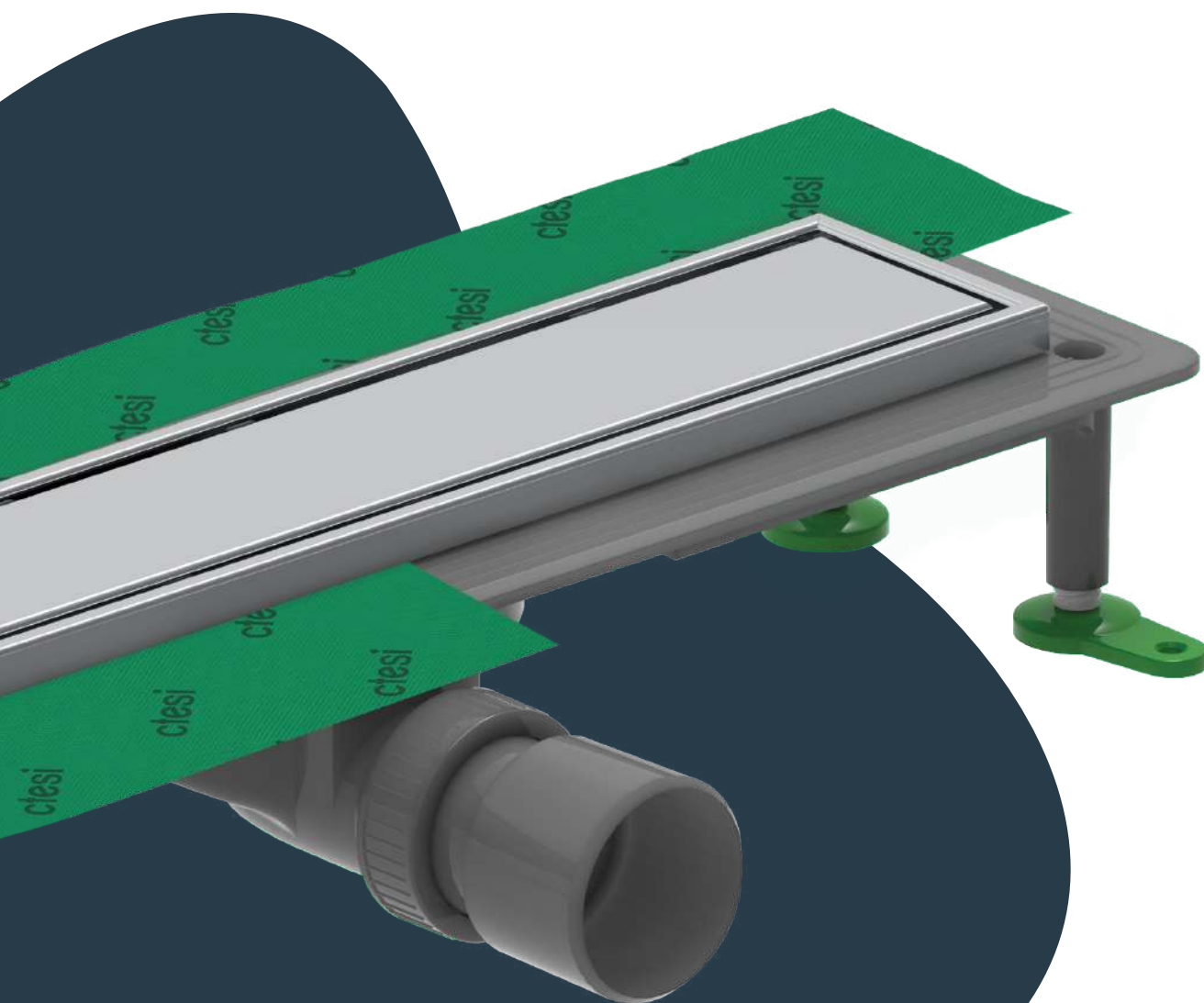
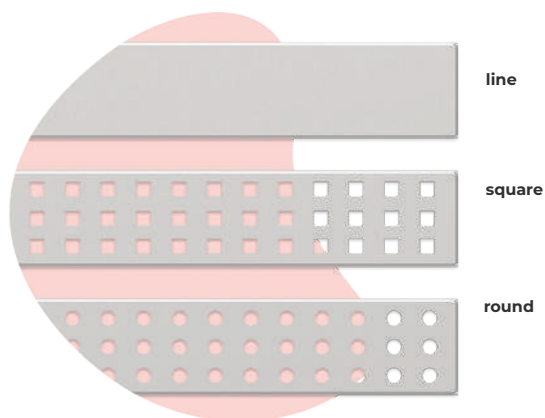

WAY LINE

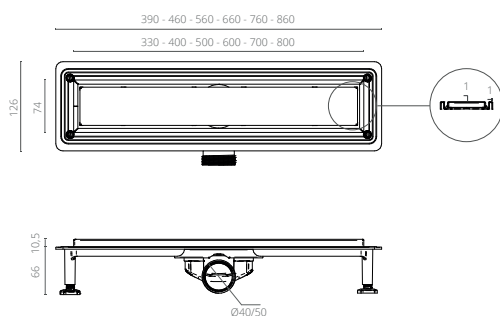
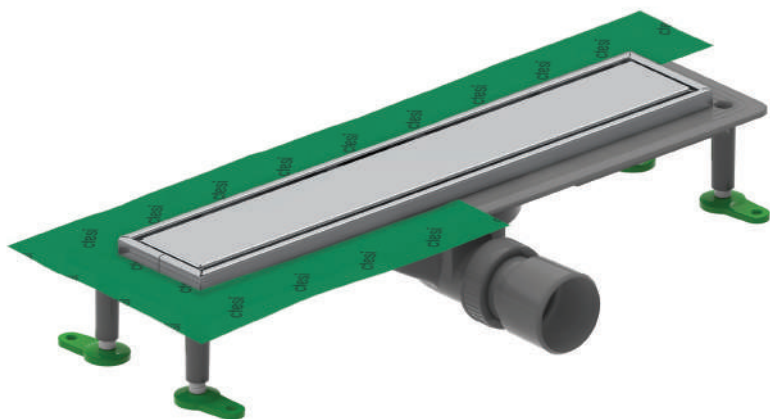

Personalize a grelha da calha com a mesma cerâmica utilizada no pavimento, para isso basta inverter a face da grelha e aplicar a cerâmica, que deve ter uma espessura de 6 mm.



- Calha de duche com corpo em polipropileno
- Grelha e Aro em aço inox AISI 304
- Fornecido com Tela Impermeabilizante ISOL
- Inclui niveladores para melhor adaptabilidade
- Para aplicação em espaços de duche
- Disponível nos comprimentos de 330, 400, 500, 600, 700 e 800 mm
- Largura de 60 mm
- Equipado com sistema anti-odores
- Alta resistência química e a temperaturas entre -30°C +75°C

WAY LINE

REF.	MEDIDAS			€
BK4024000	330 x 60 mm	1	-	86.20
BK4024010	400 x 60 mm	1	-	94.80
BK4024020	500 x 60 mm	1	-	103.40
BK4024030	600 x 60 mm	1	-	112.00
BK4024040	700 x 60 mm	1	-	120.60
BK4024050	800 x 60 mm	1	-	130.90

FLOW LINE

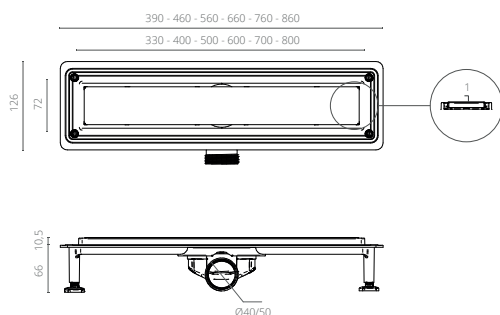
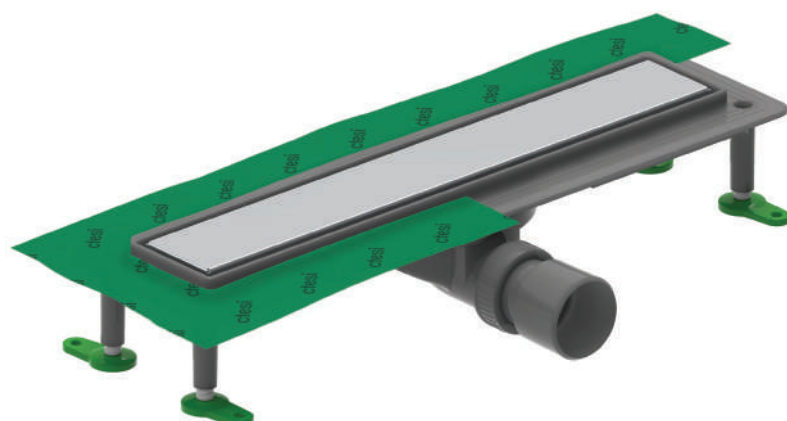

- Calha de duche com corpo em polipropileno
- Grelha em aço inox AISI 304
- Fornecido com Tela Impermeabilizante ISOL
- Inclui niveladores para melhor adaptabilidade
- Para aplicação em espaços de duche
- Disponível nos comprimentos de 330, 400, 500, 600, 700 e 800 mm
- Largura de 60 mm
- Equipado com sistema anti-odores
- Alta resistência química e a temperaturas entre -30°C +75°C

FLOW LINE

REF.	MEDIDAS			€
BK4024500	330 x 60 mm	1	-	69.30
BK4024510	400 x 60 mm	1	-	77.40
BK4024520	500 x 60 mm	1	-	85.60
BK4024530	600 x 60 mm	1	-	93.70
BK4024540	700 x 60 mm	1	-	101.90
BK4024550	800 x 60 mm	1	-	106.20

WAY SQUARE

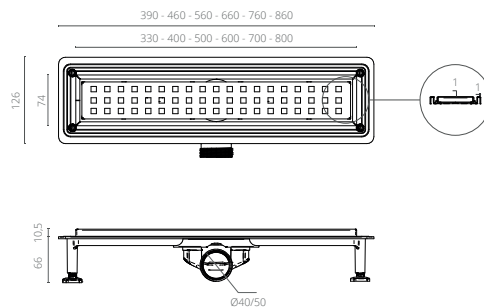

- Calha de duche com corpo em polipropileno
- Grelha e Aro em aço inox AISI 304
- Fornecido com Tela Impermeabilizante ISOL
- Inclui niveladores para melhor adaptabilidade
- Para aplicação em espaços de duche
- Disponível nos comprimentos de 330, 400, 500, 600, 700 e 800 mm
- Largura de 60 mm
- Equipado com sistema anti-odores
- Alta resistência química e a temperaturas entre -30°C +75°C

WAY SQUARE

REF.	MEDIDAS			€
BK4024100	330 x 60 mm	1	-	86.20
BK4024110	400 x 60 mm	1	-	94.80
BK4024120	500 x 60 mm	1	-	103.40
BK4024130	600 x 60 mm	1	-	112.00
BK4024140	700 x 60 mm	1	-	120.60
BK4024150	800 x 60 mm	1	-	130.90

FLOW SQUARE

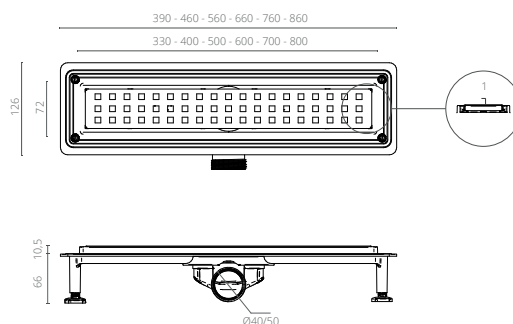

- Calha de duche com corpo em polipropileno
- Grelha em aço inox AISI 304
- Fornecido com Tela Impermeabilizante ISOL
- Inclui niveladores para melhor adaptabilidade
- Para aplicação em espaços de duche
- Disponível nos comprimentos de 330, 400, 500, 600, 700 e 800 mm
- Largura de 60 mm
- Equipado com sistema anti-odores
- Alta resistência química e a temperaturas entre -30°C +75°C

FLOW SQUARE

REF.	MEDIDAS			€
BK4024600	330 x 60 mm	1	-	69.30
BK4024610	400 x 60 mm	1	-	77.40
BK4024620	500 x 60 mm	1	-	85.60
BK4024630	600 x 60 mm	1	-	93.70
BK4024640	700 x 60 mm	1	-	101.90
BK4024650	800 x 60 mm	1	-	106.20

WAY ROUND

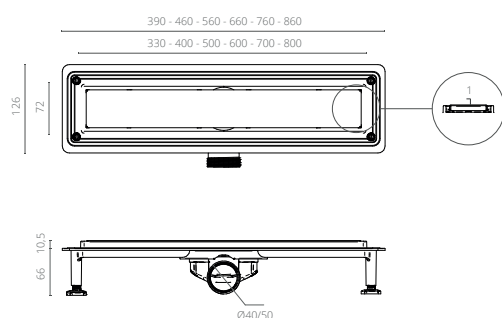

- Calha de duche com corpo em polipropileno
- Grelha e Aro em aço inox AISI 304
- Fornecido com Tela Impermeabilizante ISOL
- Inclui niveladores para melhor adaptabilidade
- Para aplicação em espaços de duche
- Disponível nos comprimentos de 330, 400, 500, 600, 700 e 800 mm
- Largura de 60 mm
- Equipado com sistema anti-odores
- Alta resistência química e a temperaturas entre -30°C +75°C

WAY ROUND

REF.	MEDIDAS			€
BK4024200	330 x 60 mm	1	-	86.20
BK4024210	400 x 60 mm	1	-	94.80
BK4024220	500 x 60 mm	1	-	103.40
BK4024230	600 x 60 mm	1	-	112.00
BK4024240	700 x 60 mm	1	-	120.60
BK4024250	800 x 60 mm	1	-	130.90

FLOW ROUND

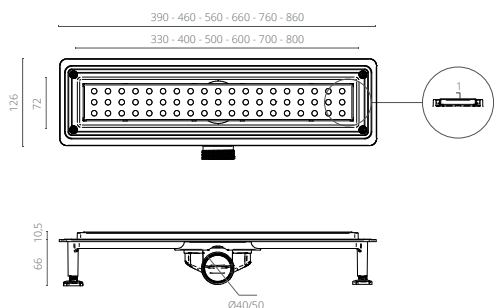

- Calha de duche com corpo em polipropileno
- Grelha em aço inox AISI 304
- Fornecido com Tela Impermeabilizante ISOL
- Inclui niveladores para melhor adaptabilidade
- Para aplicação em espaços de duche
- Disponível nos comprimentos de 330, 400, 500, 600, 700 e 800 mm
- Largura de 60 mm
- Equipado com sistema anti-odores
- Alta resistência química e a temperaturas entre -30°C +75°C

FLOW ROUND

REF.	MEDIDAS			€
BK4024700	330 x 60 mm	1	-	69.30
BK4024710	400 x 60 mm	1	-	77.40
BK4024720	500 x 60 mm	1	-	85.60
BK4024730	600 x 60 mm	1	-	93.70
BK4024740	700 x 60 mm	1	-	101.90
BK4024750	800 x 60 mm	1	-	106.20

PETRA & DRAIN

VÁLVULAS DE DUCHE

PARA UMA DRENAGEM RÁPIDA E EFICAZ

As válvulas de duche Ctesi® foram desenhadas para permitir uma rápida e simples instalação e um fácil acesso para manutenção, garantindo uma drenagem perfeita em qualquer tipo de instalação.

O sistema de retenção de impurezas evita o arrastamento da sujidade para a rede de drenagem, enquanto contribui como anti-retorno dos odores.

As grelhas em ABS cromado e com design moderno são o acabamento perfeito para embelezar a sua base de duche.



Filtro "Anti-Cabelos"
de fácil acesso pelo utilizador final

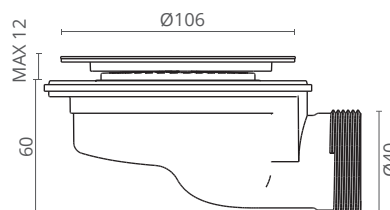

- Inclui aro em aço inox para fixação na base de duche
- Altura reduzida: ideal para bases de duche extraplanas
- Higiénica: equipada com sistema anti-retorno (de águas e odores)
- Prática: fácil retirada de filtro anti-cabelos por parte do utilizador final
- Drenagem Eficaz: caudal bastante superior aos critérios exigidos na EN-274 (> 24L/min)
- Inovadora: sistema de drenagem inovador (Pedido de Patente: Depositado)
- Saída: Ø40 mm (interior) ou 1.1/2" (exterior)
- Entrada: para furação Ø90 mm



PETRA VÁLVULA DE DUCHE

REF.	MEDIDAS			€
BK4000360	Ø106 mm	1	50	22.10

INDICADO PARA BASES DE DUCHE MINERAIS EXTRAPLANAS | FURAÇÃO Ø90

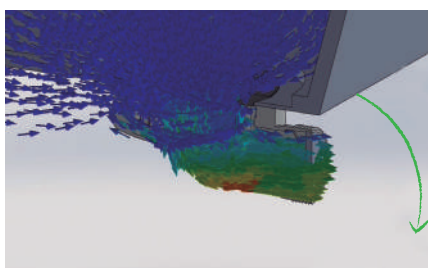
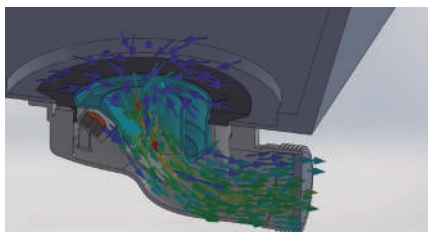

SISTEMA INOVADOR CAUDAL DE DRENAGEM ELEVADO

Velocidade de fluxo bem acima dos critérios exigidos pela norma europeia EN-274 (> 24L / min)

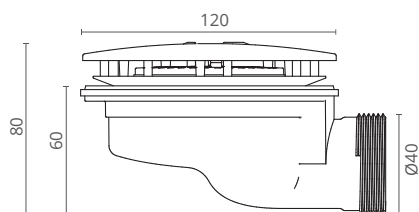

Filtro "Anti-Cabelos"
de fácil acesso pelo utilizador final



- Altura reduzida: ideal para bases de duche extraplanas
- Higiénica: equipada com sistema anti-retorno (de águas e odores)
- Prática: fácil retirada de filtro anti-cabelos por parte do utilizador final
- Drenagem Eficaz: caudal bastante superior aos critérios exigidos na EN-274 (> 24L/min)
- Inovadora: sistema de drenagem inovador (Pedido de Patente: Depositado)
- Tampa Ø120mm
- Saída: Ø40 mm (interior) ou 1.1/2" (exterior)
- Entrada: para furação Ø90 mm

DRAIN VÁLVULA DE DUCHE

REF.	MEDIDAS	COR			€
BK4000350	Ø120 mm	CROMADO	1	50	19,70

INDICADO PARA BASES DE DUCHE EXTRAPLANAS | FURAÇÃO Ø90

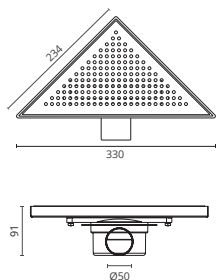
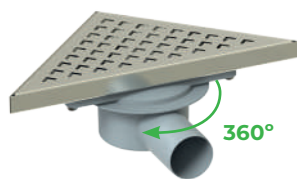

- Sifão de pavimento com corpo em PVC com rotação 360°
- Grelha em aço inox AISI 304
- Com anti-retorno de odores
- Para aplicação em espaços de duche

SQUARE
SIFÃO DE PAVIMENTO

REF.	MEDIDAS			€
BK4020511	230 x 230 - Ø50 mm	1	8	50.50

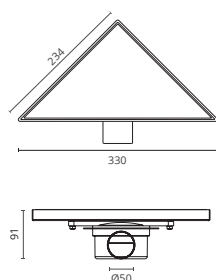
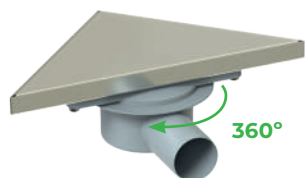

- Sifão de pavimento com corpo em PVC com rotação 360°
- Grelha em aço inox AISI 304
- Com anti-retorno de odores
- Para aplicação em espaços de duche

LINE
SIFÃO DE PAVIMENTO

REF.	MEDIDAS			€
BK4020611	230 x 230 - Ø50 mm	1	8	50.50

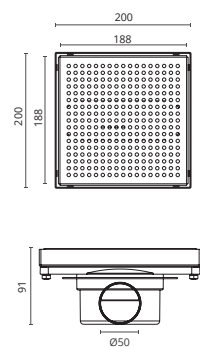
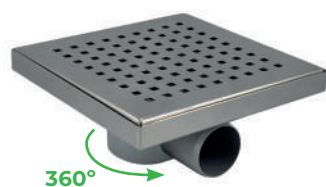

- Sifão de pavimento com corpo em PVC com rotação 360°
- Grelha em aço inox AISI 304
- Com anti-retorno de odores
- Para aplicação em espaços de duche

SQUARE
SIFÃO DE PAVIMENTO

REF.	MEDIDAS			€
BK4020501	200 x 200 - Ø50 mm	1	8	68.10

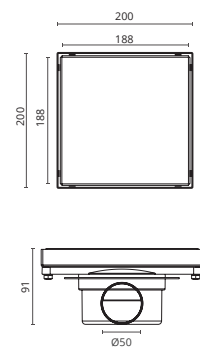
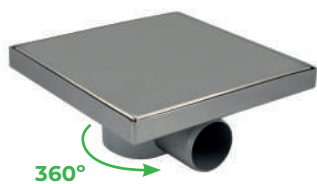

- Sifão de pavimento com corpo em PVC com rotação 360°
- Grelha em aço inox AISI 304
- Com anti-retorno de odores
- Para aplicação em espaços de duche

LINE
SIFÃO DE PAVIMENTO

REF.	MEDIDAS			€
BK4020601	200 x 200 - Ø50 mm	1	8	68.10

ALTURA AJUSTÁVEL / SAÍDA ORIENTÁVEL

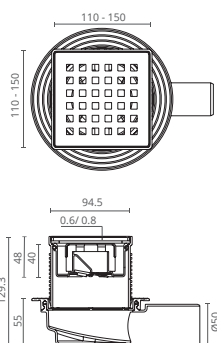
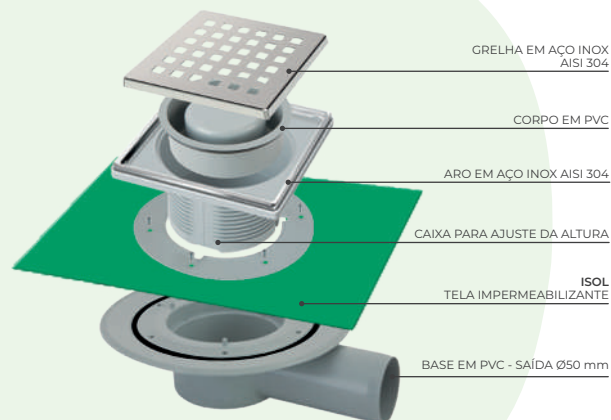
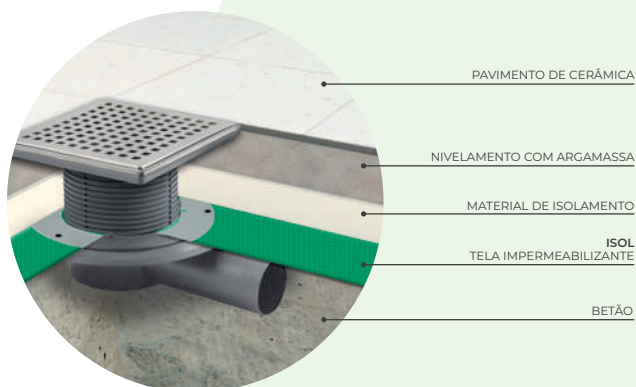

- Sifão de pavimento com corpo em PVC
- Grelha em aço inox AISI 304
- Altura ajustável / saída orientável
- Indicado para isolamento e impermeabilização da água
- Com anti-retorno de odores
- Para aplicação em espaços de duche
- Tela Impermeabilizante ISOL com 1,5 x 2m

KIT SQUARE

SIFÃO AJUSTÁVEL COM TELA IMPERMEABILIZANTE

REF.	MEDIDAS			€
BK4021000	100 x 100 x Ø50 mm	1	6	54.70
BK4021010	150 x 150 x Ø50 mm	1	6	57.60

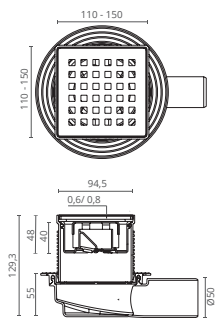

- Sifão de pavimento com corpo em PVC
- Grelha em aço inox AISI 304
- Altura ajustável / saída orientável
- Indicado para isolamento e impermeabilização da água
- Com anti-retorno de odores
- Para aplicação em espaços de duche, varandas, terraços e/ou caves
- Aplicado à altura do pavimento

SQUARE

SIFÃO CHÃO HORIZONTAL

REF.	MEDIDAS			€
BK4020200	110 x 110 x Ø50 mm	1	24	19.20
BK4020210	150 x 150 x Ø50 mm	1	24	22.90

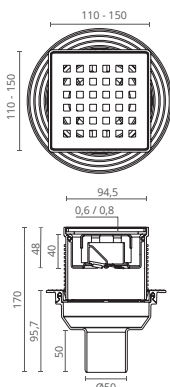

- Sifão de pavimento com corpo em PVC
- Grelha em aço inox AISI 304
- Altura ajustável
- Indicado para isolamento e impermeabilização da água
- Com anti-retorno de odores
- Para aplicação em espaços de duche, varandas, terraços e/ou caves
- Aplicado à altura do pavimento

SQUARE
SIFÃO CHÃO VERTICAL

REF.	MEDIDAS			€
BK4020205	110 x 110 x Ø50 mm	1	24	19.20
BK4020215	150 x 150 x Ø50 mm	1	24	22.90

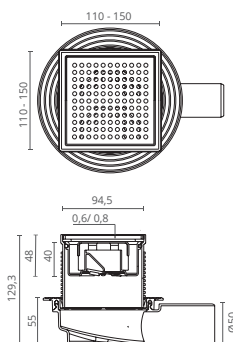
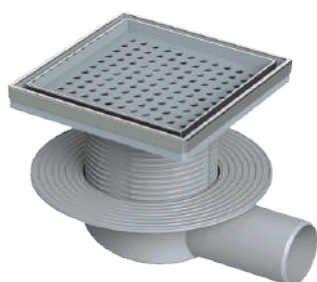

- Sifão de pavimento com corpo em PVC
- Aro em aço inox AISI 304
- Altura ajustável / saída orientável
- Com anti-retorno de odores
- Para aplicação em espaços de duche, varandas, terraços e/ou caves
- Para aplicação com cerâmica (máx. 7 mm)

SQUARE
SIFÃO CHÃO HORIZONTAL P/ CERÂMICA

REF.	MEDIDAS			€
BK4020250	110 x 110 x Ø50 mm	1	24	20.40
BK4020260	150 x 150 x Ø50 mm	1	24	23.50

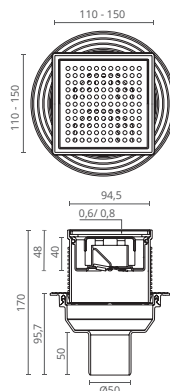

- Sifão de pavimento com corpo em PVC
- Aro em aço inox AISI 304
- Altura ajustável
- Com anti-retorno de odores
- Para aplicação em espaços de duche, varandas, terraços e/ou caves
- Para aplicação com cerâmica (máx. 7 mm)

SQUARE
SIFÃO CHÃO VERTICAL P/ CERÂMICA

REF.	MEDIDAS			€
BK4020255	110 x 110 x Ø50 mm	1	24	20.40
BK4020265	150 x 150 x Ø50 mm	1	24	23.50

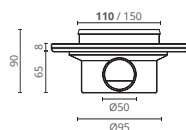

- Sifão de pavimento com corpo em PVC
- Grelha em aço inox AISI 304
- Saída orientável
- Com anti-retorno de odores
- Para aplicação em espaços de duche, varandas, terraços e/ou caves

SQUARE

SIFÃO CHÃO HORIZONTAL P/ REMATE

REF.	MEDIDAS			€
BK4020300	110 x 110 x Ø50 mm	1	24	22.10
BK4020310	150 x 150 x Ø50 mm	1	24	29.10

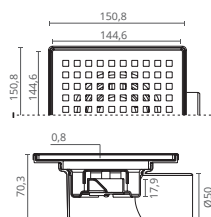

- Sifão de pavimento com corpo em PVC
- Grelha em aço inox AISI 304
- Saída orientável
- Com anti-retorno de odores
- Para aplicação em espaços de duche, varandas, terraços e/ou caves

SQUARE

SIFÃO CHÃO HORIZONTAL

REF.	MEDIDAS			€
BK4020000	110 x 110 x Ø50 mm	1	40	7.80
BK4020010	150 x 150 x Ø50 mm	1	20	11.20

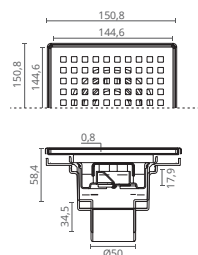

- Sifão de pavimento com corpo em PVC
- Grelha em aço inox AISI 304
- Com anti-retorno de odores
- Para aplicação em espaços de duche, varandas, terraços e/ou caves

SQUARE

SIFÃO CHÃO VERTICAL

REF.	MEDIDAS			€
BK4020100	100 x 100 x Ø50 mm	1	45	7.80
BK4020110	150 x 150 x Ø50 mm	1	28	11.20

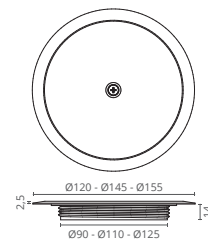
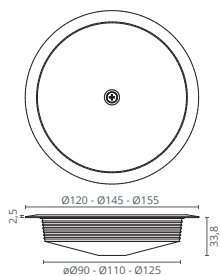

EXPANSÃO INOX AISI 304

REF.	MEDIDAS			€
BK2010600	Ø90 mm	1	60	3,95
BK2010601	Ø110 mm	1	50	4,75
BK2010602	Ø125 mm	1	30	6,40

AÇO INOX POLIDO AISI 304

REF.	MEDIDAS			€
BK2010200	Ø90 mm	1	100	2,70
BK2010201	Ø110 mm	1	50	3,40
BK2010202	Ø125 mm	1	30	5,70

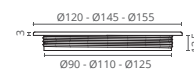
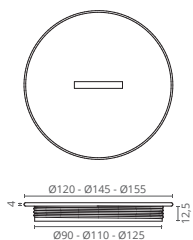

ABS

REF.	MEDIDAS			€
BK2010000	Ø90 mm	1	250	1,90
BK2010001	Ø110 mm	1	200	2,30
BK2010002	Ø125 mm	1	150	3,70

AÇO INOX AISI 304

REF.	MEDIDAS			€
BK2010100	Ø90 mm	1	150	2,60
BK2010101	Ø110 mm	1	50	3,20
BK2010102	Ø125 mm	1	40	4,90

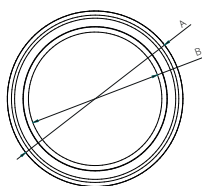

DIMENSÕES (mm)		
SIFÃO	A	B
Ø90 mm	Ø120,75	Ø91,75
Ø110 mm	Ø137,75	Ø108,75
Ø125 mm	Ø157,75	Ø128,75

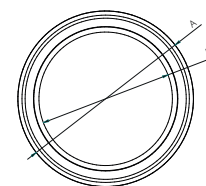

DIMENSÕES (mm)		
SIFÃO	A	B
Ø90 mm	Ø120,75	Ø91,75
Ø110 mm	Ø137,75	Ø108,75
Ø125 mm	Ø157,75	Ø128,75

ABS

AROS P/ SIFÃO

REF.	MEDIDAS			€
BK2011000	Ø90 mm	1	250	1,60
BK2011001	Ø110 mm	1	200	1,90
BK2011002	Ø125 mm	1	160	2,40

AÇO INOX AISI 304

AROS P/ SIFÃO

REF.	MEDIDAS			€
BK2011100	Ø90 mm	1	250	2,60
BK2011101	Ø110 mm	1	150	3,10
BK2011102	Ø125 mm	1	250	5,20



PERSIANA BRANCO

REF.	MEDIDAS			€
BK2008000	12 x 12 cm	10	25	0.80
BK2008005	15 x 15 cm	10	25	0.86
BK2008010	20 x 20 cm	10	50	1.55



PERSIANA BRANCO

REF.	MEDIDAS			€
BK2008020	25 x 25 cm	10	30	2.30
BK2008030	30 x 30 cm	10	30	3.10
BK2008040	40 x 40 cm	10	15	5.91



C/ REGULADOR GIRATÓRIO BRANCO

REF.	MEDIDAS			€
BK2008200	12 x 12 cm	10	60	0.96
BK2008205	15 x 15 cm	10	50	1.07



CIRCULAR BRANCO

REF.	MEDIDAS			€
BK2008300	Ø 12 cm	10	40	1.37
BK2008305	Ø 14 cm	10	25	1.64



PERSIANA RECTANGULAR BRANCO

REF.	MEDIDAS			€
BK2008015	25 x 10 cm	-	10	1.55



PERSIANA RECTANGULAR BRANCO

REF.	MEDIDAS			€
BK2008025	30 x 15 cm	10	30	2.06
BK2008035	40 x 20 cm	10	40	3.10

DUCHETA CROMADA

MAIS CONFORTO MAIS HIGIENE

As duchetas higiénicas Ctesi® proporcionam-lhe mais conforto na sua higiene pessoal e são indicadas para substituir os bidés quando aplicadas junto da sanita.

Podem ser ligadas a um ponto de água com torneira de esquadria e funcionar inclusive com 2 águas quando é aplicada uma válvula misturadora antes da ducheta. Existem ainda aplicações alternativas, como seja, por exemplo, a aplicação em pet shops ou locais semelhantes para a higiene do seu animal de estimação.

Máxima higiene e conforto num modelo que se destaca pela excelência do seu desempenho.



DUCHETA CROMADA

REF.	DESCRIÇÃO			€
BK5012001	KIT DUCHETA	1	40	15.70
BK5012201	DUCHETA	5	100	9.00
BK5012401	SUPORTE	5	100	2.20
BK5012601	BICHA - 125 cm	10	100	6.90

DUCHETA BRANCA

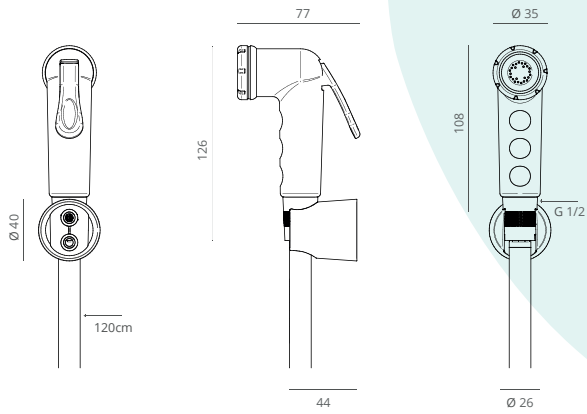

DUCHETA BRANCA

REF.	DESCRIÇÃO			€
BK5012000	KIT DUCHETA	1	40	8.70
BK5012200	DUCHETA	5	100	4.20
BK5012400	SUPORTE	5	100	1.10
BK5012600	BICHA - 120 cm	10	100	3.20

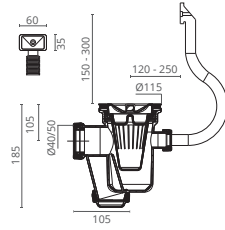

SIFÃO GORDURA C/ AVISADOR

REF.	MEDIDAS			€
BK2012505	Ø115 x 40/50 - CAIXA	5	14	19.80

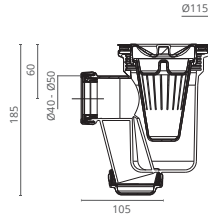

SIFÃO GORDURA

REF.	MEDIDAS			€
BK2012500	Ø115 x 40/50 - CAIXA	5	14	17.60

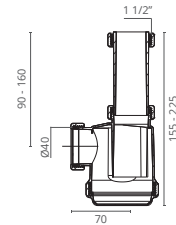

SIMPLES S/ VÁLVULAS

REF.	MODELO			€
BK2012000	SS-01 *	5	70	3.37

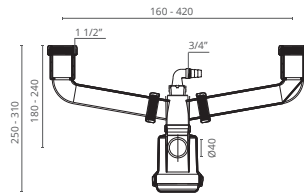

DUPLO S/ VÁLVULAS

REF.	MODELO			€
BK2012200	SD-01 *	5	25	7.60

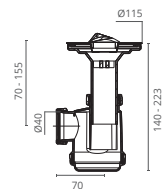

SIMPLES C/ VÁLVULAS

REF.	MODELO			€
BK2012010	SS-02 *	5	50	5.25

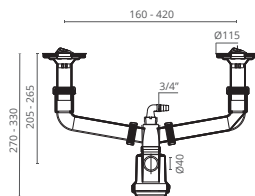

DUPLO C/ VÁLVULAS

REF.	MODELO			€
BK2012210	SD-02 *	5	18	12.25

* ARTIGO FORNECIDO EM SACO DE PLÁSTICO

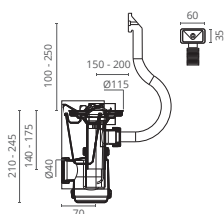

SIMPLES C/ VÁLVULA C/ AVISADOR

REF.	MODELO			€
BK2012020	SS-03*	5	36	7.70

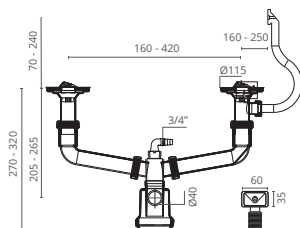

DUPLO C/ VÁLVULAS E AVISADOR

REF.	MODELO			€
BK2012220	SD-03*	5	15	14.60

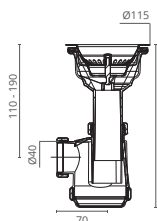

SIMPLES C/ VÁLVULA CESTO

REF.	MODELO			€
BK2012030	SS-05*	5	35	8.70

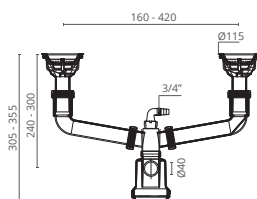

DUPLO C/ VÁLVULAS CESTO

REF.	MODELO			€
BK2012230	SD-05*	5	15	19.60

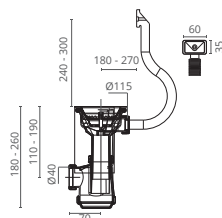

SIMPLES C/ VÁLVULA CESTO E AVISADOR

REF.	MODELO			€
BK2012040	SS-06*	5	30	10.75

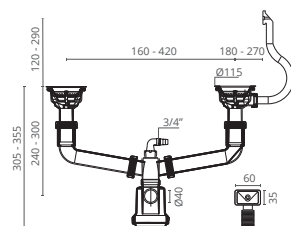

DUPLO C/ VÁLVULAS CESTO E AVISADOR

REF.	MODELO			€
BK2012240	SD-06*	5	14	20.55

* ARTIGO FORNECIDO EM SACO DE PLÁSTICO

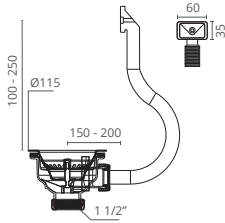

VÁLVULA C/ CESTO INOX E AVISADOR

REF.	MODELO			€
BK2013220	Ø115 VC-02*	5	30	8.70

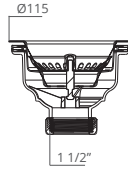

VÁLVULA C/ CESTO INOX

REF.	MODELO			€
BK2013210	Ø115 VC-01*	5	50	6.75

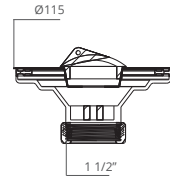

VÁLVULA SIMPLES

REF.	MODELO			€
BK2013200	Ø115 VS-01*	5	70	3.37

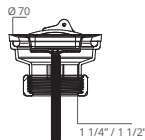

VÁLVULA LAVATÓRIO

REF.	MODELO			€
BK2013010	1 1/4\" VL-01	5	130	2.72
BK2013020	1 1/2\" VL-02	5	85	2.90



VÁLVULA ROSCADA

REF.	MODELO			€
BK2013030	1 1/4\" VL-03	5	100	1.85

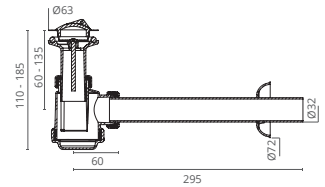

SIFÃO GARRAFA LAVATÓRIO

REF.	MODELO			€
BK2013000	1 1/4\" SL-01	1	30	4.65



CESTO INOX

REF.	MEDIDAS			€
BK2013290	Ø115	5	200	2.55



TACO 43 mm

REF.	COR			€
BK2013905	PRETO	10	650	0.30



TACO LAVATÓRIO 38 mm

REF.	COR			€
BK2013900	PRETO	10	1000	0.30

* ARTIGO FORNECIDO EM SACO DE PLÁSTICO

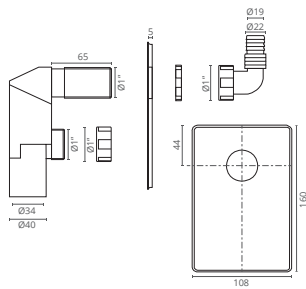

SIFÃO INTERIOR CROMADO

REF.	MEDIDAS			€
BK2004000	Ø40 x 18/24 mm	5	50	7,70



A B

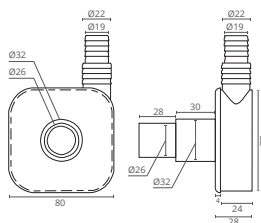

SIFÃO EXTERIOR

REF.	MEDIDAS	COR			€
A BK2004020	Ø32 X 26 mm		1	50	3,20
B BK2004021	Ø32 X 26 mm		1	50	6,00

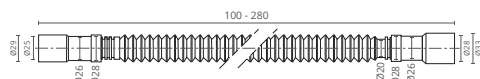

TUBO DESCARGA EXTENSÍVEL

REF.	MEDIDAS			€
BK2004100	1,00 - 2,8 m	1	100	1,98



TUBO DESCARGA

REF.	MEDIDAS			€
BK2004121	1,50 m	1	50	1,62
BK2004122	2,00 m	1	50	1,93
BK2004124	3,00 m	1	50	2,68

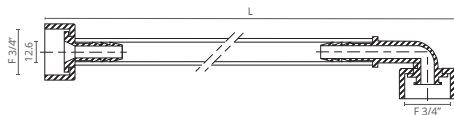

BICHAS CARGA

REF.	MEDIDAS			€
BK2004200	1,50 m	1	50	3,29
BK2004202	2,00 m	1	50	3,77
BK2004203	2,50 m	1	50	4,32

2 tampos de sanita

A Ctesi apresenta-lhe uma variada gama de tampos de sanita em diferentes estilos e materiais como o polipropileno, MDF ou duraplast.

Todos os nossos tampos são produzidos de acordo com os mais rigorosos testes de qualidade.

De fácil instalação, as ferragens utilizadas para estes tampos são de alta qualidade, permitindo uma simples instalação, mas também uma durabilidade comprovada.

As qualidades dos tampos de sanita Ctesi comprovam-se não apenas pelos seus materiais de primeira linha, mas também pela elegância e conforto que conferem à sua sanita.

Qualidade, desempenho e alta durabilidade são sinónimos de tampos de sanita Ctesi.





POLIPROPILENO

versátil
elevada resistência
e grande durabilidade

Polipropileno (PP) é um material muito versátil de elevada resistência química e a solventes, de fácil modelação e óptima resistência ao impacto enquanto garante uma grande durabilidade. Permite obter um óptimo compromisso entre a rigidez e a resistência ao impacto.

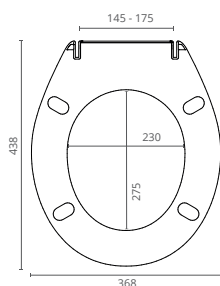
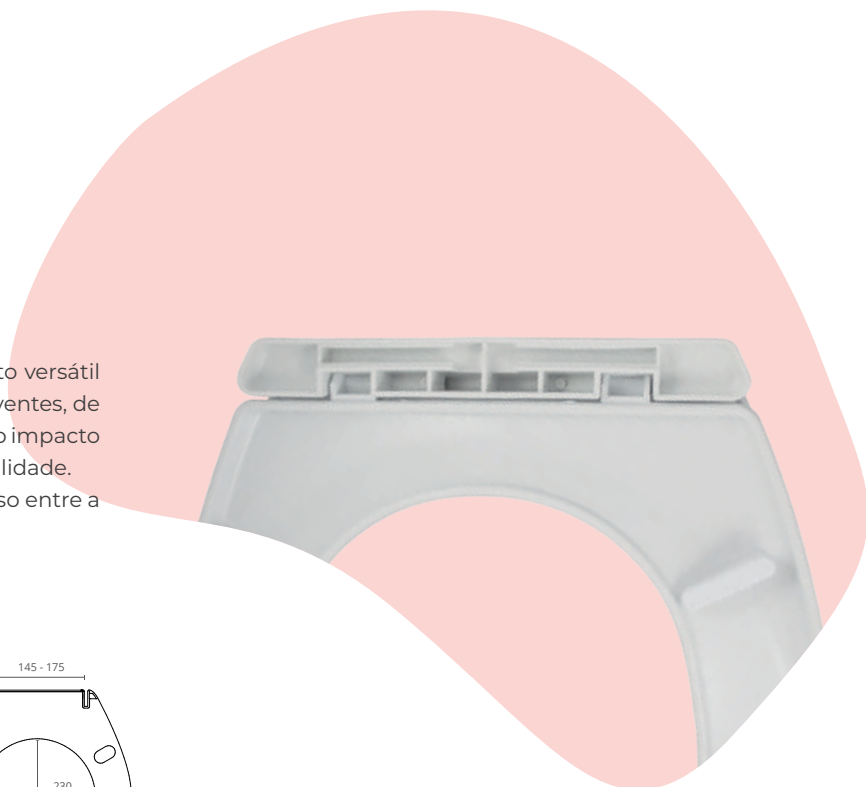

COMPATIBILIDADES:
EUROPA, MUNIQUE, ESTACO, MONTEROSA, NEOCLÁSSICA, LISBOA, ALGARVE, ALVOR

ÍLHAVO

REF.	COR			€
BK3000000	BRANCO	6	12	8.40

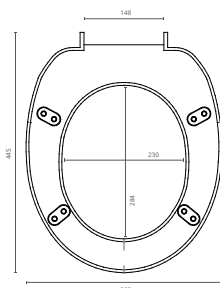

COMPATIBILIDADES:
APOLO, ALVOR, ITÁLIA, VITÓRIA, MONTEROSA, NEOCLÁSSICA, RUBI, IMPERIAL, ESTACO, MUNIQUE

EQUADOR

REF.	COR			€
BK3000020	BRANCO	5	10	12.50

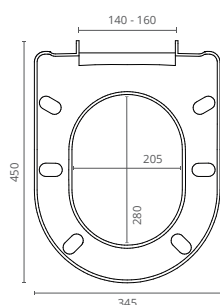

COMPATIBILIDADES:
ÁQUA, AVEIRO, CONDOR, DAMA, IMAGE, EDEN, MERIDIAN, PRESTIGE, REGINA, THEMA

LUGO

REF.	COR			€
BK3000040	BRANCO	5	10	15.00

DUROPLAST

muito resistente a abrasão e a químicos

É composto por material reciclado, desperdícios de algodão e resinas fenólicas, reforçado com fibras de algodão ou lã, tornando-se um plástico semelhante à fibra de vidro e com um aspecto idêntico ao da cerâmica.

Resistente a choques | Material antibacteriano | Facilidade de limpeza



U

COMPATIBILIDADES:

EUROPA, ITÁLIA, MUNIQUE, ESTACO, MADALENA, APOLO, NEOCLÁSSICA, MONTEROSA, LUNA, VITÓRIA, ALVOR, LISBOA, ALGARVE, RUBI

HERA

REF.	COR			€
BK3002060	BRANCO	1	10	22.20

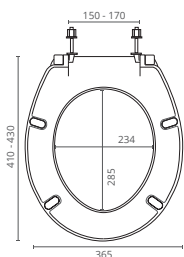

U

COMPATIBILIDADES:

ALFA, ALFA PLUS, OCEANUS, EROS

EDNA

REF.	COR			€
BK3002080	BRANCO	1	5	35.20

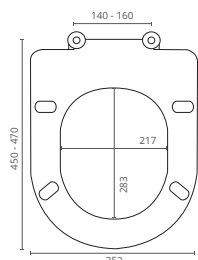

U

COMPATIBILIDADES:

REGINA, ATLANTA, STYLO, MERIDIAN, FLORENÇA, NEXO, AVEIRO, AQUA, CONDOR, IMAGE, MIMOSA, OCEANUS, PRESTIGE, DANUBIO, ESTORIL, PROJET, SIRIUS, URBYT

MUSA

REF.	COR			€
BK3002020	BRANCO	1	5	35.90

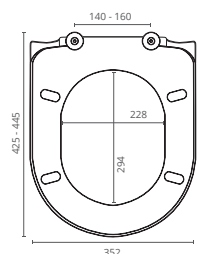

U

COMPATIBILIDADES:

INGLÉS, RUBI, ESTACO, ALGARVE, APOLO, CONCHA, CONCRETA, ITÁLIA, LUNAR, MUNIQUE, MUNIQUE PLUS, MONTEROSA, MADALENA, SUPERBUS, SACAÉM, VITÓRIA, POLO ZOOM, CETUS, EUROPA, HELIA, LISBOA

DÓRIS

REF.	COR			€
BK3002000	BRANCO	1	5	33.60

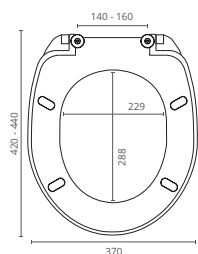

U

COMPATIBILIDADES:

ARIES, CONCORDE, CALYPSO, VENEZA, GÓNDOLA

ARIA

REF.	COR			€
BK3002040	BRANCO	1	5	32.20

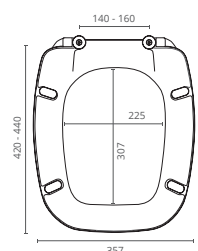

DUROPLAST SOFT-CLOSE

Os tampos de sanita **Leto**, **Memphis**, **Gap**, **Vitoria**, **Thin** e **Sublime** são construídos em Duroplast, um material de elevada resistência no qual se adicionam na sua construção partículas com propriedades anti-bacterianas, maximizando assim a limpeza e higiene em tampos de sanita que se apresentam com um aspecto brilhante ímpar.



FÁCIL INSTALAÇÃO

As ferragens que equipam esta gama de tampos de sanita destacam-se pela robustez e simplicidade de instalação. Aplique em primeiro lugar as ferragens sem a necessidade de ter o tampo acoplado e só após aplique facilmente o tampo sobre as ferragens que o fixam à sanita.



FÁCIL DESMONTAGEM PARA LIMPEZA

O novo sistema incorporado no tampo com botão de fácil pressão para retirar o tampo, facilita as operações de instalação e remoção para limpeza que pode ser feita facilmente por qualquer pessoa.



FECHO AMORTECIDO

O fecho amortecido "Soft Close" que equipa esta gama de tampos de sanita suaviza o fecho do tampo, conferindo desta forma um maior conforto e segurança no seu uso diário.

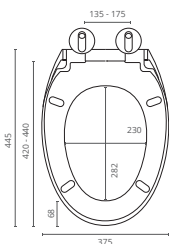

COMPATIBILIDADES:

INGLÊS, RUBI, ESTACO, ALGARVE, APOLO, CONCHA, CONCRETA, ITÁLIA, LUNAR, MUNIQUE, MUNIQUE PLUS, MONTEROSA, MADALENA, SUPERBUS, SACAIVÉM, VITÓRIA, POLO ZOOM, CETUS, EUROPA, HELIA, LISBOA

LETO

REF.	COR			€
BK3004020	BRANCO	1	5	42.50

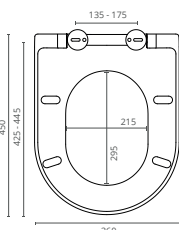

COMPATIBILIDADES:

STYLO, MERIDIAN, FLORENÇA, AVEIRO, AQUA, CONDOR, IMAGE, MIMOSA, OCEANUS, PRESTIGE, PROJET, EROS, SIRIUS, URBY, NEXO

MEMPHIS

REF.	COR			€
BK3004060	BRANCO	1	5	44.00

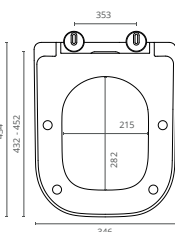

GAP

REF.	COR			€
BK3004050	BRANCO	1	5	44.00

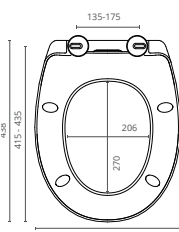

VITORIA

REF.	COR			€
BK3004030	BRANCO	1	5	42.50



DUROPLAST SLIM SOFT-CLOSE



RESISTÊNCIA CONCENTRADA

Os tampos de sanita Sublime e Thin são construídos em duroplast, um plástico de elevada resistência e solidez e que se apresenta no seu máximo esplendor devido à reduzida espessura de cada conjunto.

MÁXIMO CONFORTO E ELEGÂNCIA

Assim, concentramos em apenas 21 mm de espessura toda a resistência deste plástico reforçado com fibra e que termina com um acabamento brilhante e sublime. Com os tampos de sanita em Duroplast slim desfrute com o máximo conforto deste material antibacteriano num design de extrema elegância.

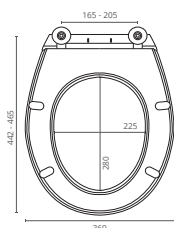

COMPATIBILIDADES:

INGLÊS, RUBI, ESTACO, ALGARVE, APOLO, CONCHA, CONCRETA, ITÁLIA, LUNAR, MUNIQUE, MUNIQUE PLUS, MONTEROSA, MADALENA, SUPERBUS, SACAVÉM, VITÓRIA, POLO ZOOM, CETUS, EUROPA, HELIA, LISBOA

SUBLIME

REF.	COR			€
BK3005000	BRANCO	1	5	52.50

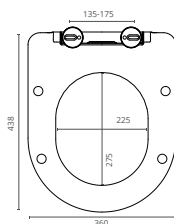

COMPATIBILIDADES:

REGINA, ATLANTA, STYLO, MERIDIAN, FLORENÇA, ALFA, ALFA PLUS, NEXO, AVEIRO, AQUA, CONDOR, DAMA, IMAGE, JADE, MIMOSA, OCEANUS, PRESTIGE, DANUBIO, ESTORIL, ELEGANCE, THEMA, PROJET, EROS, SIRIUS, URBY

THIN

REF.	COR			€
BK3005020	BRANCO	1	5	52.50

MDF OU CONTRAPLACADO MARÍTIMO

PERSONALIZAÇÃO

TAMPOS DE SANITA EM MDF OU CONTRAPLACADO MARÍTIMO

Os tampos de sanita em MDF ou Contraplacado Marítimo Ctesi® são fabricados à medida das suas necessidades e por isso adaptam-se a qualquer modelo de sanita. Oferecem-lhe uma sensação mais quente e proporcionam um estilo natural ao seu espaço de banho.

Além das clássicas tampas brancas, poderá encontrar uma vasta gama de modelos de diferentes cores e acabamentos, como por exemplo, os acabamentos em madeira natural como o Wenguê, a Cerejeira ou a madeira natural em tons de bege, castanho ou ainda os acabamentos Premium sobre contraplacado marítimo como a Cortiça, a folha de Ébano Natural ou Cracklé. Além disso, toda a carta de cores sólidas RAL® está disponível, pelo que o leque de cores disponíveis é infinito.

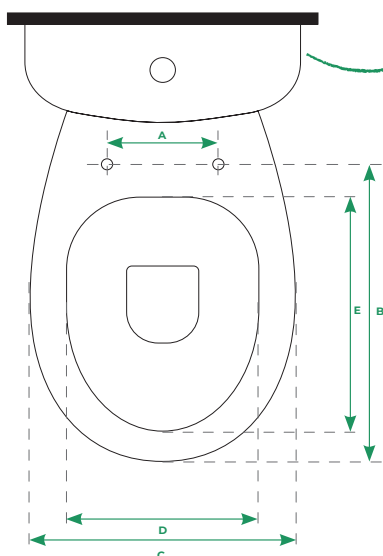

Se não sabe qual é o modelo exato da sua sanita, envie-nos uma foto e nós indicaremos qual o tampo adequado.

É importante que nos envie as **medidas da sanita** para que a tampa se adapte perfeitamente à sua casa de banho.

LEGENDA

- A - Distância entre os centros das furações da sanita
- B - Distância entre o centro das furações da sanita até à parte frontal da sanita
- C - Largura máxima da sanita
- D - Largura interior da sanita
- E - Profundidade interior da sanita

QUALQUER
MODELO

QUALQUER
MEDIDA

Obtenha o formulário para pedido de cotação e/ou encomenda, junto de um dos nossos parceiros ou directamente connosco para o e-mail: geral@barros-moreira.pt

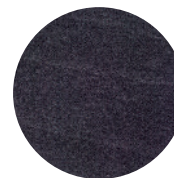
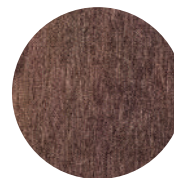

QUALQUER
COR
RAL®



MADEIRA NATURAL

A alta densidade da madeira torna-a adequada para um tampo de sanita enquanto a sensação quente ao toque lhe proporciona o conforto desejado.

Os tampos de sanita em MDF lacados ou em Contraplacado Marítimo com velatura são acabados com tinta ecológica, resultando num nobre acabamento. Na Ctesi®, usamos madeiras provenientes de florestas bem geridas e com elevados níveis de sustentabilidade, de acordo com as melhores práticas ambientais, económicas e sociais.

MDF UNIVERSAIS

MDF oferece um estilo mais natural à casa de banho

Um derivado da madeira e excelente substituto da mesma. Com um acabamento uniforme, não apresenta veios ou outras irregularidades da madeira. Com alta densidade, é resistente, estável, plano e permite distintos acabamentos do tipo lacado de alto brilho.

Resistente a choques | Material antibacteriano | Facilidade de limpeza

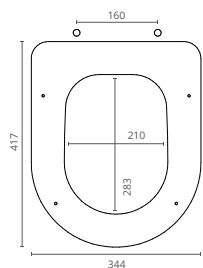

DOBRADIÇA



FIXAÇÃO

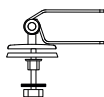

COMPATIBILIDADES:

ÁQUA, AVEIRO, CONDOR, ESTORIL, IMAGE, REGINA, THEMA, DANÚBIO, DELTA, ELEGANCE, OCEANUS, FLORENÇA, JADE

VÊNUS

REF.	COR			€
BK3018000	BRANCO	1	5	50.00

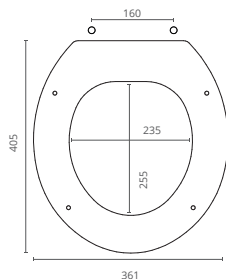

DOBRADIÇA



FIXAÇÃO

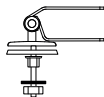

COMPATIBILIDADES:

EUROPA, ITÁLIA, MUNIQUE, ESTACO, MADALENA, APOLO, NEOCLÁSSICA, MONTEROSA, LUNA, VITÓRIA, ALVOR, LISBOA, ALGARVE, RUBI

AFRODITE

REF.	COR			€
BK3018600	BRANCO	1	5	50.00

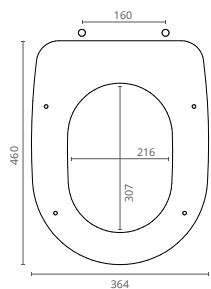

DOBRADIÇA



FIXAÇÃO

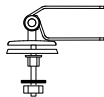

COMPATIBILIDADES:

ALFA, DAMA, MERIDIAN, PRESTIGE

ZEUS

REF.	COR			€
BK3018200	BRANCO	1	5	50.00

MDF

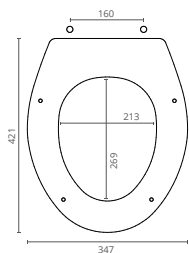

SOFT-CLOSE:

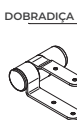

EUROPA

SEM SOFT-CLOSE		COM SOFT-CLOSE		COR		
REF.	€	REF.	€			
BK3010000	50.00	BK3010005	70.00	BRANCO	1	5
BK3010010	57.50	BK3010015	77.50	PERGAMON	1	5
BK3010020	67.50	BK3010025	87.50	ROSA PÉROLA	1	5
BK3010030	67.50	BK3010035	87.50	CINZA	1	5
BK3010040	67.50	BK3010045	87.50	BEGE BAHAMA	1	5
BK3010050	67.50	BK3010055	87.50	PÉROLA	1	5
BK3010060	90.00	BK3010065	110.00	RAL*	-	5

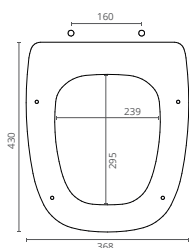

SOFT-CLOSE:

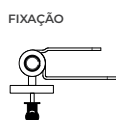

VENEZA

SEM SOFT-CLOSE		COM SOFT-CLOSE		COR		
REF.	€	REF.	€			
BK3010200	50.00	BK3010205	70.00	BRANCO	1	5
BK3010210	57.50	BK3010215	77.50	PERGAMON	1	5
BK3010220	67.50	BK3010225	87.50	ROSA PÉROLA	1	5
BK3010230	67.50	BK3010235	87.50	CINZA	1	5
BK3010240	67.50	BK3010245	87.50	BEGE BAHAMA	1	5
BK3010250	67.50	BK3010255	87.50	PÉROLA	1	5
BK3010260	90.00	BK3010265	110.00	RAL*	-	5

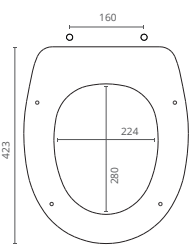

SOFT-CLOSE:



MUNIQUE

SEM SOFT-CLOSE		COM SOFT-CLOSE		COR		
REF.	€	REF.	€			
BK3010400	50.00	BK3010405	70.00	BRANCO	1	5
BK3010410	57.50	BK3010415	77.50	PERGAMON	1	5
BK3010420	67.50	BK3010425	87.50	ROSA PÉROLA	1	5
BK3010430	67.50	BK3010435	87.50	CINZA	1	5
BK3010440	67.50	BK3010445	87.50	BEGE BAHAMA	1	5
BK3010450	67.50	BK3010455	87.50	PÉROLA	1	5
BK3010460	90.00	BK3010465	110.00	RAL*	-	5

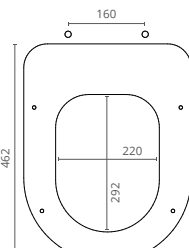

SOFT-CLOSE:

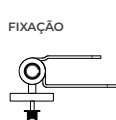

ALFA

SEM SOFT-CLOSE		COM SOFT-CLOSE		COR		
REF.	€	REF.	€			
BK3010600	50.00	BK3010605	70.00	BRANCO	1	5
BK3010610	57.50	BK3010615	77.50	PERGAMON	1	5
BK3010620	67.50	BK3010625	87.50	ROSA PÉROLA	1	5
BK3010630	67.50	BK3010635	87.50	CINZA	1	5
BK3010640	67.50	BK3010645	87.50	BEGE BAHAMA	1	5
BK3010650	67.50	BK3010655	87.50	PÉROLA	1	5
BK3010660	90.00	BK3010665	110.00	RAL*	-	5

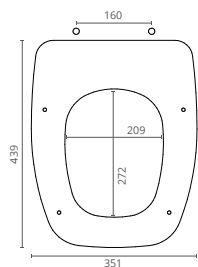

DOBRADIÇA FIXAÇÃO



SOFT-CLOSE:

DOBRADIÇA FIXAÇÃO

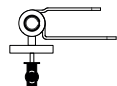

CONCORDE

SEM SOFT-CLOSE		COM SOFT-CLOSE		COR		
REF.	€	REF.	€			
BK3010800	50.00	BK3010805	70.00	BRANCO		1 5
BK3010810	57.50	BK3010815	77.50	PERGAMON		1 5
BK3010820	67.50	BK3010825	87.50	ROSA PÉROLA		1 5
BK3010830	67.50	BK3010835	87.50	CINZA		1 5
BK3010840	67.50	BK3010845	87.50	BEGE BAHAMA		1 5
BK3010850	67.50	BK3010855	87.50	PÉROLA		1 5
BK3010860	90.00	BK3010865	110.00	RAL®	-	1 5

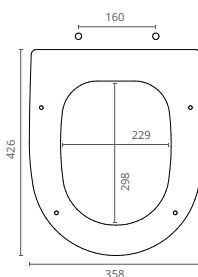

DOBRADIÇA FIXAÇÃO



SOFT-CLOSE:

DOBRADIÇA FIXAÇÃO

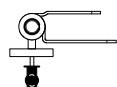

AVEIRO

SEM SOFT-CLOSE		COM SOFT-CLOSE		COR		
REF.	€	REF.	€			
BK3011000	50.00	BK3011005	70.00	BRANCO		1 5
BK3011010	57.50	BK3011015	77.50	PERGAMON		1 5
BK3011020	67.50	BK3011025	87.50	ROSA PÉROLA		1 5
BK3011030	67.50	BK3011035	87.50	CINZA		1 5
BK3011040	67.50	BK3011045	87.50	BEGE BAHAMA		1 5
BK3011050	67.50	BK3011055	87.50	PÉROLA		1 5
BK3011060	90.00	BK3011065	110.00	RAL®	-	1 5

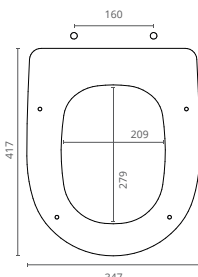

DOBRADIÇA FIXAÇÃO



SOFT-CLOSE:

DOBRADIÇA FIXAÇÃO

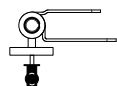

REGINA

SEM SOFT-CLOSE		COM SOFT-CLOSE		COR		
REF.	€	REF.	€			
BK3011200	50.00	BK3011205	70.00	BRANCO		1 5
BK3011210	57.50	BK3011215	77.50	PERGAMON		1 5
BK3011220	67.50	BK3011225	87.50	ROSA PÉROLA		1 5
BK3011230	67.50	BK3011235	87.50	CINZA		1 5
BK3011240	67.50	BK3011245	87.50	BEGE BAHAMA		1 5
BK3011250	67.50	BK3011255	87.50	PÉROLA		1 5
BK3011260	90.00	BK3011265	110.00	RAL®	-	1 5

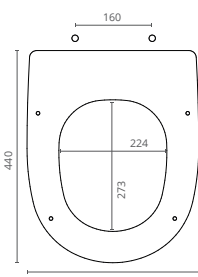

DOBRADIÇA FIXAÇÃO



SOFT-CLOSE:

DOBRADIÇA FIXAÇÃO

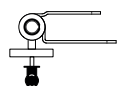

ESTORIL

SEM SOFT-CLOSE		COM SOFT-CLOSE		COR		
REF.	€	REF.	€			
BK3011400	50.00	BK3011405	70.00	BRANCO		1 5
BK3011410	57.50	BK3011415	77.50	PERGAMON		1 5
BK3011420	67.50	BK3011425	87.50	ROSA PÉROLA		1 5
BK3011430	67.50	BK3011435	87.50	CINZA		1 5
BK3011440	67.50	BK3011445	87.50	BEGE BAHAMA		1 5
BK3011450	67.50	BK3011455	87.50	PÉROLA		1 5
BK3011460	90.00	BK3011465	110.00	RAL®	-	1 5

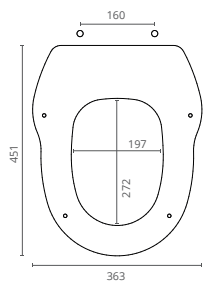

DOBRADIÇA FIXAÇÃO

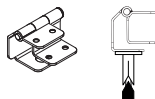

SOFT-CLOSE:

DOBRADIÇA FIXAÇÃO

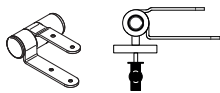

GRÉCIA

SEM SOFT-CLOSE		COM SOFT-CLOSE		COR		
REF.	€	REF.	€			
BK3011600	50.00	BK3011605	70.00	BRANCO	1	5
BK3011610	57.50	BK3011615	77.50	PERGAMON	1	5
BK3011620	67.50	BK3011625	87.50	ROSA PÉROLA	1	5
BK3011630	67.50	BK3011635	87.50	CINZA	1	5
BK3011640	67.50	BK3011645	87.50	BEGE BAHAMA	1	5
BK3011650	67.50	BK3011655	87.50	PÉROLA	1	5
BK3011660	90.00	BK3011665	110.00	RAL*	-	5

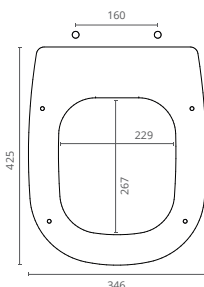

DOBRADIÇA FIXAÇÃO

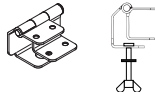

SOFT-CLOSE:

DOBRADIÇA FIXAÇÃO

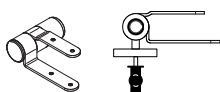

EDEN

SEM SOFT-CLOSE		COM SOFT-CLOSE		COR		
REF.	€	REF.	€			
BK3011800	50.00	BK3011805	70.00	BRANCO	1	5
BK3011810	57.50	BK3011815	77.50	PERGAMON	1	5
BK3011820	67.50	BK3011825	87.50	ROSA PÉROLA	1	5
BK3011830	67.50	BK3011835	87.50	CINZA	1	5
BK3011840	67.50	BK3011845	87.50	BEGE BAHAMA	1	5
BK3011850	67.50	BK3011855	87.50	PÉROLA	1	5
BK3011860	90.00	BK3011865	110.00	RAL*	-	5

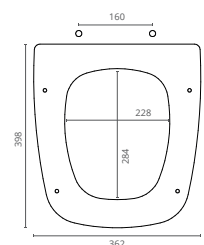

DOBRADIÇA FIXAÇÃO

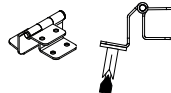

COLÓNIA

SEM SOFT-CLOSE		COR		
REF.	€			
BK3012400	50.00	BRANCO	1	5
BK3012410	57.50	PERGAMON	1	5
BK3012420	67.50	ROSA PÉROLA	1	5
BK3012430	67.50	CINZA	1	5
BK3012440	67.50	BEGE BAHAMA	1	5
BK3012450	67.50	PÉROLA	1	5
BK3012460	90.00	RAL*	-	5

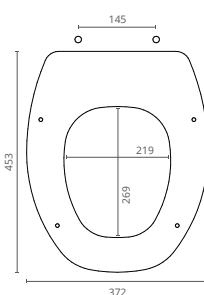

DOBRADIÇA FIXAÇÃO

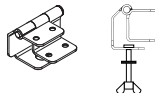

SOFT-CLOSE:

DOBRADIÇA FIXAÇÃO

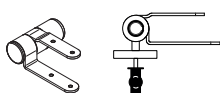

MONTEBIANCO

SEM SOFT-CLOSE		COM SOFT-CLOSE		COR		
REF.	€	REF.	€			
BK3012200	50.00	BK3012205	70.00	BRANCO	1	5
BK3012210	57.50	BK3012215	77.50	PERGAMON	1	5
BK3012220	67.50	BK3012225	87.50	ROSA PÉROLA	1	5
BK3012230	67.50	BK3012235	87.50	CINZA	1	5
BK3012240	67.50	BK3012245	87.50	BEGE BAHAMA	1	5
BK3012250	67.50	BK3012255	87.50	PÉROLA	1	5
BK3012260	90.00	BK3012265	110.00	RAL*	-	5

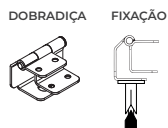
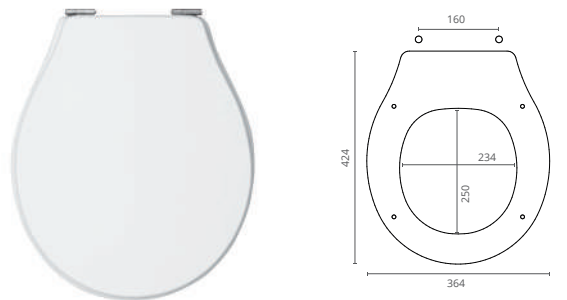

SOFT-CLOSE:

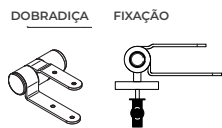

NEOCLÁSSICA

SEM SOFT-CLOSE		COM SOFT-CLOSE		COR	🗑️	🚰
REF.	€	REF.	€			
BK3012600	50.00	BK3012605	70.00	BRANCO	1	5
BK3012610	57.50	BK3012615	77.50	PERGAMON	1	5
BK3012620	67.50	BK3012625	87.50	ROSA PÉROLA	1	5
BK3012630	67.50	BK3012635	87.50	CINZA	1	5
BK3012640	67.50	BK3012645	87.50	BEGE BAHAMA	1	5
BK3012650	67.50	BK3012655	87.50	PÉROLA	1	5
BK3012660	90.00	BK3012665	110.00	RAL®	-	5

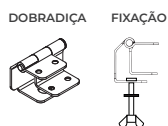
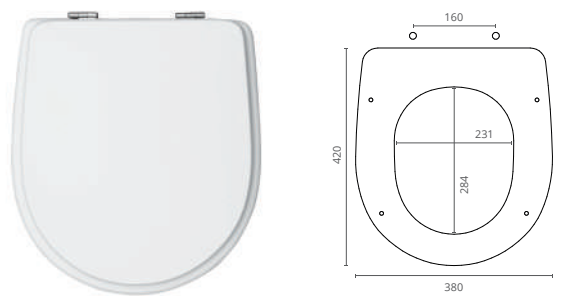

SOFT-CLOSE:

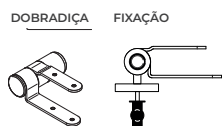

IMAGE

SEM SOFT-CLOSE		COM SOFT-CLOSE		COR	🗑️	🚰
REF.	€	REF.	€			
BK3012000	50.00	BK3012005	70.00	BRANCO	1	5
BK3012010	57.50	BK3012015	77.50	PERGAMON	1	5
BK3012020	67.50	BK3012025	87.50	ROSA PÉROLA	1	5
BK3012030	67.50	BK3012035	87.50	CINZA	1	5
BK3012040	67.50	BK3012045	87.50	BEGE BAHAMA	1	5
BK3012050	67.50	BK3012055	87.50	PÉROLA	1	5
BK3012060	90.00	BK3012065	110.00	RAL®	-	5

TABELA DE PREÇOS GERAL PARA TAMPÓS DE SANITA EM MDF

MDF LACADO

TAMPO DE SANITA	DOBRADIÇA NORMAL				DOBRADIÇA SOFT-CLOSE			
	BRANCO	PERGAMON	CORES	RAL®	BRANCO	PERGAMON	CORES	RAL®
SEM TRASEIRA MODELOS À MEDIDA	55.00€	62.50€	72.50€	95.00€	75.00€	82.50€	92.50€	115.00€
COM TRASEIRA MODELOS À MEDIDA	60.00€	67.50€	77.50€	100.00€	-	-	-	-
SANITA UP* MODELOS À MEDIDA	60.00€	67.50€	77.50€	100.00€	80.00€	90.00€	100.00€	120.00€
PESSOAS MOBILIDADE REDUZIDA	57.50€	65.00€	75.00€	97.50€	77.50€	85.00€	95.00€	117.50€
INFANTIL SEM TRASEIRA	55.00€	62.50€	72.50€	95.00€	75.00€	82.50€	92.50€	115.00€
INFANTIL COM TRASEIRA	62.50€	70.00€	80.00€	105.00€	-	-	-	-

* Os modelos Up caracterizam-se por o perímetro do aro e do tampo de sanita serem exatamente iguais, com corte reto, contrariamente aos tradicionais em que a tendência é a do aro ser ligeiramente superior à tampa e ambos com orla boleada.

CONTRAPLACADO MARÍTIMO

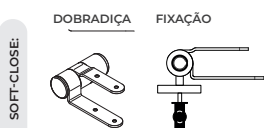
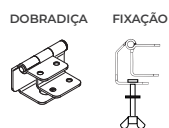
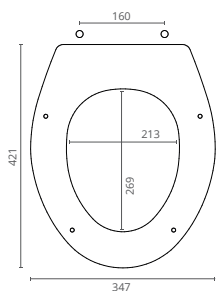

EUROPA

SEM SOFT-CLOSE		COM SOFT-CLOSE		COR LACADA OU MADEIRA			
REF.	€	REF.	€				
BK3020000	62.50	BK3020005	82.50	BRANCO	1	5	
BK3020010	70.00	BK3020015	90.00	PERGAMON	1	5	
BK3020020	80.00	BK3020025	100.00	ROSA PÉROLA	1	5	
BK3020030	80.00	BK3020035	100.00	CINZA	1	5	
BK3020040	80.00	BK3020045	100.00	BEGE BAHAMA	1	5	
BK3020050	80.00	BK3020055	100.00	PÉROLA	1	5	
BK3020060	102.50	BK3020065	122.50	RAL*	-	1	5
BK3020100	80.00	BK3020105	100.00	BEGE - VELATURA	1	5	
BK3020110	80.00	BK3020115	100.00	WENGUE - VELATURA	1	5	
BK3020120	80.00	BK3020125	100.00	CASTANHO - VELATURA	1	5	
BK3020130	80.00	BK3020135	100.00	CEREJEIRA - VELATURA	1	5	
BK3020140	80.00	BK3020145	100.00	FAIA - VELATURA	1	5	

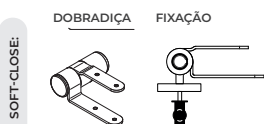
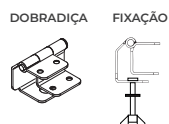
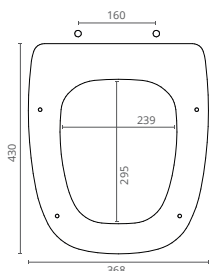

ENEZA

SEM SOFT-CLOSE		COM SOFT-CLOSE		COR LACADA OU MADEIRA			
REF.	€	REF.	€				
BK3020200	62.50	BK3020205	82.50	BRANCO	1	5	
BK3020210	70.00	BK3020215	90.00	PERGAMON	1	5	
BK3020220	80.00	BK3020225	100.00	ROSA PÉROLA	1	5	
BK3020230	80.00	BK3020235	100.00	CINZA	1	5	
BK3020240	80.00	BK3020245	100.00	BEGE BAHAMA	1	5	
BK3020250	80.00	BK3020255	100.00	PÉROLA	1	5	
BK3020260	102.50	BK3020265	122.50	RAL*	-	1	5
BK3020300	80.00	BK3020305	100.00	BEGE - VELATURA	1	5	
BK3020310	80.00	BK3020315	100.00	WENGUE - VELATURA	1	5	
BK3020320	80.00	BK3020325	100.00	CASTANHO - VELATURA	1	5	
BK3020330	80.00	BK3020335	100.00	CEREJEIRA - VELATURA	1	5	
BK3020340	80.00	BK3020345	100.00	FAIA - VELATURA	1	5	

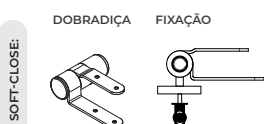
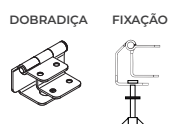
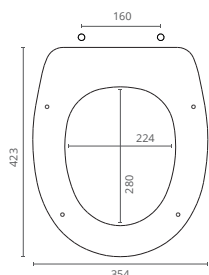

MUNIQUE

SEM SOFT-CLOSE		COM SOFT-CLOSE		COR LACADA OU MADEIRA			
REF.	€	REF.	€				
BK3020400	62.50	BK3020405	82.50	BRANCO	1	5	
BK3020410	70.00	BK3020415	90.00	PERGAMON	1	5	
BK3020420	80.00	BK3020425	100.00	ROSA PÉROLA	1	5	
BK3020430	80.00	BK3020435	100.00	CINZA	1	5	
BK3020440	80.00	BK3020445	100.00	BEGE BAHAMA	1	5	
BK3020450	80.00	BK3020455	100.00	PÉROLA	1	5	
BK3020460	102.50	BK3020465	122.50	RAL*	-	1	5
BK3020500	80.00	BK3020505	100.00	BEGE - VELATURA	1	5	
BK3020510	80.00	BK3020515	100.00	WENGUE - VELATURA	1	5	
BK3020520	80.00	BK3020525	100.00	CASTANHO - VELATURA	1	5	
BK3020530	80.00	BK3020535	100.00	CEREJEIRA - VELATURA	1	5	
BK3020540	80.00	BK3020545	100.00	FAIA - VELATURA	1	5	

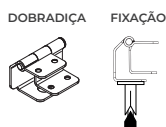
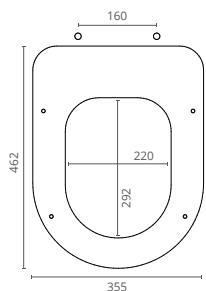

SOFT-CLOSE:

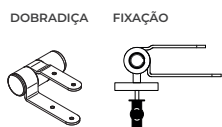

ALFA

SEM SOFT-CLOSE		COM SOFT-CLOSE		COR LACADA OU MADEIRA		
REF.	€	REF.	€			
BK3020600	62.50	BK3020605	82.50	BRANCO	1	5
BK3020610	70.00	BK3020615	90.00	PERGAMON	1	5
BK3020620	80.00	BK3020625	100.00	ROSA PÉROLA	1	5
BK3020630	80.00	BK3020635	100.00	CINZA	1	5
BK3020640	80.00	BK3020645	100.00	BEGE BAHAMA	1	5
BK3020650	80.00	BK3020655	100.00	PÉROLA	1	5
BK3020660	102.50	BK3020665	122.50	RAL*	-	1 5
BK3020700	80.00	BK3020705	100.00	BEGE - VELATURA	1	5
BK3020710	80.00	BK3020715	100.00	WENGUÉ - VELATURA	1	5
BK3020720	80.00	BK3020725	100.00	CASTANHO - VELATURA	1	5
BK3020730	80.00	BK3020735	100.00	CEREJEIRA - VELATURA	1	5
BK3020740	80.00	BK3020745	100.00	FAIA - VELATURA	1	5

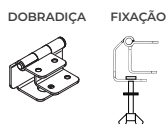
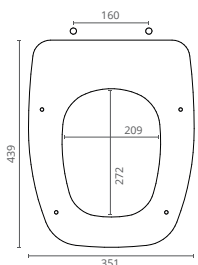

SOFT-CLOSE:

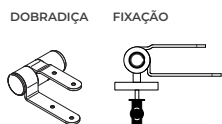

CONCORDE

SEM SOFT-CLOSE		COM SOFT-CLOSE		COR LACADA OU MADEIRA		
REF.	€	REF.	€			
BK3020800	62.50	BK3020805	82.50	BRANCO	1	5
BK3020810	70.00	BK3020815	90.00	PERGAMON	1	5
BK3020820	80.00	BK3020825	100.00	ROSA PÉROLA	1	5
BK3020830	80.00	BK3020835	100.00	CINZA	1	5
BK3020840	80.00	BK3020845	100.00	BEGE BAHAMA	1	5
BK3020850	80.00	BK3020855	100.00	PÉROLA	1	5
BK3020860	102.50	BK3020865	122.50	RAL*	-	1 5
BK3020900	80.00	BK3020905	100.00	BEGE - VELATURA	1	5
BK3020910	80.00	BK3020915	100.00	WENGUÉ - VELATURA	1	5
BK3020920	80.00	BK3020925	100.00	CASTANHO - VELATURA	1	5
BK3020930	80.00	BK3020935	100.00	CEREJEIRA - VELATURA	1	5
BK3020940	80.00	BK3020945	100.00	FAIA - VELATURA	1	5

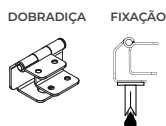
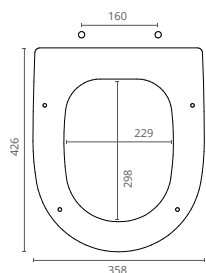

SOFT-CLOSE:

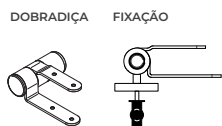

AVEIRO

SEM SOFT-CLOSE		COM SOFT-CLOSE		COR LACADA OU MADEIRA		
REF.	€	REF.	€			
BK3021000	62.50	BK3021005	82.50	BRANCO	1	5
BK3021010	70.00	BK3021015	90.00	PERGAMON	1	5
BK3021020	80.00	BK3021025	100.00	ROSA PÉROLA	1	5
BK3021030	80.00	BK3021035	100.00	CINZA	1	5
BK3021040	80.00	BK3021045	100.00	BEGE BAHAMA	1	5
BK3021050	80.00	BK3021055	100.00	PÉROLA	1	5
BK3021060	102.50	BK3021065	122.50	RAL*	-	1 5
BK3021100	80.00	BK3021105	100.00	BEGE - VELATURA	1	5
BK3021110	80.00	BK3021115	100.00	WENGUÉ - VELATURA	1	5
BK3021120	80.00	BK3021125	100.00	CASTANHO - VELATURA	1	5
BK3021130	80.00	BK3021135	100.00	CEREJEIRA - VELATURA	1	5
BK3021140	80.00	BK3021145	100.00	FAIA - VELATURA	1	5

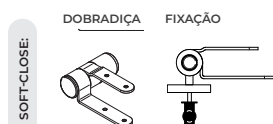
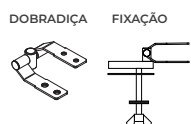
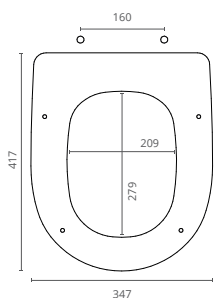

REGINA

SEM SOFT-CLOSE		COM SOFT-CLOSE		COR LACADA OU MADEIRA			
REF.	€	REF.	€				
BK3021200	62.50	BK3021205	82.50	BRANCO	1	5	
BK3021210	70.00	BK3021215	90.00	PERGAMON	1	5	
BK3021220	80.00	BK3021225	100.00	ROSA PÉROLA	1	5	
BK3021230	80.00	BK3021235	100.00	CINZA	1	5	
BK3021240	80.00	BK3021245	100.00	BEGE BAHAMA	1	5	
BK3021250	80.00	BK3021255	100.00	PÉROLA	1	5	
BK3021260	102.50	BK3021265	122.50	RAL*	-	1	5
BK3021300	80.00	BK3021305	100.00	BEGE - VELATURA	1	5	
BK3021310	80.00	BK3021315	100.00	WENGUÊ - VELATURA	1	5	
BK3021320	80.00	BK3021325	100.00	CASTANHO - VELATURA	1	5	
BK3021330	80.00	BK3021335	100.00	CEREJEIRA - VELATURA	1	5	
BK3021340	80.00	BK3021345	100.00	FAIA - VELATURA	1	5	

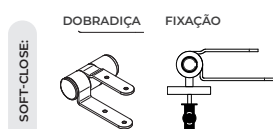
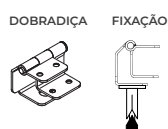
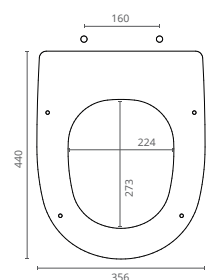

ESTORIL

SEM SOFT-CLOSE		COM SOFT-CLOSE		COR LACADA OU MADEIRA			
REF.	€	REF.	€				
BK3021400	62.50	BK3021405	82.50	BRANCO	1	5	
BK3021410	70.00	BK3021415	90.00	PERGAMON	1	5	
BK3021420	80.00	BK3021425	100.00	ROSA PÉROLA	1	5	
BK3021430	80.00	BK3021435	100.00	CINZA	1	5	
BK3021440	80.00	BK3021445	100.00	BEGE BAHAMA	1	5	
BK3021450	80.00	BK3021455	100.00	PÉROLA	1	5	
BK3021460	102.50	BK3021465	122.50	RAL*	-	1	5
BK3021500	80.00	BK3021505	100.00	BEGE - VELATURA	1	5	
BK3021510	80.00	BK3021515	100.00	WENGUÊ - VELATURA	1	5	
BK3021520	80.00	BK3021525	100.00	CASTANHO - VELATURA	1	5	
BK3021530	80.00	BK3021535	100.00	CEREJEIRA - VELATURA	1	5	
BK3021540	80.00	BK3021545	100.00	FAIA - VELATURA	1	5	

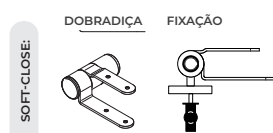
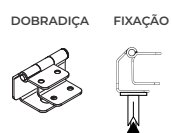
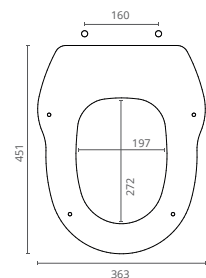

GRÉCIA

SEM SOFT-CLOSE		COM SOFT-CLOSE		COR LACADA OU MADEIRA			
REF.	€	REF.	€				
BK3021600	62.50	BK3021605	82.50	BRANCO	1	5	
BK3021610	70.00	BK3021615	90.00	PERGAMON	1	5	
BK3021620	80.00	BK3021625	100.00	ROSA PÉROLA	1	5	
BK3021630	80.00	BK3021635	100.00	CINZA	1	5	
BK3021640	80.00	BK3021645	100.00	BEGE BAHAMA	1	5	
BK3021650	80.00	BK3021655	100.00	PÉROLA	1	5	
BK3021660	102.50	BK3021665	122.50	RAL*	-	1	5
BK3021700	80.00	BK3021705	100.00	BEGE - VELATURA	1	5	
BK3021710	80.00	BK3021715	100.00	WENGUÊ - VELATURA	1	5	
BK3021720	80.00	BK3021725	100.00	CASTANHO - VELATURA	1	5	
BK3021730	80.00	BK3021735	100.00	CEREJEIRA - VELATURA	1	5	
BK3021740	80.00	BK3021745	100.00	FAIA - VELATURA	1	5	

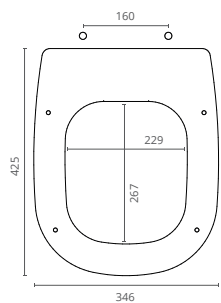

DOBRADIÇA FIXAÇÃO

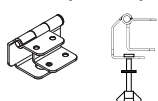

SOFT-CLOSE:

DOBRADIÇA FIXAÇÃO

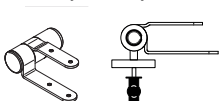

EDEN

SEM SOFT-CLOSE		COM SOFT-CLOSE		COR LACADA OU MADEIRA		
REF.	€	REF.	€			
BK3021800	62.50	BK3021805	82.50	BRANCO	1	5
BK3021810	70.00	BK3021815	90.00	PERGAMON	1	5
BK3021820	80.00	BK3021825	100.00	ROSA PÉROLA	1	5
BK3021830	80.00	BK3021835	100.00	CINZA	1	5
BK3021840	80.00	BK3021845	100.00	BEGE BAHAMA	1	5
BK3021850	80.00	BK3021855	100.00	PÉROLA	1	5
BK3021860	102.50	BK3021865	122.50	RAL®	-	1 5
BK3021900	80.00	BK3021905	100.00	BEGE - VELATURA	1	5
BK3021910	80.00	BK3021915	100.00	WENGUÉ - VELATURA	1	5
BK3021920	80.00	BK3021925	100.00	CASTANHO - VELATURA	1	5
BK3021930	80.00	BK3021935	100.00	CEREJEIRA - VELATURA	1	5
BK3021940	80.00	BK3021945	100.00	FAIA - VELATURA	1	5

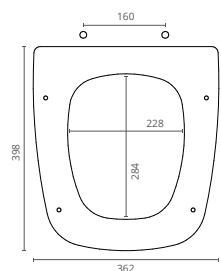

DOBRADIÇA FIXAÇÃO

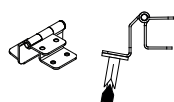

COLÓNIA

SEM SOFT-CLOSE		COR LACADA OU MADEIRA		
REF.	€			
BK3022400	62.50	BRANCO	1	5
BK3022410	70.00	PERGAMON	1	5
BK3022420	80.00	ROSA PÉROLA	1	5
BK3022430	80.00	CINZA	1	5
BK3022440	80.00	BEGE BAHAMA	1	5
BK3022450	80.00	PÉROLA	1	5
BK3022460	102.50	RAL®	-	1 5
BK3022500	80.00	BEGE - VELATURA	1	5
BK3022510	80.00	WENGUÉ - VELATURA	1	5
BK3022520	80.00	CASTANHO - VELATURA	1	5
BK3022530	80.00	CEREJEIRA - VELATURA	1	5
BK3022540	80.00	FAIA - VELATURA	1	5

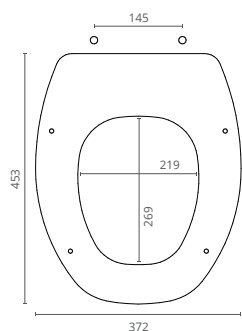

DOBRADIÇA FIXAÇÃO

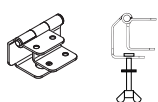

SOFT-CLOSE:

DOBRADIÇA FIXAÇÃO

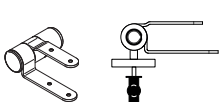

MONTEBIANCO

SEM SOFT-CLOSE		COM SOFT-CLOSE		COR LACADA OU MADEIRA		
REF.	€	REF.	€			
BK3022200	62.50	BK3022205	82.50	BRANCO	1	5
BK3022210	70.00	BK3022215	90.00	PERGAMON	1	5
BK3022220	80.00	BK3022225	100.00	ROSA PÉROLA	1	5
BK3022230	80.00	BK3022235	100.00	CINZA	1	5
BK3022240	80.00	BK3022245	100.00	BEGE BAHAMA	1	5
BK3022250	80.00	BK3022255	100.00	PÉROLA	1	5
BK3022260	102.50	BK3022265	122.50	RAL®	-	1 5
BK3022300	80.00	BK3022305	100.00	BEGE - VELATURA	1	5
BK3022310	80.00	BK3022315	100.00	WENGUÉ - VELATURA	1	5
BK3022320	80.00	BK3022325	100.00	CASTANHO - VELATURA	1	5
BK3022330	80.00	BK3022335	100.00	CEREJEIRA - VELATURA	1	5
BK3022340	80.00	BK3022345	100.00	FAIA - VELATURA	1	5

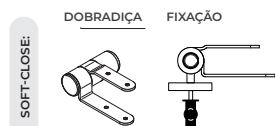
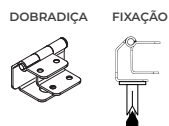
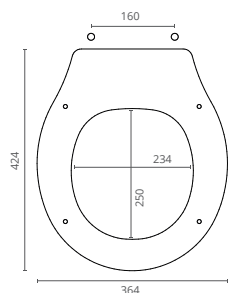

NEOCLÁSSICA

SEM SOFT-CLOSE		COM SOFT-CLOSE		COR LACADA OU MADEIRA	📦	📦
REF.	€	REF.	€			
BK3022600	62.50	BK3022605	82.50	BRANCO	1	5
BK3022610	70.00	BK3022615	90.00	PERGAMON	1	5
BK3022620	80.00	BK3022625	100.00	ROSA PÉROLA	1	5
BK3022630	80.00	BK3022635	100.00	CINZA	1	5
BK3022640	80.00	BK3022645	100.00	BEGE BAHAMA	1	5
BK3022650	80.00	BK3022655	100.00	PÉROLA	1	5
BK3022660	102.50	BK3022665	122.50	RAL*	-	1 5
BK3022700	80.00	BK3022705	100.00	BEGE - VELATURA	1	5
BK3022710	80.00	BK3022715	100.00	WENGUE - VELATURA	1	5
BK3022720	80.00	BK3022725	100.00	CASTANHO - VELATURA	1	5
BK3022730	80.00	BK3022735	100.00	CEREJEIRA - VELATURA	1	5
BK3022740	80.00	BK3022745	100.00	FAIA - VELATURA	1	5

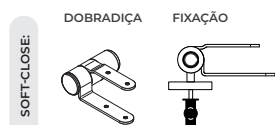
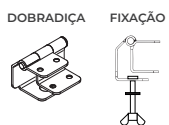
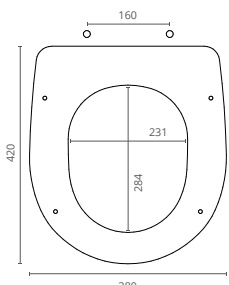

IMAGE

SEM SOFT-CLOSE		COM SOFT-CLOSE		COR LACADA OU MADEIRA	📦	📦
REF.	€	REF.	€			
BK3022000	62.50	BK3022005	82.50	BRANCO	1	5
BK3022010	70.00	BK3022015	90.00	PERGAMON	1	5
BK3022020	80.00	BK3022025	100.00	ROSA PÉROLA	1	5
BK3022030	80.00	BK3022035	100.00	CINZA	1	5
BK3022040	80.00	BK3022045	100.00	BEGE BAHAMA	1	5
BK3022050	80.00	BK3022055	100.00	PÉROLA	1	5
BK3022060	102.50	BK3022065	122.50	RAL*	-	1 5
BK3022100	80.00	BK3022105	100.00	BEGE - VELATURA	1	5
BK3022110	80.00	BK3022115	100.00	WENGUE - VELATURA	1	5
BK3022120	80.00	BK3022125	100.00	CASTANHO - VELATURA	1	5
BK3022130	80.00	BK3022135	100.00	CEREJEIRA - VELATURA	1	5
BK3022140	80.00	BK3022145	100.00	FAIA - VELATURA	1	5

TABELA DE PREÇOS GERAL PARA TAMPOS DE SANITA EM CONTRAPLACADO MARÍTIMO

CONTRAPLACADO MARÍTIMO LACADO

TAMPO DE SANITA	DOBRADIÇA NORMAL					DOBRADIÇA SOFT-CLOSE				
	BRANCO	PERGAMON	CORES	ENVERNIZADO	RAL®	BRANCO	PERGAMON	CORES	ENVERNIZADO	RAL®
SEM TRASEIRA MODELOS À MEDIDA	70.00€	77.50€	87.50€	87.50€	110.00€	87.50€	95.00€	105.00€	105.00€	127.50€
COM TRASEIRA MODELOS À MEDIDA	72.50€	80.00€	90.00€	90.00€	112.50€	-	-	-	-	-
SANITA UP* MODELOS À MEDIDA	72.50€	80.00€	90.00€	90.00€	112.50€	90.00€	97.50€	107.50€	107.50€	130.00€
PESSOAS MOBILIDADE REDUZIDA	72.50€	80.00€	90.00€	90.00€	112.50€	92.50€	100.00€	110.00€	110.00€	132.50€
INFANTIL SEM TRASEIRA	67.50€	75.00€	85.00€	85.00€	107.50€	87.50€	95.00€	105.00€	105.00€	127.50€
INFANTIL COM TRASEIRA	72.50€	80.00€	90.00€	90.00€	112.50€	-	-	-	-	-

* Os modelos Up caracterizam-se por o perímetro do aro e do tampo de sanita serem exatamente iguais, com corte reto, contrariamente aos tradicionais em que a tendência é a do aro ser ligeiramente superior à tampa e ambos com orla boleada.

POLIPROPILENO



ILHAVO

REF.		€
BK3090000	1	2.60



EQUADOR / LUGO

REF.		€
BK3090020	1	3.75

DUROPLAST



HERA

REF.		€
BK3090240	1	3.30



DÓRIS / ARIA

REF.		€
BK3090200	1	7.70



MUSA / EDNA

REF.		€
BK3090220	1	7.70



LETO / MEMPHIS / VITORIA / GAP / THIN / SUBLIME

REF.		€
BK3090260	1	15.20

MDF / CM



CONCORDE / IMAGE / VENEZA

REF.		€
BK3090310	1	9.50



REGINA

REF.		€
BK3090320	1	9.50



COLÓNIA

REF.		€
BK3090330	1	9.50



AFRODITE / VÉNUS / ZEUS

REF.		€
BK3090300	1	9.50



ALFA / ESTORIL

REF.		€
BK3090340	1	9.50

3 sistemas e acessórios

Elementos fundamentais para o bom funcionamento de qualquer casa de banho, os acessórios e sistemas de marca Ctesi são concebidos de modo a garantir durabilidade e eficiência ao longo do tempo de vida da sua utilização.

Desde elementos simples como válvulas ou tampões, até aos perlatores economizadores, que permitem uma efetiva poupança de água.

Todos estes produtos são de excelente qualidade, garantindo uma fácil aplicação e uma longa durabilidade.

Aposte na qualidade dos produtos da sua casa de banho, aposte nos produtos da marca Ctesi.



CTESI GREEN



CERTIFICAÇÃO ACS



PRINCIPAIS CARACTERÍSTICAS DOS TUBOS MULTICAMADA:

SEGURANÇA

A camada de alumínio dos tubos multicamada é soldada a topo, o que proporciona maior resistência à pressão e a tensões quando o tubo é curvado / dobrado.

RESISTENCIA A ALTAS TEMPERATURAS

Pode ser usado em temperaturas de até 95°C e até 110°C por algumas horas.

RESISTÊNCIA A PRESSÕES ELEVADAS

A vida útil estimada dos tubos multicamada a temperaturas entre 0-95°C e pressões até 10 bar são 50 anos. A 20°C a tubulação pode suportar pressões de até 25 bar.



APLICAÇÕES

- Instalações hidráulicas (abastecimento de água quente e fria)
- Instalações de aquecimento com radiadores
- Piso radiante
- Instalações industriais (ar comprimido, transporte de fluidos tóxicos ou corrosivos, etc)

CARACTERÍSTICAS TÉRMICAS

CARACTERÍSTICA	VALOR	UNIDADE
TEMPERATURA MÁXIMA DE SERVIÇO	95	°C
TEMPERATURA MÁXIMA PONTUAL	110	°C
COEFICIENTE DE DILATAÇÃO LINEAR	0.025	mm/m
CONDUTIVIDADE TÉRMICA	0.40	W/m.K

RESISTÊNCIA À PRESSÃO

CARACTERÍSTICA	VALOR	UNIDADE
RESISTÊNCIA A PRESSÃO INTERNA 20°C, 1hW	> 40	Bar
RESISTÊNCIA A PRESSÃO INTERNA 95°C, 1h	> 30	Bar
RESISTÊNCIA A PRESSÃO INTERNA 95°C, 165 h	> 16	Bar

CLASSES CONFORME ISO 21003

CARACTERÍSTICA	VALOR	UNIDADE
ÁGUA FRIA (20°C)	10	Bar
CLASSE 1. ABASTECIMENTO DE ÁGUA QUENTE A 60°C	6	Bar
CLASSE 1. ABASTECIMENTO DE ÁGUA QUENTE A 70°C	6	Bar
CLASSE 4. PISO RADIANTE	6	Bar
CLASSE 5. RADIADORES DE ALTA TEMPERATURA	6	Bar



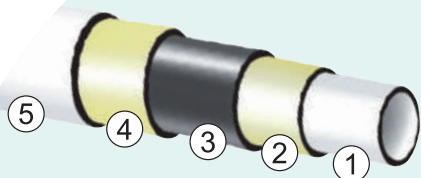

- ① 1ª Camada (interior): Tubo PEX-B. Polietileno Reticulado resistente a altas temperaturas, de acordo com a UNE-EN ISO 21003
- ② 2ª Camada: Adesivo especial para colar plástico e metal, com ponto de fusão superior a 120°C
- ③ 3ª Camada (central): Folha de alumínio soldada longitudinalmente por processo de ultra-sons
- ④ 4ª Camada: Adesivo especial para colar plástico e metal, com ponto de fusão superior a 120°C
- ⑤ 5ª Camada (exterior): Tubo PE. Polietileno resistente a altas temperaturas, de acordo com a UNE-EN ISO 21003

A tecnologia de fabricação dos tubos multicamada garante perfeita soldagem do alumínio, além de boa aderência entre plástico e metal, obtendo assim uma alta qualidade dos tubos, que atende perfeitamente aos requisitos do mercado.



UNE-EN ISO 21003
001/007094

TUBO PEX / AL / PE

REF.	MEDIDAS		PALETE	€/m
4020000	ROLO TUBO PEX/AL/PE 16 x 2.0 mm	100 m	2600 m	1.25
4020002	ROLO TUBO PEX/AL/PE 20 x 2.0 mm	100 m	1500 m	1.72
4020003	ROLO TUBO PEX/AL/PE 25 x 2.5 mm	50 m	700 m	2.68
4020004	ROLO TUBO PEX/AL/PE 32 x 3.0 mm	50 m	550 m	4.15

ACESSÓRIOS MULTICAMADA

Os acessórios multicamada da Ctesi encontram-se em conformidade com as normativas europeias, excluindo o níquel como elemento do composto.

Todas as partes que estão em contacto com a água são compostos em latão não contendo níquel.

Deste modo garante-se o cumprimento da adequação a uso alimentar, mantendo sempre a garantia de qualidade da Ctesi.

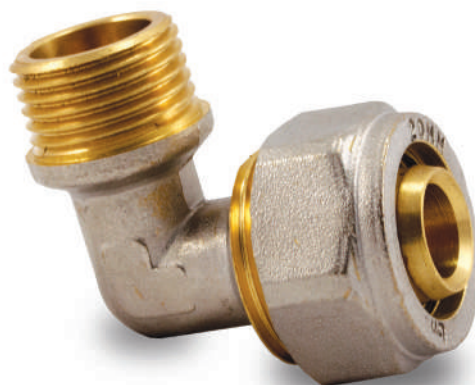



	B	C	D
4023000	16	33	33
4023001	20	35	35
4023002	25	42	42

medidas em mm

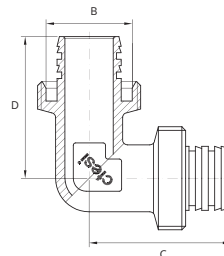

JOELHOS SIMPLES

REF.	MEDIDAS			€
4023000	16	16	96	4.30
4023001	20	12	72	6.25
4023002	25	8	48	9.50



	B	E	C	D
4023050	16	20	36	42
4023051	20	25	38	43

medidas em mm

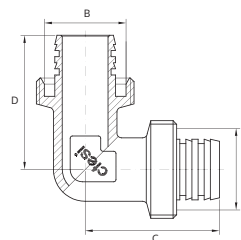

JOELHOS REDUÇÃO

REF.	MEDIDAS			€
4023050	16 x 20	12	72	5.60
4023051	20 x 25	8	48	9.04



	A	B	C	D
4023100	1/2"	16	36	33
4023101	1/2"	20	36	32
4023102	3/4"	20	38	34
4023103	3/4"	25	42	39

medidas em mm

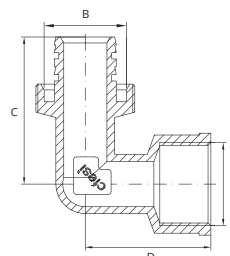

JOELHOS ROSCA FÊMEA

REF.	MEDIDAS			€
4023100	16 x 1/2"	12	96	4.35
4023101	20 x 1/2"	13	78	4.82
4023102	20 x 3/4"	12	72	5.47
4023103	25 x 3/4"	8	48	7.57



	A	B	C	D
4023150	1/2"	16	32	32
4023151	1/2"	20	36	31
4023152	3/4"	20	38	33
4023153	3/4"	25	42	36

medidas em mm

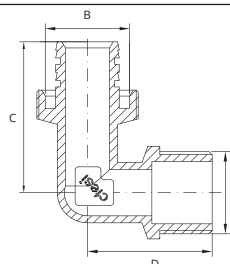

JOELHOS ROSCA MACHO

REF.	MEDIDAS			€
4023150	16 x 1/2"	20	120	3.36
4023151	20 x 1/2"	15	90	4.48
4023152	20 x 3/4"	12	72	5.21
4023153	25 x 3/4"	8	48	6.58



	A	B	C	D
4023200	1/2"	16	35	42
4023203	3/4"	16	40	46
4023201	1/2"	20	37	43
4023202	3/4"	20	40	46

medidas em mm

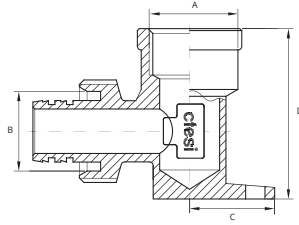

JOELHOS PATER

REF.	MEDIDAS			€
4023200	16 x 1/2"	14	84	5.38
4023203	16 x 3/4"	12	72	7.06
4023201	20 x 1/2"	12	72	5.77
4023202	20 x 3/4"	10	60	7.10



	A	B	C
4023550	1/2"	16	36.5
4023551	1/2"	20	34.5
4023554	3/4"	16	37.5
4023555	3/4"	20	34.5
4023556	3/4"	25	37

medidas em mm

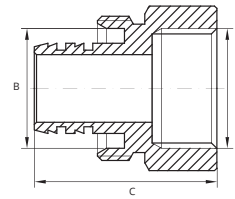

CASQUILHOS FÊMEA

REF.	MEDIDAS			€
4023550	16 x 1/2"	25	150	3.37
4023551	20 x 1/2"	20	120	4.27
4023554	16 x 3/4"	20	120	3.67
4023555	20 x 3/4"	18	108	4.66
4023556	25 x 3/4"	10	60	5.64

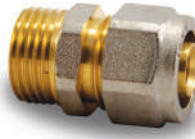

	A	B	C
4023600	1/2"	16	38
4023601	1/2"	20	40.5
4023604	3/4"	16	39.5
4023605	3/4"	20	41.5
4023606	3/4"	25	44.5

medidas em mm

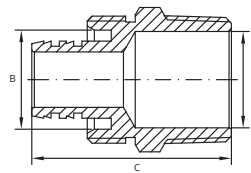

CASQUILHOS MACHO

REF.	MEDIDAS			€
4023600	16 x 1/2"	30	180	2.68
4023601	20 x 1/2"	20	120	4.44
4023604	16 x 3/4"	15	150	3.37
4023605	20 x 3/4"	18	108	4.74
4023606	25 x 3/4"	10	60	6.57



	B	C
4023450	16	46
4023451	20	50
4023452	25	50

medidas em mm

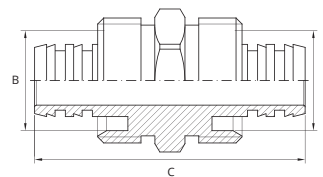

UNIÕES SIMPLES

REF.	MEDIDAS			€
4023450	16	25	150	4.18
4023451	20	12	72	7.32
4023452	25	7	42	10.55



	B	E	C
4023500	16	20	45
4023501	20	25	49.5

medidas em mm

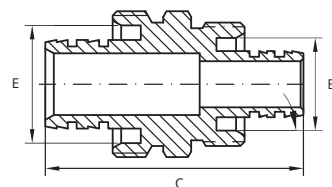

UNIÕES REDUÇÃO

REF.	MEDIDAS			€
4023500	16 x 20	16	96	5.14
4023501	25 x 20	7	42	8.76



	B	C	D
4023250	16	67	33.5
4023251	20	72	36
4023252	25	82	39

medidas em mm

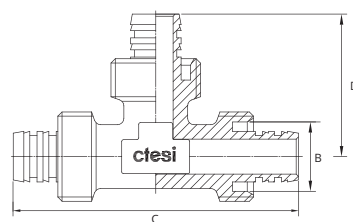

TÊS SIMPLES

REF.	MEDIDAS			€
4023250	16	12	72	6.50
4023251	20	8	48	9.48
4023252	25	4	24	13.74



	E	F	G	C	D
4023300	20	16	16	64.5	32
4023301	20	16	20	67	32
4023304	25	20	25	70	39

medidas em mm

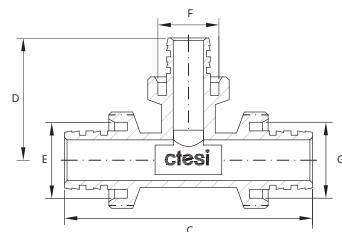

TÊS REDUÇÃO

REF.	MEDIDAS			€
4023300	20 x 16 x 16	10	60	6.94
4023301	20 x 16 x 20	10	60	8.20
4023304	25 x 20 x 25	4	24	11.40



	A	B	C	D
4023350	1/2"	16	70	30
4023351	1/2"	20	76	32
4023352	3/4"	20	76	32
4023353	3/4"	25	82	39

medidas em mm

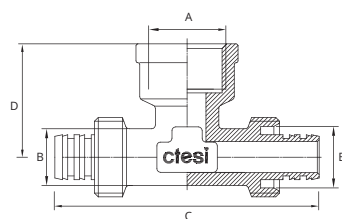

TÊS ROSCA FÊMEA

REF.	MEDIDAS			€
4023350	16 x 1/2" x 16	12	72	6.72
4023351	20 x 1/2" x 20	8	48	8.40
4023352	20 x 3/4" x 20	8	48	15.10
4023353	25 x 3/4" x 25	5	30	21.80



	A	B	C	D
4021000	38.5	38.5	Ø16	Ø16
4021002	40	40	Ø20	Ø20
4021003	48.5	48.5	Ø25	Ø25
4021004	54	54	Ø32	Ø32

medidas em mm

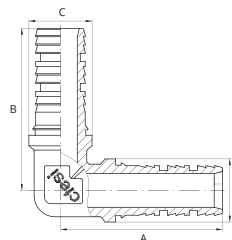

JOELHOS SIMPLES

REF.	MEDIDAS			€
4021000	16	20	120	1.73
4021002	20	16	96	3.70
4021003	25	8	48	7.06
4021004	32	5	30	10.22



	A	B	C	D
4021020	40	27	G1/2"	Ø16
4021021	42	29	G3/4"	Ø16
4021022	40	27	G1/2"	Ø20
4021023	44	30	G3/4"	Ø20
4021024	49.5	32	G1/2"	Ø25
4021025	50.5	32	G3/4"	Ø25
4021026	56.5	38	G1	Ø32

medidas em mm

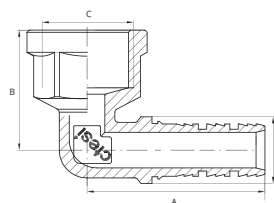

JOELHOS ROSCA FÊMEA

REF.	MEDIDAS			€
4021020	16 x 1/2"	20	120	3.45
4021021	16 x 3/4"	16	96	4.20
4021022	20 x 1/2"	16	96	4.00
4021023	20 x 3/4"	12	72	5.09
4021024	25 x 1/2"	12	72	5.73
4021025	25 x 3/4"	12	72	6.62
4021026	32 x 1"	5	30	10.08



	A	B	C	D
4021040	38.5	25	G1/2"	Ø16
4021041	41.5	28	G3/4"	Ø16
4021042	38.5	27	G1/2"	Ø20
4021043	41	29	G3/4"	Ø20
4021044	48.5	31.5	G3/4"	Ø25

medidas em mm

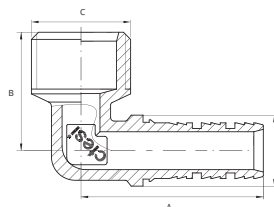

JOELHOS ROSCA MACHO

REF.	MEDIDAS			€
4021040	16 x 1/2"	20	120	2.52
4021041	16 x 3/4"	15	90	3.26
4021042	20 x 1/2"	20	120	3.11
4021043	20 x 3/4"	15	90	3.75
4021044	25 x 3/4"	10	60	5.38



	A	B	C	D
4021060	41.4	Ø16	G1/2"	39
4021061	41.4	Ø20	G1/2"	39
4021062	44	Ø16	G3/4"	41
4021063	44.5	Ø20	G3/4"	39

medidas em mm

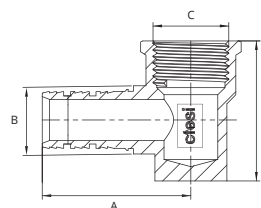

JOELHOS PATER

REF.	MEDIDAS			€
4021060	16 x 1/2"	12	72	5.09
4021061	20 x 1/2"	8	48	5.53
4021062	16 x 3/4"	8	48	5.92
4021063	20 x 3/4"	6	42	6.42



	A	B	C	D	E	F
4021100	71	35.5	Ø16	35.5	Ø16	Ø16
4021102	75	37.5	Ø20	37.5	Ø20	Ø20
4021103	92	46	Ø25	46	Ø25	Ø25
4021104	102	51	Ø32	51	Ø32	Ø32

medidas em mm

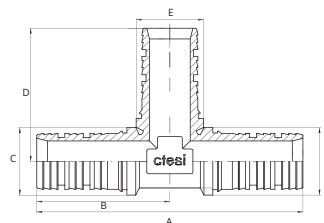

TÊS SIMPLES

REF.	MEDIDAS			€
4021100	16	16	96	3.21
4021102	20	12	72	5.04
4021103	25	5	30	8.49
4021104	32	3	18	14.42



	A	B	C	D	E	F
4021130	Ø20	71	35.5	Ø16	37.5	Ø16
4021131	Ø20	71	35.5	Ø20	37.5	Ø16
4021133	Ø20	75	37.5	Ø16	37.5	Ø20
4021140	Ø25	84	42	Ø25	39.5	Ø16
4021142	Ø25	81.5	37.5	Ø20	39.5	Ø20
4021143	Ø25	88	44	Ø25	39.5	Ø20
4021144	Ø25	87	39.5	Ø20	47.5	Ø25
4021153	Ø32	96	48	Ø32	49	Ø25

medidas em mm

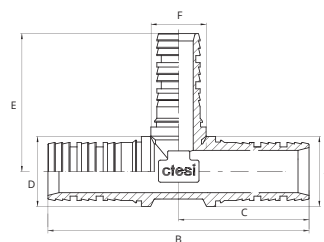

TÊS REDUÇÃO

REF.	MEDIDAS			€
4021130	20 x 16 x 16	12	72	3.95
4021131	20 x 16 x 20	12	72	4.40
4021133	20 x 20 x 16	12	72	4.45
4021140	25 x 16 x 25	6	30	7.32
4021142	25 x 20 x 20	6	30	6.52
4021143	25 x 20 x 25	6	30	7.42
4021144	25 x 25 x 20	6	30	7.16
4021153	32 x 25 x 32	3	18	12.20



	A	B	C	D
4021180	83	27	G1/2"	Ø16
4021181	83	29	G1/2"	Ø20
4021182	102	32	G3/4"	Ø25

medidas em mm

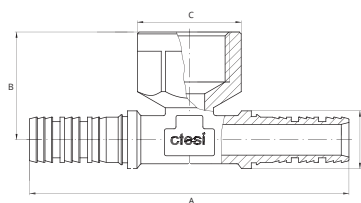

TÊS ROSCA FÊMEA

REF.	MEDIDAS			€
4021180	16 x 1/2" x 16	12	72	4.74
4021181	20 x 1/2" x 20	12	72	5.83
4021182	25 x 3/4" x 25	5	30	10.20



	A	B	C	D
4021200	52	25	Ø16	Ø16
4021202	52	25	Ø20	Ø20
4021202	65	31	Ø25	Ø25
4021204	69	33	Ø32	Ø32

medidas em mm

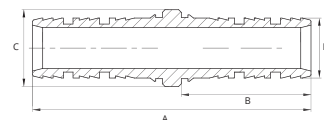

UNIÕES SIMPLES

REF.	MEDIDAS			€
4021200	16	24	144	1.73
4021202	20	20	120	2.52
4021203	25	12	72	4.60
4021204	32	8	48	7.12



	A	B	C	D
4021220	52	25	Ø20	Ø16
4021223	58	25	Ø20	Ø25
4021225	67	31	Ø25	Ø32

medidas em mm

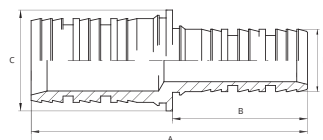

UNIÕES REDUÇÃO

REF.	MEDIDAS			€
4021220	20 x 16	20	120	2.13
4021223	25 x 20	12	72	3.61
4021225	32 x 25	8	48	6.07



	A	B	C	D
4021300	41	25.4	G1/2"	Ø16
4021301	43	25.4	G3/4"	Ø16
4021302	41.4	25.4	G1/2"	Ø20
4021303	43.4	25.4	G3/4"	Ø20
4021304	50	31.9	G1/2"	Ø25
4021305	50	31.9	G3/4"	Ø25
4021306	52	33.9	G1"	Ø32

medidas em mm

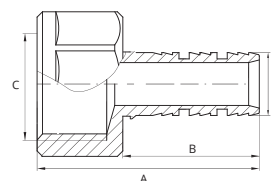

CASQUILHOS FÊMEA

REF.	MEDIDAS			€
4021300	16 x 1/2"	24	144	2.37
4021301	16 x 3/4"	16	96	3.85
4021302	20 x 1/2"	20	120	2.67
4021303	20 x 3/4"	16	96	4.05
4021304	25 x 1/2"	8	48	3.70
4021305	25 x 3/4"	12	72	4.60
4021306	32 x 1"	8	48	6.96



	A	B	C	D
4021320	45	25	G1/2"	Ø16
4021321	45	25	G3/4"	Ø16
4021323	45.5	25	G1/2"	Ø20
4021324	46.5	25	G3/4"	Ø20
4021326	53	31	G3/4"	Ø25
4021328	58.5	33	G1"	Ø32

medidas em mm

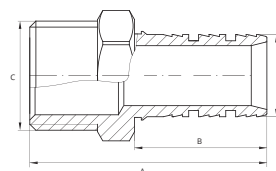

CASQUILHOS MACHO

REF.	MEDIDAS			€
4021320	16 x 1/2"	24	144	2.22
4021321	16 x 3/4"	20	120	2.22
4021323	20 x 1/2"	24	144	2.57
4021324	20 x 3/4"	16	96	3.41
4021326	25 x 3/4"	12	72	4.30
4021328	32 x 1"	8	48	7.16



	A	B	C	D	E
4021340	14.5	G1/2"	41.5	25	Ø16
4021342	14.5	G1/2"	43	25	Ø20
4021343	16	G3/4"	43	25	Ø20
4021344	16	G3/4"	49	31	Ø25

medidas em mm

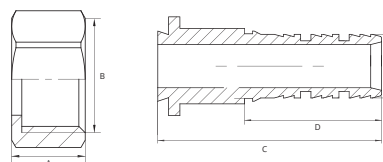

CASQUILHOS FÊMEA C/ PORCA

REF.	MEDIDAS			€
4021340	16 x 1/2"	24	144	2.57
4021342	20 x 1/2"	20	120	3.36
4021343	20 x 3/4"	16	96	4.35
4021344	25 x 3/4"	12	72	7.85



	A	B	C	D	E
4021550	72.5	90.5	Ø16	42.5	Ø12
4021551	72.5	90.5	Ø20	42.5	Ø12
4021552	76.1	105	Ø25	49.5	Ø15

medidas em mm

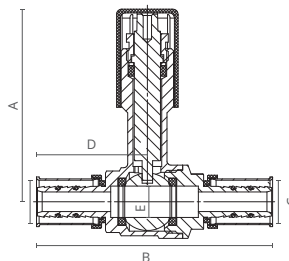

VÁLVULAS ESFERA S/ MANÍPULO

REF.	MEDIDAS			€
4021550	16	6	24	10.90
4021551	20	6	24	11.90
4021552	25	6	24	16.90

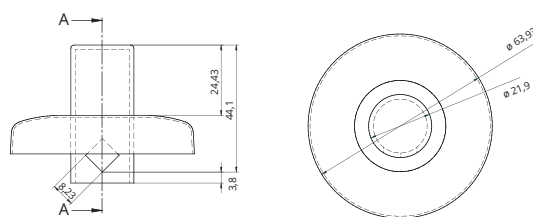

MANÍPULO

REF.	DESIGNAÇÃO			€
4021562	ROSCA OCULTA	5	50	5.35

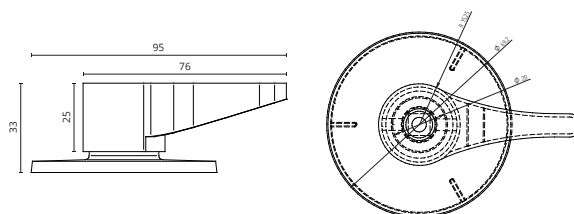

MANÍPULO ALAVANCA

REF.	DESIGNAÇÃO			€
4021561	ALAVANCA			7.00

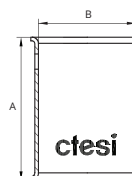

ANILHAS COMPRESSÃO

	A	B
4021460	23.5	Ø16
4021461	23.5	Ø20
4021462	31	Ø25
4021463	31	Ø32

medidas em mm

REF.	MEDIDAS			€
4021460	16	10	100	0.48
4021461	20	10	100	0.68
4021462	25	10	100	1.30
4021463	32	10	100	1.54

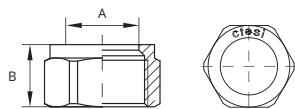

PORCA

REF.	MEDIDAS			€
4023700	16 x 14	10	100	0.95
4023701	20 x 15	10	100	1.30
4023702	25 x 15	10	100	1.75

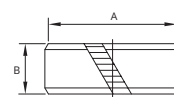

ANILHA

REF.	MEDIDAS			€
4023750	16 x 8	10	100	0.40
4023751	20 x 8	10	100	0.56
4023752	25 x 8.5	10	100	0.72



CALIBRADOR

REF.	MEDIDAS			€
4021910	Ø16 x 18 x 20	1	100	5.50
4021911	Ø20 x 25 x 32	1	100	5.50



ABRAÇADEIRA CLIP

REF.	MEDIDAS			€
4023910	16	100	800	0.13
4023911	20	100	700	0.18
4023912	25	100	400	0.23
4023913	32	50	200	0.65



TESOURA

REF.	MEDIDAS			€
4021980	16 - 32	1	20	11.00

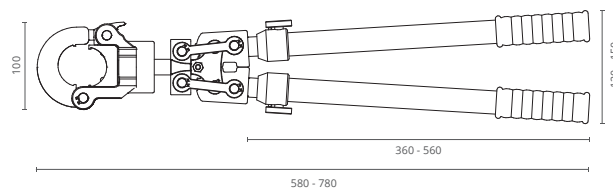

AMPLITUDE DE CRAVAMENTO	DIAM. 16 - 32 (mm)
FORÇA	1,1T
COMPRIMENTO (MIN-MÁX)	560 - 770 mm
MATRIZES	16; 20; 25; 32 (mm)

ALICATE CABEÇA ROTATIVA

REF.	MEDIDAS			€
4021905	16 - 32	1	-	226.60

FORNECIDO COM MALA. INCLUI MATRIZES 16, 20, 25 E 32.

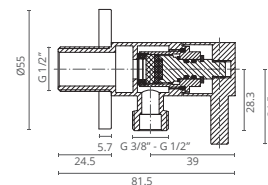

CILÍNDRICA

REF.	MEDIDAS			€
CT2262020	1/2" x 3/8"	5	100	8.10
CT2262021	1/2" x 1/2"	5	100	8.30

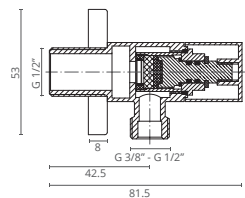

QUADRADA

REF.	MEDIDAS			€
CT2262040	1/2" x 3/8"	5	100	9.80
CT2262041	1/2" x 1/2"	5	100	10.00

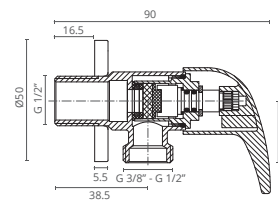

MONOCOMANDO

REF.	MEDIDAS			€
CT2262000	1/2" x 3/8"	10	100	8.45
CT2262001	1/2" x 1/2"	10	100	8.65

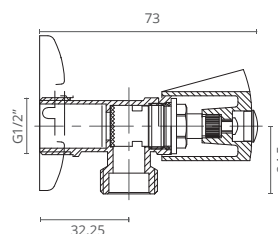

QUICK

REF.	MEDIDAS			€
5032402	1/2" x 1/2"	10	50	5.40

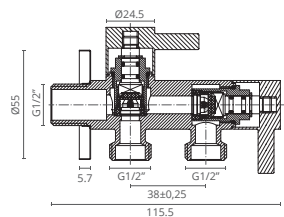

CILÍNDRICA DUPLA

REF.	MEDIDAS			€
CT2262220	1/2" x 1/2" x 1/2"	5	50	18.90

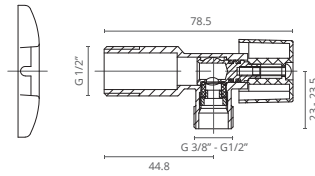

NORMAL

REF.	MEDIDAS			€
5032020	1/2" x 3/8"	20	100	3,10
5032021	1/2" x 1/2"	20	100	3,20

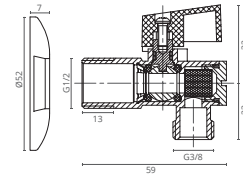

MINI C/ FILTRO

REF.	MEDIDAS			€
5034210	1/2" x 3/8"	20	100	3,80
5034211	1/2" x 1/2"	10	100	4,00
5034212	1/2" x 3/4"	10	100	4,20

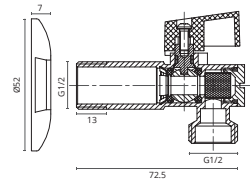

LONGA C/ FILTRO

REF.	MEDIDAS			€
5034401	1/2" x 3/8"	20	100	4,30
5034402	1/2" x 1/2"	20	100	4,55

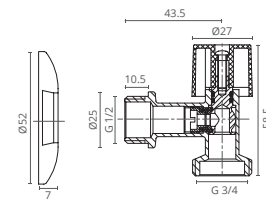

MÁQUINA DE LAVAR

REF.	MEDIDAS			€
5032022	1/2" x 3/4"	10	100	3,30



- A** CONTROLO SAÍDA 3/4"
- B** CONTROLO SAÍDA 3/8"

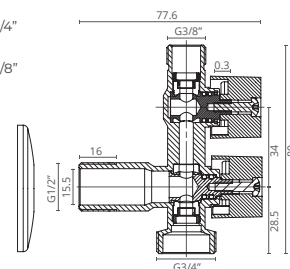

DUPLA

REF.	MEDIDAS			€
5032300	1/2" x 3/4" x 3/8"	10	50	8,90



	A	B	C	D	E	F	G	H	I
5011001	G 1/2"	ø14	83,5	48,5	ø27,7	G 1/2"	9,5	9,5	43,7
5011002	G 3/4"	ø17	95,5	52	ø33	G 3/4"	11	11	50
5011003	G 1"	ø22	108	62	ø41,5	G 1"	11,5	11,5	57,5
5011004	G 1.1/4"	ø30	131	68,80	ø52,5	G 1.1/4"	13,5	13,5	71
5011005	G 1.1/2"	ø37	145	83	ø63	G 1.1/2"	14	14	80
5011006	G 2"	ø45	165	90,5	ø77	G 2"	15	15	96

medidas em mm



	A	B	C	D	E	F	G	H	I
5011101	G 1/2"	ø14	83,5	48,5	ø27,7	G 1/2"	9	9,5	49,2
5011102	G 3/4"	ø17	95,5	52	ø32	G 3/4"	11	11	56
5011103	G 1"	ø22	108	62	ø41,5	G 1"	11	11,5	63,2

medidas em mm



	A	B	C	D	E	F	G	H	I
5011050	G 1/2"	ø14	49	40	ø27,7	G 1/2"	9,5	9,5	43,7
5011051	G 3/4"	ø17	49	42	ø33	G 3/4"	11	11	50
5011052	G 1"	ø22	60,5	51	ø41,5	G 1"	11,5	11,5	57,4

medidas em mm



	A	B	C	D	E	F	G	H	I
5011150	G 1/2"	ø14	49	40	ø27,7	G 1/2"	9	9,5	49,2
5011151	G 3/4"	ø17	49	42	ø33	G 3/4"	11	11	56
5011152	G 1"	ø22	60,5	51	ø41,5	G 1"	11,5	11,5	57

medidas em mm



	A	B	C	D	E	F	G	H	I
5040101	80	50	-	ø30	44	44	41	ø10	G 1/2"
5040102	91	56,5	-	ø38,5	47,5	43	48	ø12	G 3/4"
5040103	95,5	59,5	ø38	ø46,5	60	48,5	58	ø14	G 1"

medidas em mm

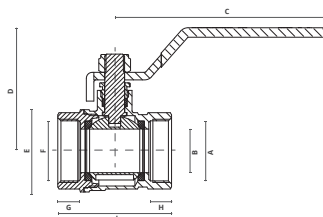

F/F
STD PASSAGEM STANDARD

REF.	MEDIDAS			€
5011001	1/2"	20	80	4.30
5011002	3/4"	10	40	6.40
5011003	1"	6	24	10.50
5011004	1.1/4"	5	20	14.30
5011005	1.1/2"	2	8	22.50
5011006	2"	2	8	32.60

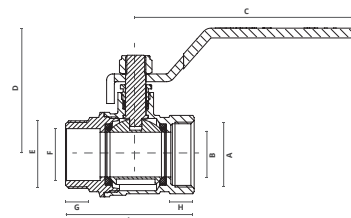

M/F
STD PASSAGEM STANDARD

REF.	MEDIDAS			€
5011101	1/2"	20	80	4.30
5011102	3/4"	10	40	6.40
5011103	1"	6	24	10.50

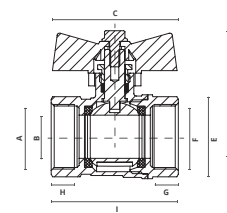

F/F
STD MANÍPULO CURTO PASSAGEM STANDARD

REF.	MEDIDAS			€
5011050	1/2"	25	100	3.60
5011051	3/4"	15	60	5.70
5011052	1"	10	40	9.70

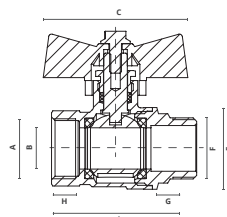

M/F
STD MANÍPULO CURTO PASSAGEM STANDARD

REF.	MEDIDAS			€
5011150	1/2"	25	100	3.50
5011151	3/4"	15	60	5.90
5011152	1"	9	36	9.80

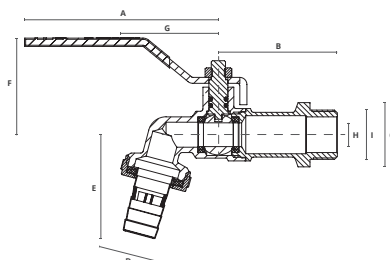

STD
TORNEIRA DE SERVIÇO

REF.	MEDIDAS			€
5040101	1/2"	10	100	5.30
5040102	3/4"	8	80	7.90
5040103	1"	5	50	13.10

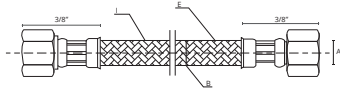

I	EPDM	E	AÇO INOX
A	DN INTERIOR 8mm	B	DN EXTERIOR 12mm
PRESSÃO DE TRABALHO 10 BAR			
INTERVALO DE TEMPERATURA -10°C/90°C			

F/F
3/8" x 3/8"

REF.	MEDIDAS			€
0700015	15 cm	10	200	1.52
0700020	20 cm	10	100	1.61
0700025	25 cm	10	100	1.69
0700030	30 cm	10	100	1.78
0700035	35 cm	10	100	1.86
0700040	40 cm	10	100	1.95
0700045	45 cm	10	100	2.04
0700050	50 cm	10	100	2.12

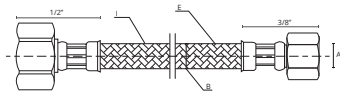

I	EPDM	E	AÇO INOX
A	DN INTERIOR 8mm	B	DN EXTERIOR 12mm
PRESSÃO DE TRABALHO 10 BAR			
INTERVALO DE TEMPERATURA -10°C/90°C			

F/F
1/2" x 3/8"

REF.	MEDIDAS			€
0702015	15 cm	10	200	1.65
0702020	20 cm	10	100	1.74
0702025	25 cm	10	100	1.83
0702030	30 cm	10	100	1.91
0702035	35 cm	10	100	1.99
0702040	40 cm	10	100	2.08
0702045	45 cm	10	100	2.16
0702050	50 cm	10	100	2.26

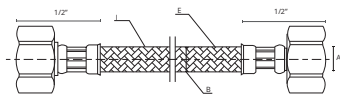

I	EPDM	E	AÇO INOX
A	DN INTERIOR 8mm	B	DN EXTERIOR 12mm
PRESSÃO DE TRABALHO 10 BAR			
INTERVALO DE TEMPERATURA -10°C/90°C			

F/F
1/2" x 1/2"

REF.	MEDIDAS			€
0704015	15 cm	10	200	1.68
0704020	20 cm	10	100	1.76
0704025	25 cm	10	100	1.84
0704030	30 cm	10	100	1.92
0704035	35 cm	10	100	2.00
0704040	40 cm	10	100	2.08
0704045	45 cm	10	100	2.17
0704050	50 cm	10	100	2.24
0704060	60 cm	10	100	2.40
0704080	80 cm	10	100	2.92
0704100	100 cm	10	50	3.26

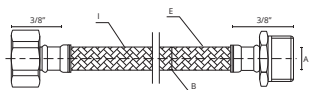

I	EPDM	E	AÇO INOX
A	DN INTERIOR 8mm	B	DN EXTERIOR 12mm
PRESSÃO DE TRABALHO 10 BAR			
INTERVALO DE TEMPERATURA -10°C/90°C			

M/F
3/8" x 3/8"

REF.	MEDIDAS			€
0701015	15 cm	10	200	1.52
0701020	20 cm	10	100	1.61
0701025	25 cm	10	100	1.69
0701030	30 cm	10	100	1.78
0701035	35 cm	10	100	1.86
0701040	40 cm	10	100	1.95
0701045	45 cm	10	100	2.04
0701050	50 cm	10	100	2.12

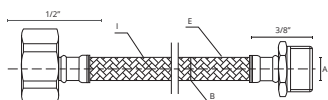

I	EPDM	E	AÇO INOX
A	DN INTERIOR 8mm	B	DN EXTERIOR 12mm
PRESSÃO DE TRABALHO 10 BAR			
INTERVALO DE TEMPERATURA -10°C/90°C			

M/F
1/2" x 3/8"

REF.	MEDIDAS			€
0703015	15 cm	10	200	1.65
0703020	20 cm	10	100	1.74
0703025	25 cm	10	100	1.83
0703030	30 cm	10	100	1.91
0703035	35 cm	10	100	1.99
0703040	40 cm	10	100	2.08
0703045	45 cm	10	100	2.16
0703050	50 cm	10	100	2.26

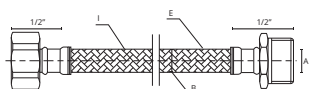

I	EPDM	E	AÇO INOX
A	DN INTERIOR 8mm	B	DN EXTERIOR 12mm
PRESSÃO DE TRABALHO 10 BAR			
INTERVALO DE TEMPERATURA -10°C/90°C			

M/F
1/2" x 1/2"

REF.	MEDIDAS			€
0705015	15 cm	10	200	1.68
0705020	20 cm	10	100	1.76
0705025	25 cm	10	100	1.84
0705030	30 cm	10	100	1.92
0705035	35 cm	10	100	2.00
0705040	40 cm	10	100	2.08
0705045	45 cm	10	100	2.17
0705050	50 cm	10	100	2.24

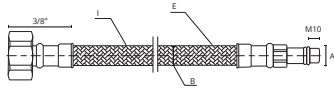

I	EPDM	E	AÇO INOX
A	DN INTERIOR 8mm	B	DN EXTERIOR 12mm
PRESSÃO DE TRABALHO 10 BAR			
INTERVALO DE TEMPERATURA -10°C/90°C			

**3/8" M10
PARA MONOCOMANDO**

REF.	MEDIDAS			€
0725030	30 cm	10	100	1.76
0725035	35 cm	10	100	1.80
0725040	40 cm	10	100	1.93
0725050	50 cm	10	100	2.26
0725060	60 cm	10	100	2.48

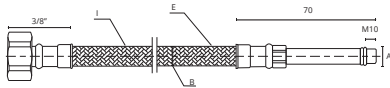

I	EPDM	E	AÇO INOX
A	DN INTERIOR 8mm	B	DN EXTERIOR 12mm
PRESSÃO DE TRABALHO 10 BAR			
INTERVALO DE TEMPERATURA -10°C/90°C			

**3/8" LONGA M10
PARA MONOCOMANDO**

REF.	MEDIDAS			€
0727035	35 cm	10	100	3.07
0727050	50 cm	10	100	3.46

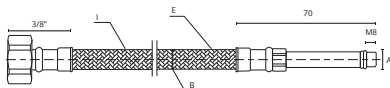

I	EPDM	E	AÇO INOX
A	DN INTERIOR 8mm	B	DN EXTERIOR 12mm
PRESSÃO DE TRABALHO 10 BAR			
INTERVALO DE TEMPERATURA -10°C/90°C			

**3/8" LONGA M8
PARA MONOCOMANDO**

REF.	MEDIDAS			€
0729035	35 cm	2	150	4.25

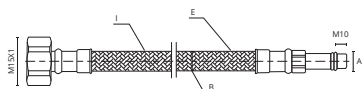

I	EPDM	E	AÇO INOX
A	DN INTERIOR 8mm	B	DN EXTERIOR 12mm
PRESSÃO DE TRABALHO 10 BAR			
INTERVALO DE TEMPERATURA -10°C/90°C			

PARA MONOCOMANDO COZINHA C/ CHUVEIRO

REF.	MEDIDAS			€
0725025	20 cm	1	150	3.29

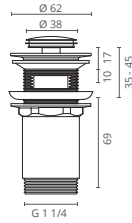

CLICK CLACK
VÁLVULA LAVATÓRIO

REF.	MEDIDAS			€
CT2100000	1,1/4"	10	50	10.80

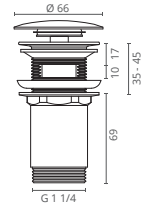

CLICK CLACK
VÁLVULA LAVATÓRIO GRANDE

REF.	MEDIDAS			€
CT2100010	1,1/4"	1	50	13.40

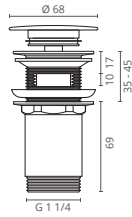

CLICK CLACK
VÁLVULA LAVATÓRIO PLANA

REF.	MEDIDAS			€
CT2100030	1,1/4"	1	50	14.20

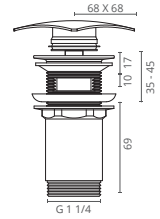

CLICK CLACK
VÁLVULA LAVATÓRIO QUADRADA

REF.	MEDIDAS			€
CT2100020	1,1/4"	1	50	16.10

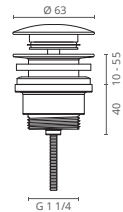

CLICK CLACK
VÁLVULA LAVATÓRIO C/ PARAFUSO

REF.	MEDIDAS			€
CT2100040	1,1/4"	1	50	13.90

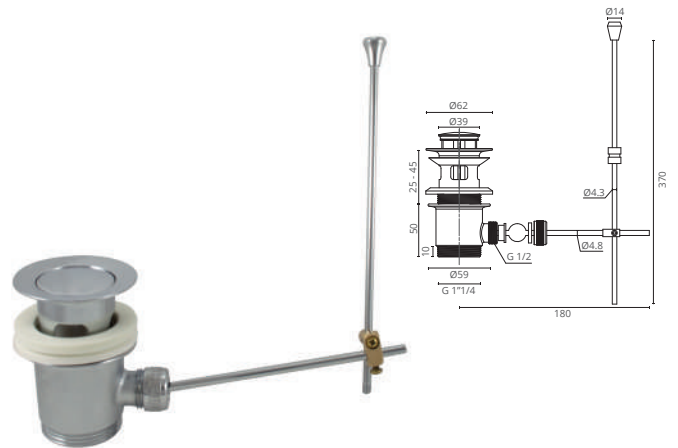

VÁLVULA LAVATÓRIO AUTOMÁTICA C/ VARETA

REF.	MEDIDAS			€
CT2100050	1,1/4"	1	50	12.30

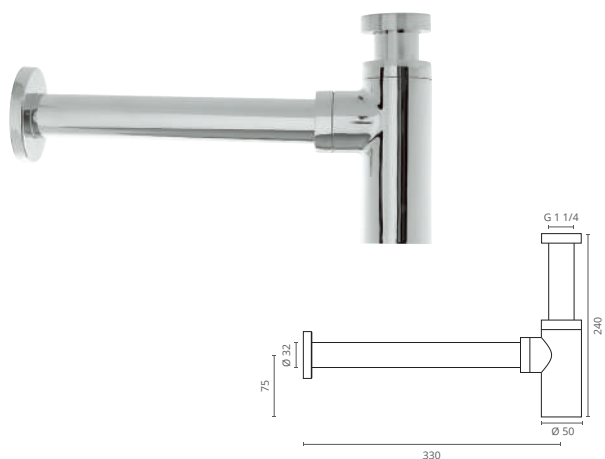

LINEA

REF.	MEDIDAS			€
CT2102000	TUBO 30 cm	1	20	36.60

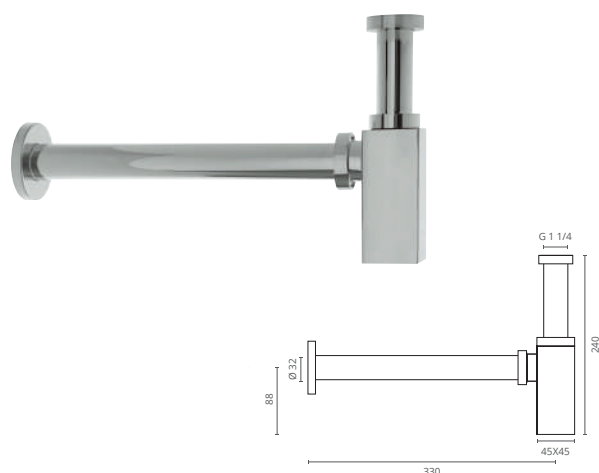

QUADRO

REF.	MEDIDAS			€
CT2102030	TUBO 30 cm	1	20	49.30

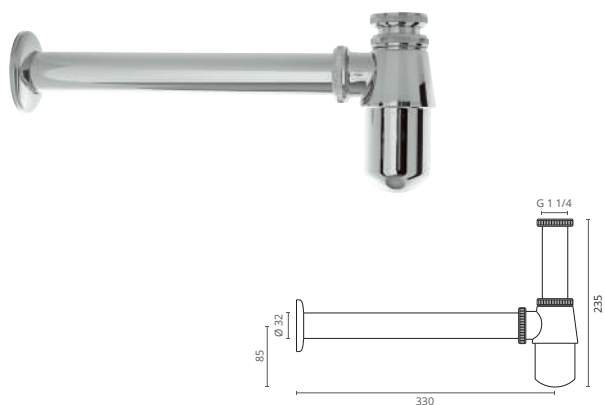

GARRAFA

REF.	MEDIDAS			€
CT2102101	TUBO 30 cm	1	20	18.70



TUBO FLEXÍVEL

REF.	MEDIDAS			€
CT2102520	Ø32 x 30 cm	1	100	7.50



TUBO SIMPLES

REF.	MEDIDAS			€
CT2102501	Ø32 x 30 cm	1	-	4.90
CT2102503	Ø32 x 40 cm	1	-	6.80
CT2102504	Ø32 x 50 cm	1	-	8.60



TUBO SIMPLES C/ ABA

REF.	MEDIDAS			€
CT2102541	Ø32 x 30 cm	1	-	5.10
CT2102543	Ø32 x 40 cm	1	-	6.90
CT2102544	Ø32 x 50 cm	1	-	8.80

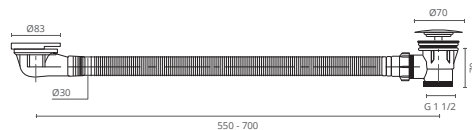

CLICK CLACK PVC

REF.	MEDIDAS			€
CT2100250	1 1/2" x 40	1	20	20.80

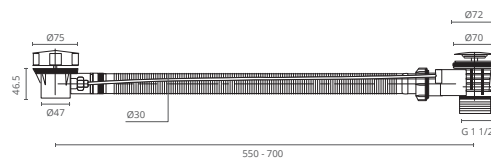

AUTOMÁTICA PVC

REF.	MEDIDAS			€
CT2100260	1 1/2" x 40	1	20	28.80

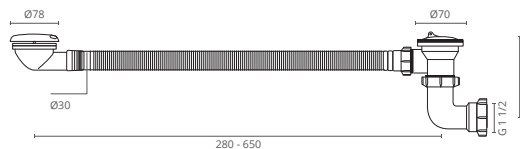

VÁLVULA BANHEIRA PVC C/ CURVA

REF.	MEDIDAS			€
BK2013100	1 1/2" x 40 VB-03	5	50	8.40

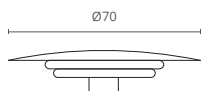

TAMPÃO VÁLVULA CLICK

REF.	ACABAMENTO			€
CT2100295	CROMADO	1	-	3.80

ACESSÓRIO NÃO COMPATÍVEL COM VÁLVULA BANHEIRA PVC C/ CURVA

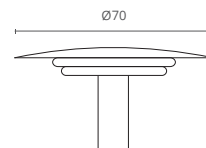

TAMPÃO VÁLVULA AUTOMÁTICA

REF.	ACABAMENTO			€
CT2100290	CROMADO	1	-	4.80

ACESSÓRIO NÃO COMPATÍVEL COM VÁLVULA BANHEIRA PVC C/ CURVA



TAMPÃO P/ VÁLVULA CLICK CLACK

REF.	MODELO	MATERIAL			€
CT2260380	CLICK CLACK	LATÃO	1	-	1.70
CT2260381	CLICK CLACK GRANDE	LATÃO	1	-	4.40



TAMPÃO P/ VÁLVULA CLICK CLACK

REF.	MODELO	MATERIAL			€
CT2260382	CLICK CLACK QUADRADA	LATÃO	1	-	6.40



TAMPÃO P/ VÁLVULA AUTOMÁTICA

REF.	MATERIAL			€
CT2260320	ABS / INOX	1	-	3.20



VEDANTE P/ TAMPÃO

REF.	MODELO			€
CT2260390	CLICK CLACK	10	-	0.65



VEDANTE SUPERIOR P/ VÁLVULA

REF.	MODELO			€
CT2260396	CLICK CLACK	1	-	1.50



VEDANTE INFERIOR P/ VÁLVULA

REF.	MODELO			€
CT2260395	CLICK CLACK	1	-	1.75

VEDANTE SUPERIOR FINO P/ VÁLVULA

REF.	MODELO			€
CT2260397	CLICK CLACK	1	-	1.20

MOLA P/ VÁLVULA CLICK CLACK

REF.	MATERIAL			€
CT2260385	LATÃO	1	-	2.10



VARETA P/ VÁLVULA AUTOMÁTICA

REF.	ACABAMENTO			€
CT2260110	CROMADO	1	-	2.94



UNIÃO P/ VARETA

REF.	MATERIAL			€
CT2260150	ABS	1	-	0.86

PERLADORES ECONOMIZADORES

Os perlatores são componentes imprescindíveis para a poupança de água.

Previnem a acumulação dos pequenos detritos calcários e a limitação do caudal da água.

Com a nossa gama de Perlatores economizadores conseguirá uma redução de água até 50% nas torneiras da sua casa. Estes perlatores tem a função de misturar o ar com água, devido às suas aberturas laterais que permitem a entrada de ar, dando a mesma sensação de fluxo e pressão da água mas conseguindo uma redução bastante eficaz no seu caudal.



LAVATÓRIO

REF.	MEDIDAS			€
CT1950200	M24 x 1	10	250	1,96

CONSUMO 6 L/MIN



BANCA

REF.	MEDIDAS			€
CT1950205	F22 x 1	10	250	2,06

CONSUMO 6 L/MIN



KIT ECONOMIZADOR - INTERIOR PERLATOR

REF.	MEDIDAS			€
CT1950230	-	10	250	2,58

CONTÉM: 2 INTERIORES ECONOMIZADORES



REDUTOR CHUVEIRO

REF.	MEDIDAS			€
CT1950210	1/2"	10	200	4,15

CONSUMO 8 L/MIN



KIT ECONOMIZADOR - COMPLETO

REF.	MEDIDAS			€
CT1950225	-	6	144	9,30

CONTÉM: 2 PERLADORES ECONOMIZADORES PARA LAVATÓRIO; 1 PERLATOR ECONOMIZADOR PARA BANCA; 1 REDUTOR PARA CHUVEIRO



KIT ECONOMIZADOR - SIMPLES

REF.	MEDIDAS			€
CT1950235	-	6	168	7,40

CONTÉM: 3 INTERIORES ECONOMIZADORES E 1 REDUTOR PARA CHUVEIRO

ARTIGOS FORNECIDOS EM BLISTER



PARA UM PLANETA MAIS SUSTENTÁVEL...

Com as soluções Ctesi® Green fazemos com que pequenos gestos façam toda a diferença, poupando no consumo de água sem afetar a eficiência e o conforto no uso deste recurso essencial à vida no planeta.



LAVATÓRIO

REF.	MEDIDAS			€
CT1950000	M24 x 1	10	1000	1.55
CT1950001	M24 x 1 BLISTER	10	300	2.10

CONSUMO 14 L/MIN



LAVATÓRIO

REF.	MEDIDAS			€
CT1950080	M18 x 1	10	-	1.70
CT1950081	M18 x 1 BLISTER	5	-	2.25
CT1950090	M20 x 1	10	-	1.70
CT1950091	M20 x 1 BLISTER	5	-	2.25

CONSUMO 14 L/MIN



BANHEIRA

REF.	MEDIDAS			€
CT1950010	M28 x 1	10	1000	2.40
CT1950011	M28 x 1 BLISTER	10	-	2.95

CONSUMO 14 L/MIN



BANCA

REF.	MEDIDAS			€
CT1950005	F22 x 1	10	-	1.70
CT1950006	F22 x 1 BLISTER	10	300	2.25

CONSUMO 14 L/MIN



BIDÉ

REF.	MEDIDAS			€
CT1950015	M22 x 1	10	1000	4.30
CT1950016	M22 x 1 BLISTER	10	-	4.85

CONSUMO 14 L/MIN



INTERIOR PERLATOR C/ ANILHAS

REF.	MEDIDAS			€
CT1950020	-	10	-	1.25
CT1950021	BLISTER*	10	-	2.85

*CONTÉM: 2 INTERIORES PARA PERLADORES



BICA - RÓTULA CROMADO

REF.	MEDIDAS			€
CT1950215	F22 M24	6	150	3.35

CONSUMO 18 L/MIN. ARTIGO FORNECIDO EM BLISTER.



BICA - FLEXÍVEL CROMADO

REF.	MEDIDAS			€
CT1950220	F22 M24	6	50	5.85

CONSUMO 12 L/MIN. ARTIGO FORNECIDO EM BLISTER.



ADAPTADOR

REF.	MEDIDAS			€
CT2216000	M24/M22	10	1000	1.70

ARTIGO FORNECIDO EM BLISTER.



PERLATOR

REF.	MEDIDAS			€
CT1951250	F M16X1 HC	10	-	5.50



PERLATOR COIN

REF.	MEDIDAS			€
CT1952000	M24X1 HC A	10	-	1.05



PERLATOR CACHE

REF.	MEDIDAS			€
CT1952100	HC 3R A	10	-	4.05



PERLATOR SLIM

REF.	MEDIDAS			€
CT1952200	M24X1	10	-	2.05



PERLATOR RECTANGULAR

REF.	MEDIDAS			€
CT1952500	RC 24x6mm	10	-	14.10



PERLATOR RECTANGULAR

REF.	MEDIDAS			€
CT1952550	RC 32x8 mm	10	-	15.00



CHAVE P/ PERLATOR CACHE

REF.	MEDIDAS			€
CT1959800	STD	10	-	0.75



CHAVE P/ PERLATOR CACHE

REF.	MEDIDAS			€
CT1959801	TT	10	-	0.75



CHAVE P/ PERLATOR SLIM

REF.	MEDIDAS			€
CT1959850	SSR	10	-	0.75

BICAS

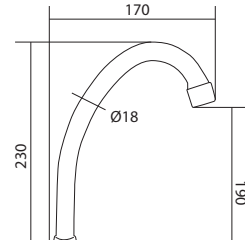

BICA "J"
UNIVERSAL

REF.	MEDIDAS			€
CT2218010	Ø18 x 220	1	100	13.80

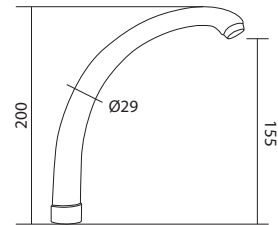

BICA SUPERIOR
CROMADA

REF.	MEDIDAS			€
CT2218050	28 x 200	1	100	14.20

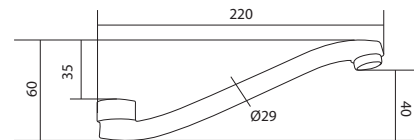

BICA INFERIOR
CROMADA

REF.	MEDIDAS			€
CT2218055	28 x 260	1	100	14.20

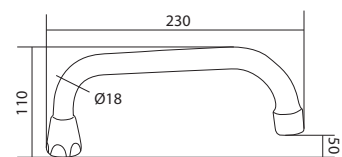

BICA "U"
UNIVERSAL

REF.	MEDIDAS			€
CT2218015	Ø18 x 220	1	100	13.80

ESPELHOS

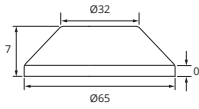

ESPELHO NORMAL

LATÃO

REF.	MEDIDAS			€
CT2120000	Ø65 mm	2	10	1,75

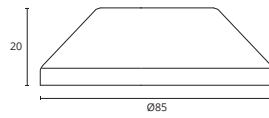

ESPELHO ESPECIAL

LATÃO

REF.	MEDIDAS			€
CT2120011	Ø85 mm	2	10	3,60

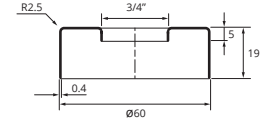
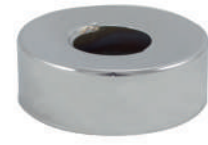

ESPELHO CILÍNDRICO

LATÃO

REF.	MEDIDAS			€
CT2120020	Ø60 mm	2	10	3,20

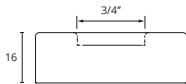

ESPELHO QUADRADO

LATÃO

REF.	MEDIDAS			€
CT2120030	70 x 70 mm	2	10	6,10

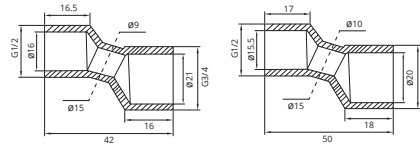

EXCÊNTRICO P/ MISTURADORA

NORMAL

REF.	MEDIDAS			€
CT2120200	H42 mm*	2	10	1,83
CT2120201	H50 mm*	2	10	2,47

EXCENRICIDADE 9 mm // *1/2" X 3/4"

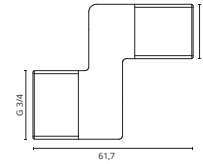

EXCÊNTRICO P/ MISTURADORA

ESPECIAL

REF.	MEDIDAS			€
CT2120210	1/2" x 3/4"	2	10	5,60



KIT EXCÊNTRICO H42

C/ ESPELHO NORMAL

REF.	ACABAMENTO			€
CT2120250	LATÃO - CROMADO	2	300	3,30

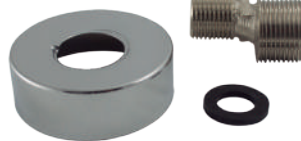

KIT EXCÊNTRICO H50

C/ ESPELHO CILÍNDRICO

REF.	ACABAMENTO			€
CT2120260	LATÃO - CROMADO	2	200	4,30



KIT EXCÊNTRICO H50

C/ ESPELHO QUADRADO

REF.	ACABAMENTO			€
CT2120270	LATÃO - CROMADO	2	200	8,40

FERRAGENS



FERRAGENS 2 PARAFUSOS

REF.	MEDIDAS			€
CT2121810	M6 x 55 mm	1	150	2,10



FERRAGENS 1 PARAFUSO PEQUENO

REF.	MEDIDAS			€
CT2121800	M8 x 55 mm	1	150	3,40



FERRAGENS 1 PARAFUSO MÉDIO

REF.	MEDIDAS			€
CT2121820	M8 x 120 mm	1	100	3,80



FERRAGENS 1 PARAFUSO GRANDE

REF.	MEDIDAS			€
CT2121830	M8 x 270 mm	1	100	5,10



EMBELEZADOR P/ CARTUCHO

REF.	MEDIDAS			€
CT9020222	35 mm - Ø40 x 1,25	1	-	1,00
CT9020227	40 mm - Ø45 x 1,25	1	-	1,10



PORCA APERTO P/ CARTUCHO

REF.	MEDIDAS			€
CT9020202	35 mm - M37 x 1,25	1	-	1,70
CT9020207	40 mm - M42 x 1,25	1	-	1,80

CASTELOS

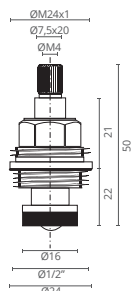

CASTELO ESTRIADO CURTO

REF.	MEDIDAS			€
CT2121000	1/2" - 8 mm	10	200	2.75

AMPLITUDE DE VEDAÇÃO ATÉ 22 mm

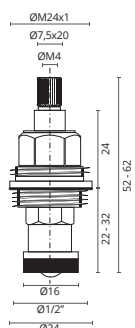

CASTELO ESTRIADO ESPECIAL

REF.	MEDIDAS			€
CT2121020	1/2" - 8 mm	10	200	3.32

AMPLITUDE DE VEDAÇÃO ATÉ 32 mm

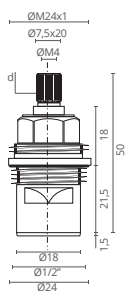

CASTELO ESTRIADO CERÂMICO 1/4" VOLTA

REF.	MEDIDAS			€
CT2121200	8 mm x 20 FRIO	10	200	4.30
CT2121201	8 mm x 20 QUENTE	10	200	4.30

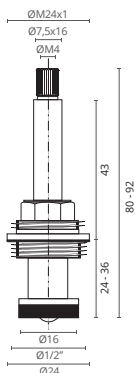

CASTELO ESTRIADO PASSADOR

REF.	MEDIDAS			€
CT2121100	1/2" - 8 mm	10	200	3.65
CT2121110	3/4" - 8 mm	10	100	4.15

CARTUCHOS

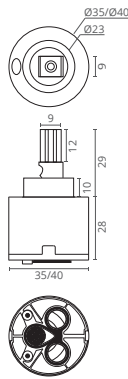

- Ângulo máximo abertura: 25°
- Temperatura máxima: 90°C
- Pressão máxima: 35 Bar
- Vida esperada: 70.000 ciclos EN817

CARTUCHO UNIVERSAL

REF.	MEDIDAS			€
CT2121410	Ø35 mm	5	80	4,70
CT2121420	Ø40 mm	5	80	4,70

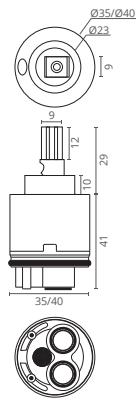

- Ângulo máximo abertura: 25°
- Temperatura máxima: 90°C
- Pressão máxima: 35 Bar
- Vida esperada: 70.000 ciclos EN817

CARTUCHO UNIVERSAL C/ DISTRIBUIDOR

REF.	MEDIDAS			€
CT2121411	Ø35 mm	5	80	4,80
CT2121421	Ø40 mm	5	80	4,80

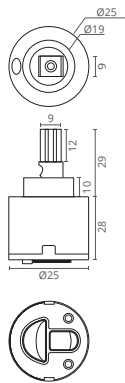

- Ângulo máximo abertura: 25°
- Temperatura máxima: 90°C
- Pressão máxima: 35 Bar
- Vida esperada: 70.000 ciclos EN817

CARTUCHO Ø25 - 1 ÁGUA

REF.	MEDIDAS			€
CT2121405	Ø25 mm	5	-	4,10

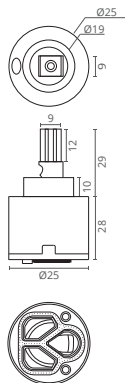

CARTUCHO Ø25

REF.	MEDIDAS			€
CT2121400	Ø25 mm	5	-	6,40



**CURTOS
CASQUILHOS**

REF.	MEDIDAS			€
1002001	3/8" x 1 cm	10	300	0.85
1002002	1/2" x 1 cm	10	300	1.13
1002003	3/4" x 1 cm	10	300	1.70



**1/2" x 3/8"
CASQUILHOS**

REF.	MEDIDAS			€
1002010	2 cm	10	300	1.35
1002011	3 cm	10	300	1.66
1002012	4 cm	10	300	2.04



**1/2" x 1/2"
CASQUILHOS**

REF.	MEDIDAS			€
1002020	2 cm	10	300	1.33
1002021	3 cm	10	300	1.65
1002022	4 cm	10	300	2.05



**3/4" x 3/4"
CASQUILHOS**

REF.	MEDIDAS			€
1002040	2 cm	10	-	2.31



**3/4" x 1/2"
CASQUILHOS**

REF.	MEDIDAS			€
1002030	1 cm	10	-	1.65
1002031	2 cm	10	-	2.28



PORCAS REDUÇÃO

REF.	MEDIDAS			€
1020301	1/2" x 3/8"	10	700	0.85
1020302	3/4" x 1/2"	10	-	1.10



**1/2" x 1/2" - Ø27
AUMENTOS**

REF.	MEDIDAS			€
1000401	1 cm	10	250	1.18
1000402	1.5 cm	10	200	1.40
1000403	2 cm	10	200	1.70
1000405	3 cm	10	150	2.28
1000407	5 cm	5	100	3.53
1000408	8 cm	5	60	5.39
1000409	10 cm	5	60	6.58



**F/F
UNIÕES**

REF.	MEDIDAS			€
1030100	1/2"	10	-	1.18



**M/F
UNIÃO REDUÇÃO**

REF.	MEDIDAS			€
1030001	1/2" x 3/8"	10	400	1.15
1030002	3/4" x 1/2"	10	300	1.48



ESPELHO SIMPLES

REF.	MEDIDAS			€
1014003	1/2" - 55 mm	25	600	0.21
1014005	1/2" - 75 mm	25	400	0.35



ESPELHO CROMADO C/ TACHO MACHO

REF.	MEDIDAS			€
1014070	1/2"	25	250	1.70



TACOS MACHO

REF.	MEDIDAS			€
1972000	3/8"	10	-	0.78
1972001	1/2"	10	-	0.87



TAMPÕES FÊMEA

REF.	MEDIDAS			€
1972004	3/8"	10	-	0.64
1972005	1/2"	10	-	0.87



PINHA RÓTULA

REF.	ACABAMENTO			€
1060005	CROMADO	5	100	11.35



ABS

PINHA RÓTULA

REF.	ACABAMENTO			€
CT2222050	CROMADO	5	20	5.30



PINHA SIMPLES

REF.	ACABAMENTO			€
1060001	CROMADO	5	100	5.25



CHUVEIRO TIPO RALO

REF.	MEDIDAS			€
1060203	10 cm	5	100	6.00



HASTES P/ CHUVEIRO

REF.	MEDIDAS			€
1062002	35 cm	5	100	6.50
1062003	40 cm	5	100	6.90
1062005	50 cm	5	100	8.10



TAPA FUROS

REF.	ACABAMENTO			€
1972060	CROMADO	10	250	1.98
1972061	BRANCO	10	250	1.88

KIT PARAFUSOS



KIT P/ LAVATÓRIO

REF.	ACABAMENTO			€
0182001	CROMADO	10	200	0,64



KIT P/ SANITA / BIDÊ

REF.	ACABAMENTO			€
0182002	CROMADO	10	200	0,92



KIT P/ SANITA / BIDÊ

REF.	MATERIAL			€
0182003	AÇO INOX	10	250	2,55



KIT P/ SANITA ROCA

REF.	ACABAMENTO			€
0182005	CROMADO	10	250	1,20

CONDIÇÕES GERAIS DE VENDA

A Barros & Moreira, S.A. e os seus clientes aceitam as seguintes condições gerais de venda a partir do momento em que a encomenda é formalizada:

1

CATÁLOGO E ENCOMENDAS

- 1.1 Os preços aqui apresentados são meramente orientativos, reservando-se a Barros & Moreira a alterações dos mesmos sem aviso prévio. A estes preços acresce IVA, à taxa legal em vigor.
- 1.2 As informações existentes em catálogo são apresentadas apenas a título informativo, sendo possível efetuar alterações sem que exista um aviso prévio por parte da Barros & Moreira.
- 1.3 A confirmação de encomenda e prazo de entrega são sempre em função das disponibilidades de stock. Não é passível de qualquer indemnização a cliente, devido a atraso na entrega de encomendas.
- 1.4 Não é possível anulação, de encomendas que contenham produtos denominados especiais, em que, já se tenha iniciado o processo de fabricação.
- 1.5 A mercadoria permanece propriedade da Barros & Moreira, S.A., até à total liquidação da mesma.
- 1.6 Os produtos consideram-se entregues, após a sua descarga e confirmação por parte do cliente, através da sua assinatura no documento que se faz acompanhar. Caso a mercadoria seja entregue por transportadora é necessário, assinalar no talão de carga, todas as evidências físicas de como a mesma foi entregue, para que mais tarde, seja passível de reclamação. Não será considerada qualquer reclamação de "produto danificado por transporte" que não contenha anotação prévia no título de descarga.

2

GARANTIA

- 2.1 Os produtos apresentados neste catálogo têm uma garantia de 3 anos, a partir da data da compra, salvo exceções indicadas e produto específico.

Como por exemplo:

Torneiras : 5 anos (à exceção dos modelos termostáticos e eletrónicos e complementos de torneiras – chuveiros, rampas e colunas de duche, bichas flexíveis, etc., que têm 3 anos)

Autoclismos Interiores: 10 anos (excluem-se desta garantia as peças de desgaste rápido).

- 2.2 As garantias incluem a total ou parcial substituição do produto, em caso de avaria, desde que, esta seja devido a defeito de fabrico. As garantias não cobrem situações decorrentes de utilização negligente, instalação incorreta, manutenção deficiente ou de motivos de causa maior.
- 2.3 O produto defeituoso deverá ser entregue com o certificado que o acompanha, devidamente preenchido, caso contrário considera-se excluída a possibilidade de reparação e/ou reposição do mesmo.
- 2.4 As reclamações devem ser endereçadas à Barros & Moreira por escrito, até a um prazo máximo, de 10 dias, a contar do dia de carga do produto.
- 2.5 Todas as reclamações carecem de análise e aprovação por parte do nosso departamento técnico. No caso de ser emitido um parecer positivo, a Barros & Moreira, será responsável pela reparação do artigo e só em último caso pela reposição de um novo ou do valor pago pelo mesmo.
- 2.6 São possíveis as devoluções de produto, desde que, até 10 dias após a compra e processo previamente aceite pela Barros & Moreira. Não são aceites devoluções de produtos especiais, assim como, produtos já aplicados e/ou danificados. Poderão ser imputados ao cliente custos, processuais, de embalagem e logísticos.

3

JURISDIÇÃO

Em caso de Litígio, o foro competente é o da comarca das Caldas da Rainha.

4

ADVERTÊNCIAS

Reservamo-nos ao direito de proceder a qualquer alteração, sem qualquer aviso prévio, nos preços, materiais e especificações descritas.

As medidas apresentadas são a título orientativo, assim como, as cores apresentadas neste catálogo poderão variar da realidade, devido a variações de impressão.

ctesi



Chegou ao fim?

Vire para continuar a ver!

ctesi

It's about life
and portuguese
bath design.

www.ctesi.pt

ctesi

SOLUÇÕES **TÉCNICAS**

MAR. 2022

www.ctesi.pt

CT.TP.NPT.01