

**ctesi**

**SOLUÇÕES  
técnicas**

**Soluções técnicas**

DESIGNED AND MANUFACTURED IN  
**PORTUGAL**

**25**  
ANOS  
DESDE 1997

[www.ctesi.pt](http://www.ctesi.pt)



## DESENHADO E FABRICADO EM PORTUGAL

A tecnologia evoluiu, os materiais mudaram, mas a base do nosso compromisso manteve-se inalterada: A prestação de um serviço de excelência que prima pela qualidade, funcionalidade dos seus produtos e satisfação dos nossos clientes. Tudo, através da marca portuguesa Ctesi.

A Ctesi é uma das maiores referências do sector e pretende deixar uma marca que perdura pelo futuro.

O investimento na investigação para o desenvolvimento e produção de artigos próprios é o ADN da Ctesi.

Desenvolvemos um sistema de produção onde assumimos controlo sobre todo o processo, acrescentando valor qualitativo a cada uma das etapas da cadeia de produção.



A **Ctesi Technic** é a vertente dos produtos técnicos da **Ctesi**. Estamos vocacionados para a produção e comercialização de todos os tipos de artigos plásticos sanitários, com maior destaque para os autoclismos, válvulas de descarga, torneiras de boia, tampos de sanita, calhas de duche, entre outros. Estes produtos passam por rigorosos testes de qualidade, de modo a garantir um excelente funcionamento, eficiência e durabilidade do material.

Focamo-nos nas necessidades dos técnicos de instalação, mas também na satisfação dos consumidores finais, garantindo produtos de instalação simples e de desempenho eficaz.

Neste variado portefólio de produtos encontramos os autoclismos interiores de simples instalação e fácil acesso e que assumem, de forma natural, um maior protagonismo pela sua combinação de tecnologia eficiente e adaptabilidade.

Encontramos ainda as válvulas de descarga que permitem uma poupança, de até 50%, de água, as torneiras de boia silenciosas e de rápido enchimento, as calhas de duche adaptáveis e que proporcionam uma perfeita drenagem de água.







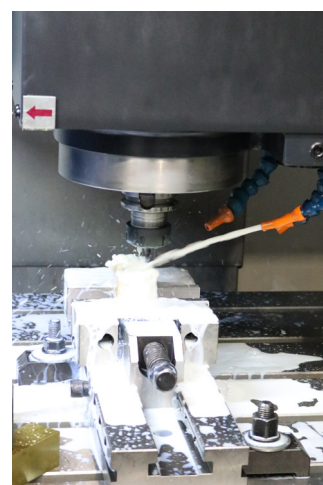



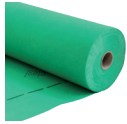

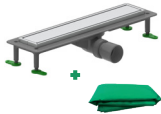

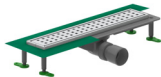





Todos estes produtos são desenvolvidos com os melhores plásticos disponíveis no mercado, sendo escolhidos pela sua elevada qualidade, garantindo uma maior durabilidade e vida útil de cada produto.

Primamos pela produção e comercialização de artigos com elevados padrões de qualidade, que permitam a poupança do mais importante recurso - a água -, criando assim sistemas de verdadeira eficiência hídrica.

Todos os nossos produtos estão conforme as normas e padrões de exigência de qualidade do espaço económico europeu.



## 1 AUTOCLISMOS

			tela impermeabilizante isol	44	
	autoclismos interiores	6		kits calhas de duche	46
	estruturas de instalação	18		calhas de duche	48
	placas de comando	21		sifões de pavimento	52
	autoclismos exteriores	23		válvulas de duche	56
	torneiras de boia	32		duchetas higiénicas	58
	válvulas de descarga	34		tampas para sifão	60
	acessórios autoclismo	36		ventiladores	61
	tubos extensíveis	38		sifões lava-louça	62
	excêntricos sanita	42		acessórios lava-louça	64
	tubos sanita	43		sifões máquina de lavar	65

## 2 TAMPOS DE SANITA

	polipropileno	68		válvulas de banheira	88
	duroplast	69		acessórios para válvulas	88
	duroplast soft close	70		bichas de chuveiro	89
	mdf	73		bichas malha de aço	90
	contraplacado marítimo	77		perlatores	93
	acessórios tampos de sanita	81		acessórios torneiras	96

## 3 ACESSÓRIOS

	torneiras de esquadria	84		acessórios roscar	102
	válvulas de lavatório	86		acessórios cravar	105
	sifões de lavatório	87		acessórios cromados	96
				kit parafusos	112
				<b>CONDIÇÕES GERAIS</b>	113

# 01 autoclismos



EFICIÊNCIA HÍDRICA



DESCARGA DUPLA



SISTEMA START/STOP



ENCAIXE COM ROSCA



ENCAIXE RÁPIDO



ANTI CONDENSAÇÃO



SILENCIOSO



FÁCIL INSTALAÇÃO E MANUTENÇÃO



PROFUNDIDADE



CASQUILHO PLÁSTICO



CASQUILHO LATÃO



ANTI-TORÇÃO



CONFORME CE



UNIVERSAL



SOFT-CLOSE



CAIXA



SACO PLÁSTICO



TAMANHOS PERSONALIZADOS

Ctesi apresenta um conjunto de soluções e novos produtos que assentam num forte compromisso entre a fiabilidade, a eficiência hídrica e o design, de modo a construir uma oferta apelativa que apresentamos nas páginas seguintes.

A gama de autoclismos Ctesi destaca-se pela qualidade dos materiais e durabilidade. Equipamos os nossos produtos com torneiras de boia silenciosas de rápido enchimento e válvulas de descarga desenvolvidas para lhe proporcionar a máxima eficiência hídrica.

Contribuímos para que pequenos gestos façam toda a diferença, poupando no consumo de água sem afetar a eficiência e o conforto no uso deste recurso essencial à vida.







# Simple

É a solução ideal para instalação em paredes resistentes, para fixação de instalações sanitárias ao chão.

Construído com materiais de alta qualidade, as cisternas ocultas simples são robustas e permitem uma economia considerável de espaço.

Equipados com sistema de descarga dupla e torneiras silenciosas, permitem um enchimento rápido e garantem uma rápida instalação, assim como um fácil acesso ao interior através da placa de controle.

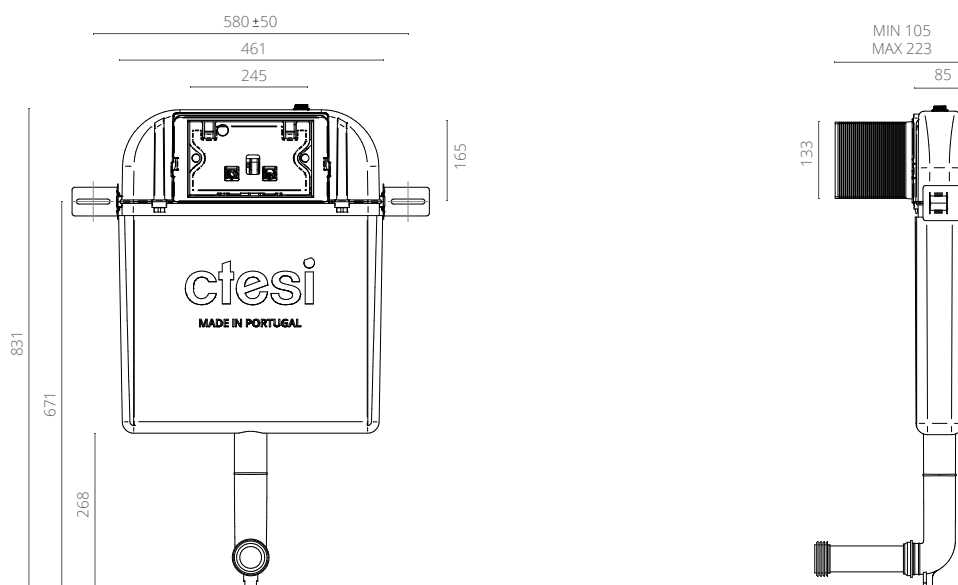
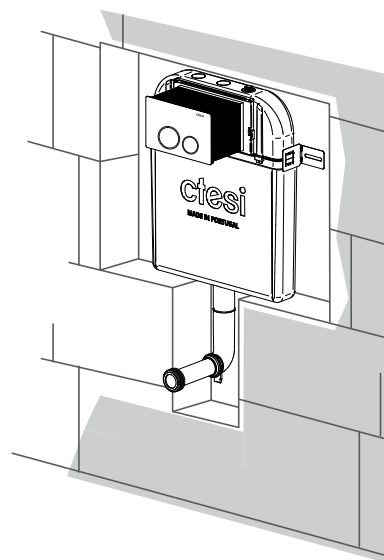

## CARACTERÍSTICAS

- Sem estrutura
- Dupla descarga 3/6l; regulável 3/4,5l
- Isolamento anticondensação e acústico em esferovite com alvéolos
- Torneira de boia silenciosa
- Profundidade 80 mm
- Reservatório em polipropileno (PP) altamente resistente (Temp. água max. 25°C)
- Instalação em paredes de alvenaria
- Marcação CE: EN 14055
- Eficiência energética: classe A
- Compatível com todas as sanitas de fixação ao chão

## INCLUI

- Tubo de descarga
- Tubo de ligação à sanita
- Kit de fixação para alvenaria
- Rede para aplicação em paredes de alvenaria
- Torneira de esquadria G1/2"



## SIMPLE

REF.	DESIGNAÇÃO		
BK0200200	SIMPLES	1	32

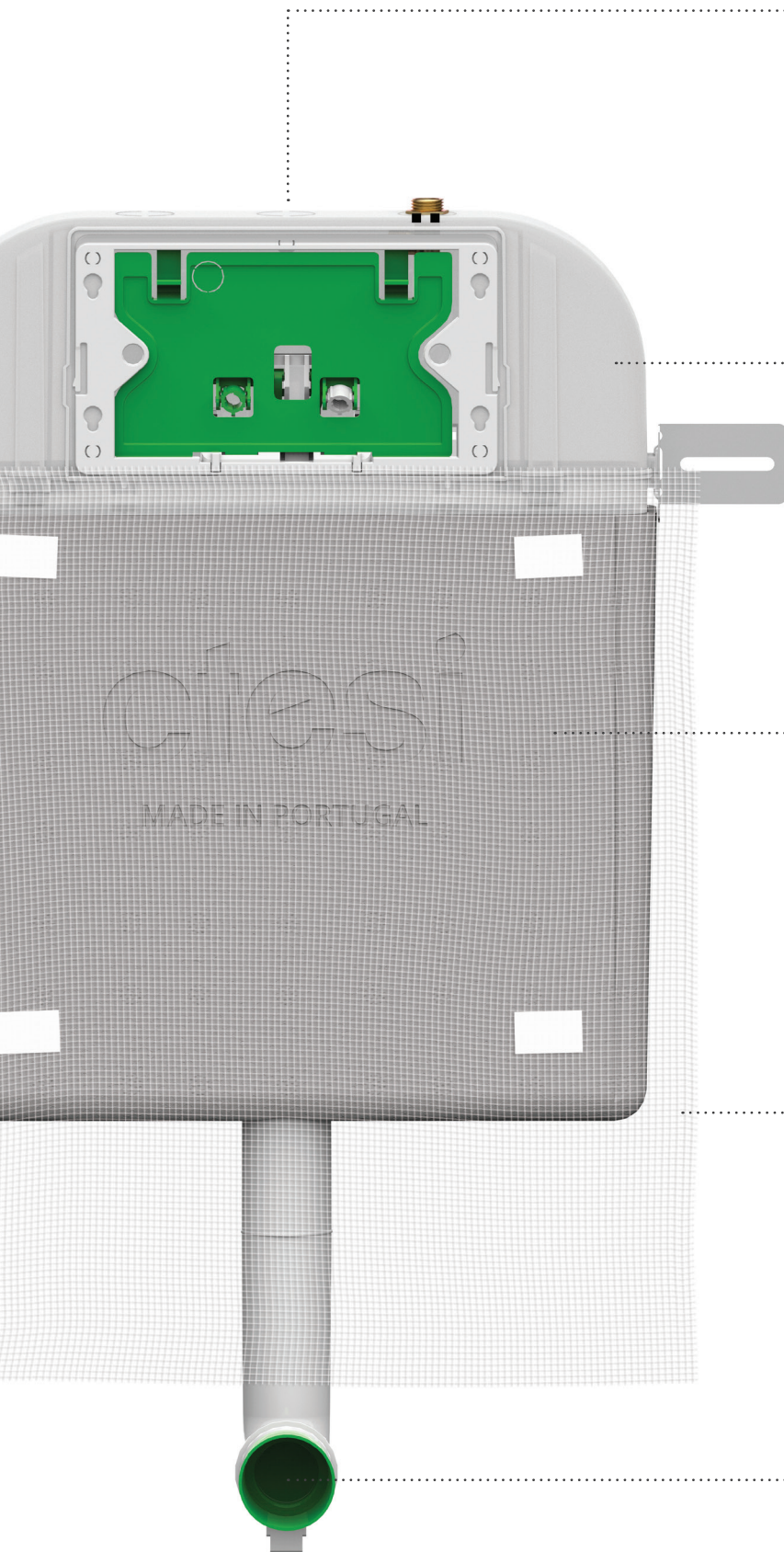

Dupla descarga



Reservatório em polipropileno (PP)  
altamente resistente  
(Temp. água max. 25°C)

Isolamento anticondensação e  
acústico em esferovite com alvéolos

Rede para aplicação em  
paredes de alvenaria

Tubo de ligação à sanita

# Easy

Autoclismo interior da gama de soluções Ctesi®, ideal para a instalação de louças sanitárias em paredes resistentes, tais como paredes de tijolo. Os autoclismos EASY são projetados para aplicação em paredes de alvenaria.

Esta gama de autoclismos permite maior liberdade para criar o seu espaço de banho com mais espaço livre, com forte compromisso entre a confiabilidade, eficiência hídrica e design.

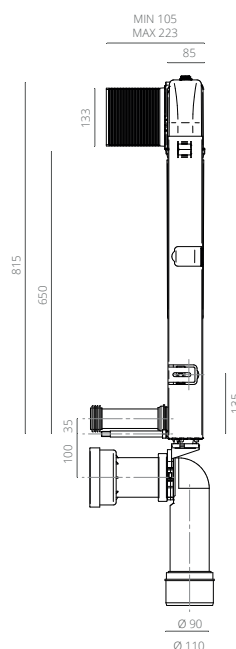
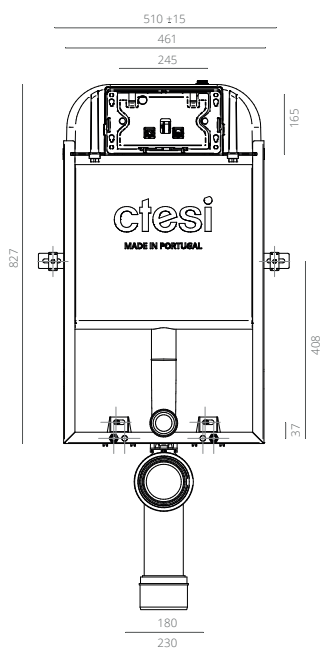
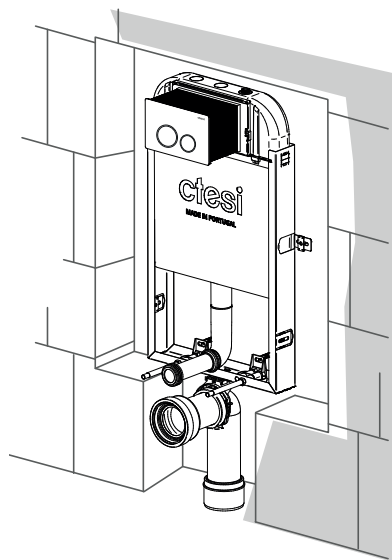

## CARACTERÍSTICAS

- Com estrutura para paredes de alvenaria
- Dupla descarga 3/6l; regulável 3/4,5l
- Isolamento anticondensação e acústico em esferovite com alvéolos
- Torneira de boia silenciosa
- Profundidade 80 mm
- Reservatório em polipropileno (PP) altamente resistente (Temp. água max. 25°C)
- Marcação CE: EN14055
- Eficiência energética: classe A
- Curva de esgoto ajustável em profundidade

## INCLUI

- Tubo de descarga
- Tubo de ligação à sanita
- Kit de fixação de estrutura
- Kit de fixação para louça sanitária
- Rede para aplicação em paredes de alvenaria
- Torneira de esquadria G1/2"
- Curva de esgoto D90/90
- Adaptador D90/110

## EASY

REF.	DESIGNAÇÃO		
BK0200220	COM ESTRUTURA	1	30





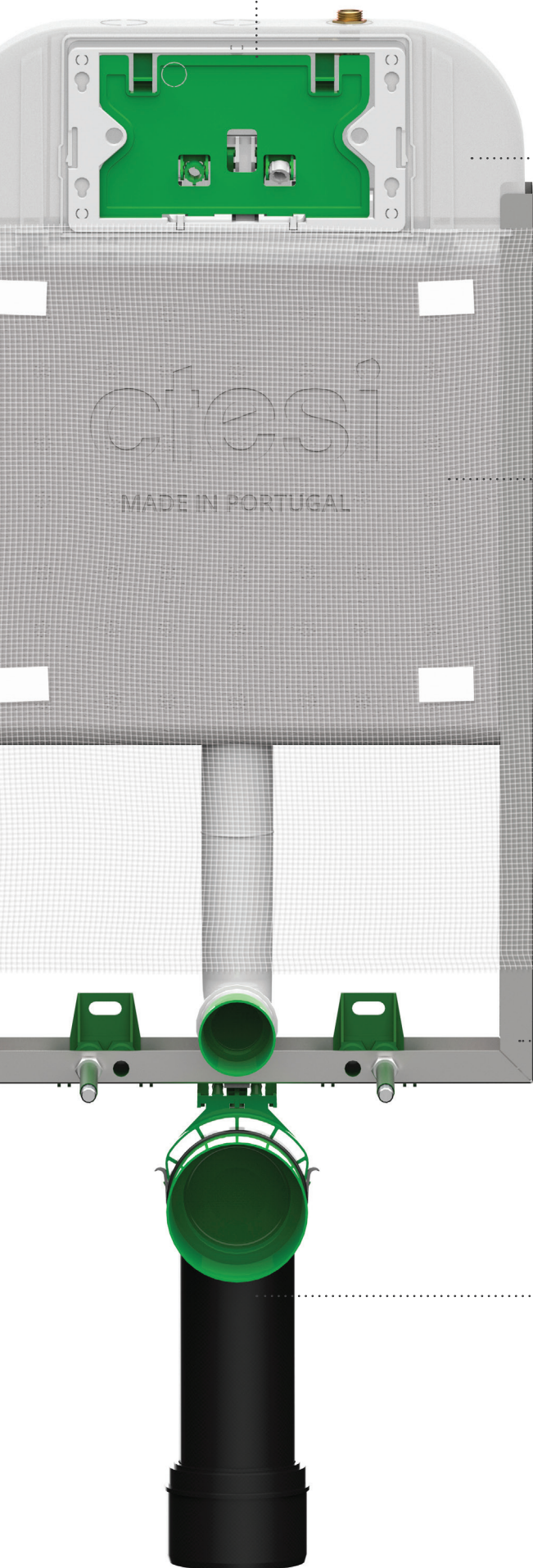

Dupla descarga



Reservatório em polipropileno (PP) altamente resistente (Temp. água max. 25°C)

Isolamento anticondensação e acústico em esferovite com alvéolos

Rede para aplicação em paredes de alvenaria

Com estrutura para paredes de alvenaria

Curva de esgoto ajustável em profundidade

# Easy com pés

Autoclismo interior da gama de soluções Ctesi®, ideal para a instalação de louças sanitárias em paredes resistentes, tais como paredes de tijolo. Os autoclismos EASY são projetados para aplicação em paredes de alvenaria.

Os pés em aço galvanizado permitem auxiliar a montagem da estrutura EASY para aplicação de louça suspensa. Os pés Easy permitem ajustar a altura de fixação da estrutura Easy com autoclismo interior, conferindo uma maior resistência à estrutura enquanto contribuem para uma instalação mais fácil e nivelamento do autoclismo interior com estrutura Easy.

Estruturas galvanizadas para encastrar em paredes de alvenaria, para instalação de louças sanitárias suspensas. Posição da curva de esgoto regulável em profundidade.

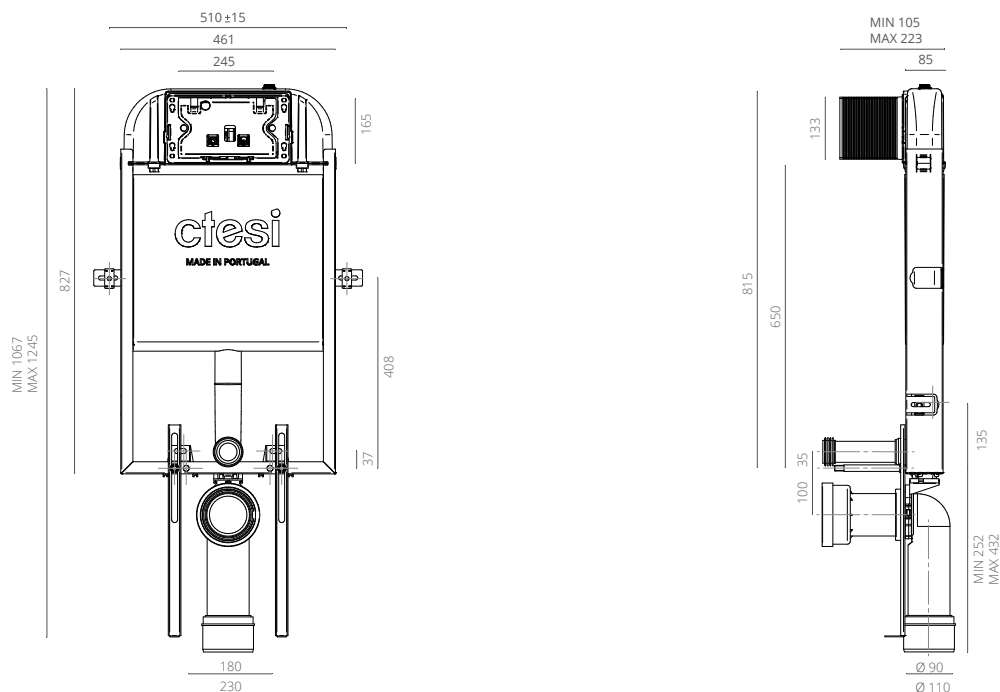
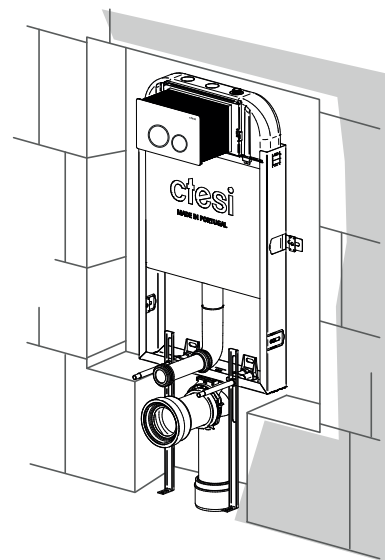

## CARACTERÍSTICAS

- Com estrutura para paredes de alvenaria
- Com pés ajustáveis
- Dupla descarga 3/6l; regulável 3/4,5l
- Isolamento anticondensação e acústico em esferovite com alvéolos
- Torneira de boia silenciosa
- Profundidade 80 mm
- Reservatório em polipropileno (PP) altamente resistente (Temp. água máx. 25°C)
- Marcação CE: EN 14055
- Eficiência energética: classe A
- Curva de esgoto ajustável em profundidade

## INCLUI

- Tubo de descarga
- Tubo de ligação à sanita
- Kit de fixação da estrutura
- Kit Fixação para louça sanitária
- Rede para aplicação em paredes de alvenaria
- Torneira de esquadria G1/2"
- Curva de esgoto D90/90
- Adaptador D90/110

## EASY COM PÉS

REF.	DESIGNAÇÃO		
BK0200221	COM ESTRUTURA E PÉS	1	30





Dupla descarga



Reservatório em polipropileno (PP)  
altamente resistente  
(Temp. água max. 25°C)

Isolamento anticondensação e  
acústico em esferovite com alvéolos

Rede para aplicação em  
paredes de alvenaria

Com estrutura para  
paredes de alvenaria

Curva de esgoto ajustável  
em profundidade

Com pés ajustáveis

# Solid

Solid é um sistema de instalação com alta resistência mecânica para a instalação de louças sanitárias em paredes de gesso, ideal para novas construções ou remodelações.

Estrutura metálica de fixação à parede e ao chão, regulável em altura para instalação de louças sanitárias suspensas. Aplicação em paredes de alvenaria, paredes ligeiras ou calha técnica. Posição da curva de esgoto regulável em profundidade.

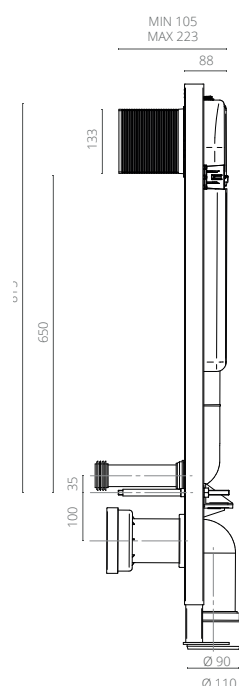
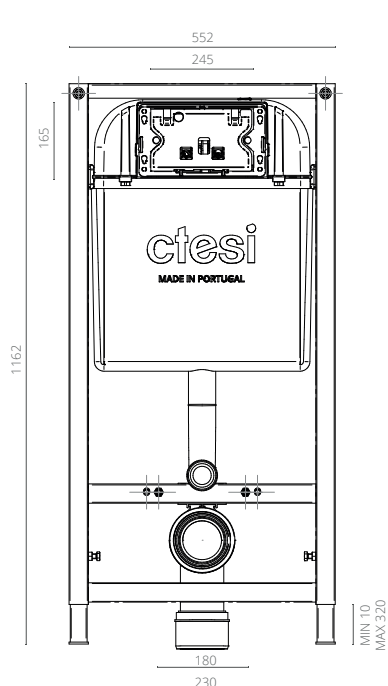
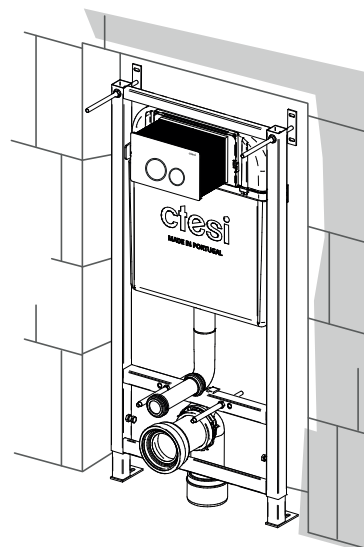

## CARACTERÍSTICAS

- Com estrutura para paredes de alvenaria, paredes ligeiras ou calha técnica
- Dupla descarga 3/6l; regulável 3/4,5l
- Isolamento anticondensação e acústico em esferovite com alvéolos
- Torneira de boia silenciosa
- Profundidade 80 mm
- Suporta até 400 Kg
- Reservatório em polipropileno (PP) altamente resistente (Temp. água máx. 25°C)
- Marcação CE: EN 14055
- Eficiência energética: classe A
- Curva de esgoto ajustável em profundidade
- Altura regulável de 0-300 mm

## INCLUI

- Tubo de descarga
- Tubo de ligação à sanita
- Kit de fixação da estrutura
- Kit Fixação para louça sanitária
- Torneira de esquadria G1/2"
- Curva de esgoto D90/90
- Adaptador D90/110

## SOLID

REF.	DESIGNAÇÃO		
BK0200240	COM ESTRUTURA	1	15







Suporta até 400 Kg



Dupla descarga



Reservatório em polipropileno (PP)  
altamente resistente  
(Temp. água max. 25°C)

Isolamento anticondensação e  
acústico em esferovite com alvéolos

Com estrutura para paredes  
de alvenaria, paredes ligeiras  
ou calha técnica

Curva de esgoto ajustável  
em profundidade

Altura regulável de 0-300 mm



# Self simples

O SELF SIMPLES foi concebido para simplificar - para instaladores e consumidores finais - todo o processo de instalação e utilização. Simples no processo, eficiente na tecnologia. É o sistema ideal para a instalação de louça sanitária suspensa em paredes ligeiras, permitindo uma real economia de espaço.

O design inteligente, adaptado e seguro, garante uma instalação rápida através da sua estrutura com sistema de fixação ao chão. O isolamento anti condensação evita a acumulação de águas e o isolamento acústico garante-lhe um sistema silencioso.

É um sistema adaptável que lhe permite regular, a altura entre os 0-300mm, o sistema de dupla descarga ou mesmo a posição da curva de esgoto.

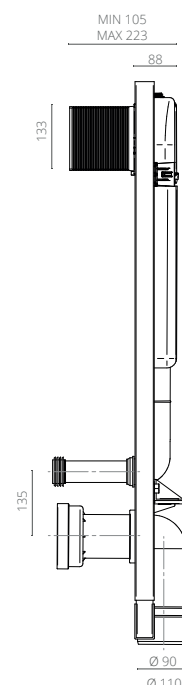
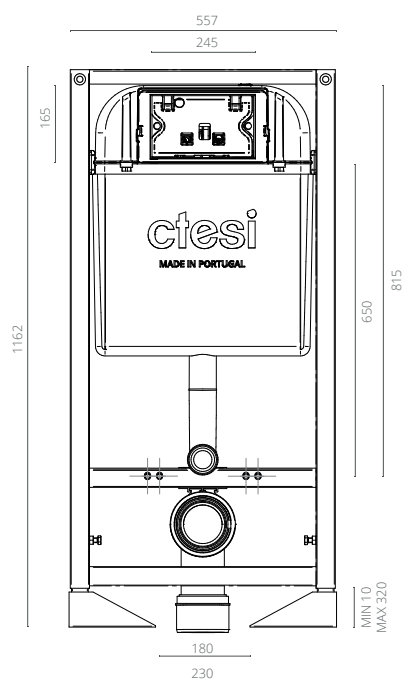
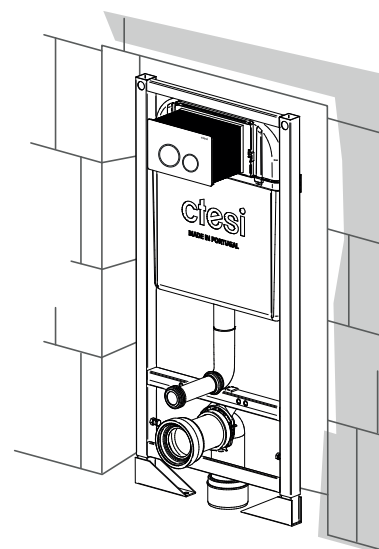

## CARACTERÍSTICAS

- Com estrutura para fixação ao chão em paredes ligeiras
- Dupla descarga 3/6l; regulável 3/4,5l
- Isolamento anticondensação e acústico em esferovite com alvéolos
- Torneira de boia silenciosa
- Profundidade 80 mm
- Suporta até 400kg
- Reservatório em polipropileno (PP) altamente resistente (Temp. água máx. 25°C)
- Marcação CE: EN 14055
- Eficiência energética: classe A
- Curva de esgoto ajustável em profundidade
- Altura regulável de 0-300 mm

## INCLUI

- Tubo de descarga
- Tubo de ligação à sanita
- Kit de fixação da estrutura
- Kit Fixação para louça sanitária
- Torneira de esquadria G1/2"
- Curva de esgoto D90/90
- Adaptador D90/110



## SELF SIMPLES

REF.	DESIGNAÇÃO		
BK0200260	COM ESTRUTURA	1	15



Suporta até 400 Kg



Dupla descarga



Reservatório em polipropileno (PP)  
altamente resistente  
(Temp. água max. 25°C)

Isolamento anticondensação e  
acústico em esferovite com alvéolos

Com estrutura para paredes  
de alvenaria, paredes ligeiras  
ou calha técnica

Curva de esgoto ajustável  
em profundidade

Altura regulável de 0-300 mm



# Self duplo

Um único sistema para duas sanitas diferentes. SELF DUPLO é a escolha acertada na instalação de louças sanitárias suspensas “costas com costas” na mesma parede. Indicado para paredes ligeiras, combina a mais recente tecnologia sanitária com a eficiência de uso e simplicidade de instalação.

Permite uma instalação rápida devido ao seu design inteligente, funcional e seguro através da sua estrutura com sistema de fixação ao chão. O isolamento anti condensação evita a acumulação de águas, e o isolamento acústico, e garante-lhe um real sistema silencioso.

Permite-lhe regular a altura entre os 0-300mm, o sistema de dupla descarga ou mesmo a posição da curva de esgoto.

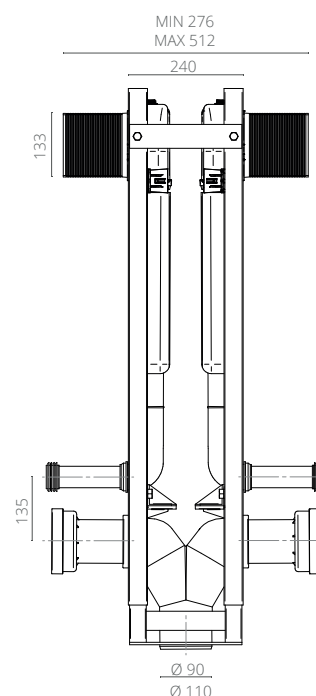
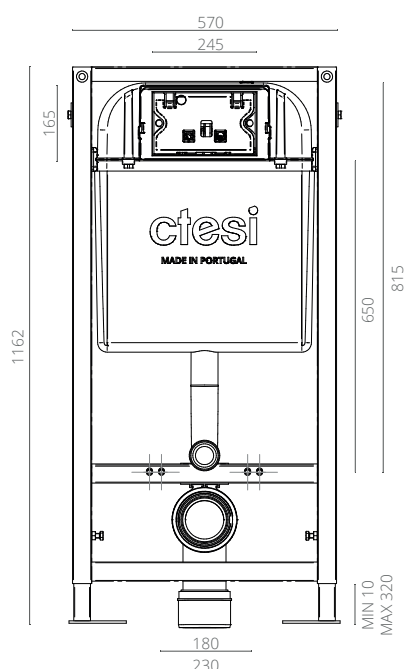
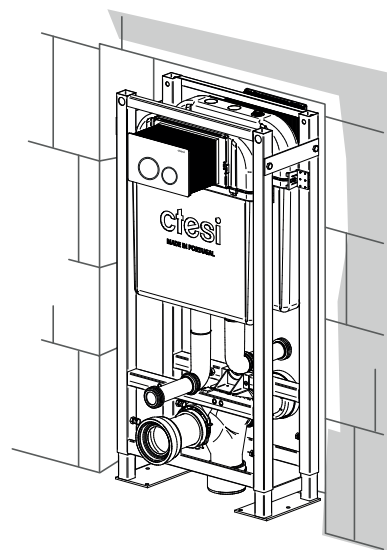

## CARACTERÍSTICAS

- Com estrutura para fixação ao chão em paredes ligeiras
- Estrutura metálica para aplicação de 2 sanitas suspensas “costas com costas”
- Dupla descarga 3/6l; regulável 3/4,5l
- Isolamento anticondensação e acústico em esferovite com alvéolos
- Torneira de boia silenciosa
- Profundidade 80 mm
- Suporta 400 kg
- Reservatório em polipropileno (PP) altamente resistente (Temp. água máx. 25°C)
- Marcação CE: EN 14055
- Eficiência energética: classe A
- Curva de esgoto ajustável em profundidade
- Altura regulável de 0-300 mm

## INCLUI

- Tubo de descarga
- Tubo de ligação à sanita
- Kit de fixação da estrutura
- Kit Fixação para louça sanitária
- Torneira de esquadria G1/2"
- Curva de esgoto em “Y” D90
- Adaptador D90/110

## SELF DUPLO

REF.	DESIGNAÇÃO		
BK0200261	COM ESTRUTURA E PÉS	1	15







Suporta até 400 Kg



Dupla descarga



Reservatório em polipropileno (PP)  
altamente resistente  
(Temp. água max. 25°C)

Isolamento anticondensação e  
acústico em esferovite com alvéolos

Estrutura metálica para  
aplicação de 2 sanitas suspensas  
"costas com costas"

Com estrutura para paredes  
de alvenaria, paredes ligeiras  
ou calha técnica

Curva de esgoto ajustável  
em profundidade

Altura regulável de 0-300 mm



# Estruturas de instalação

Com a gama de soluções para estruturas sanitárias embutidas Ctesi® tem toda a liberdade para criar o seu espaço de banho com mais espaço livre, num forte compromisso entre a fiabilidade, a eficiência hídrica e o design.

Toda a gama foi desenvolvida para oferecer a melhor prestação em utilizações intensivas, quer seja para espaços públicos ou privados.

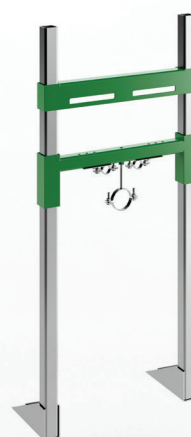

- Estrutura metálica para lavatório suspenso
- Fixação à parede ou ao chão (em paredes ligeiras)
- Fácil instalação e manutenção
- Altura ajustável
- Suporta até 150 kg

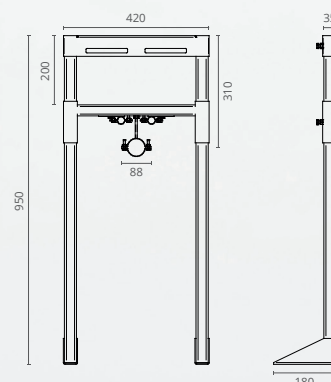

## SET



REF.	DESIGNAÇÃO		
BK0204020	ESTRUTURA LAVATÓRIO	1	60

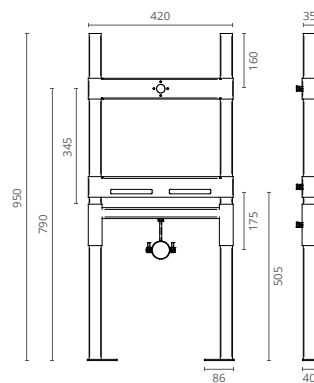

- Estrutura metálica para urinol
- Fixação à parede e ao chão
- Fácil instalação e manutenção
- Altura ajustável
- Suporta até 150 kg



## RIG

REF.	DESIGNAÇÃO		
BK0204030	ESTRUTURA URINOL	1	60

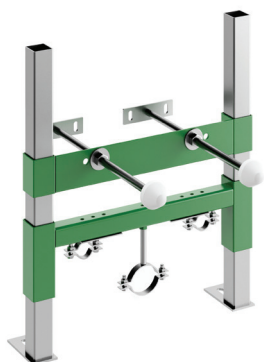

- Estrutura metálica para bidé
- Fixação à parede e ao chão
- Fácil instalação e manutenção
- Altura ajustável
- Suporta até 400 kg

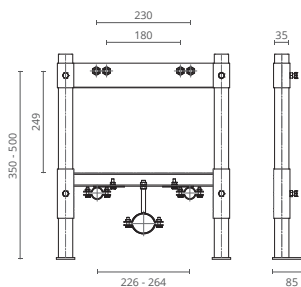

## LEAD

REF.	DESIGNAÇÃO		
BK0204010	ESTRUTURA DE BIDÉ	1	80



- Estrutura metálica para bidé
- Fácil instalação e manutenção
- Altura ajustável
- Suporta até 400 kg

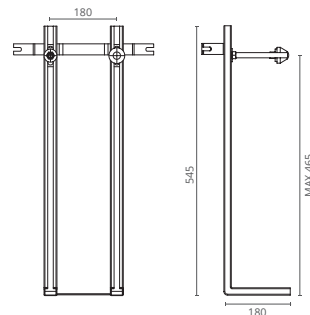

## LIGHT

REF.	DESIGNAÇÃO		
BK0204100	ESTRUTURA DE BIDÉ	1	100





**Placas de comando**



## PVD

CROMADO MATE BRANCO PRETO GRAFITE OURO BRONZE

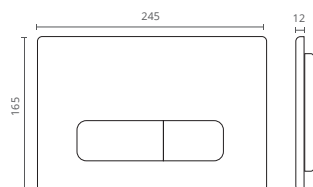

## KEEN

REF.	COR / ACABAMENTO			
BK0202100	CROMADO	1	22	616
BK0202103	MATE	1	22	616
BK0202101	BRANCO	1	22	616
BK0202102	PRETO	1	22	616
BK0202107	GRAFITE	1	22	616
BK0202108	OURO	1	22	616
BK0202109	BRONZE	1	22	616



## PVD

CROMADO MATE BRANCO PRETO GRAFITE OURO BRONZE

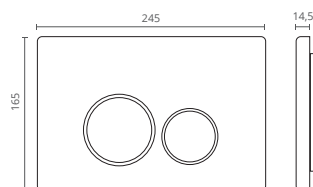

## ROUND

REF.	COR / ACABAMENTO			
BK0202120	CROMADO	1	22	616
BK0202123	MATE	1	22	616
BK0202121	BRANCO	1	22	616
BK0202122	PRETO	1	22	616
BK0202127	GRAFITE	1	22	616
BK0202128	OURO	1	22	616
BK0202129	BRONZE	1	22	616

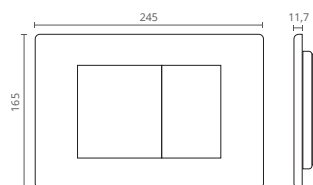
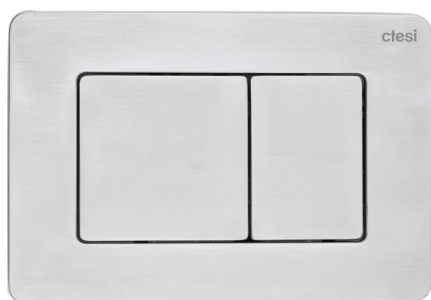

## STEEL

REF.	COR / ACABAMENTO			
BK0202140	AÇO INOX - ESCOVADO	1	22	616



# Autoclismos exteriores

## Tipos de aplicação

**A**

### Monobloco

Para aplicação acoplada diretamente sobre a sanita.  
Ideal para a substituição de autoclismos cerâmicos.

**B**

### Mochila

Para aplicação com fixação na parede, fornecido com tubo de descarga para ligação e limpeza da sanita.

**C**

### Alto

Para aplicação com fixação em posição alta na parede, fornecido com tubo de descarga até 1,60m de altura e puxador para accionamento da descarga para a limpeza de sanitas ou sanitas turcas.



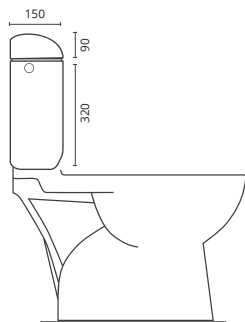
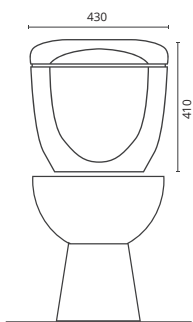

## CARACTERÍSTICAS

- Descarga dupla (3/6 litros)
- Fácil regulação do volume de descarga máxima até 9 litros
- Sistema de montagem para instalação acoplada à sanita
- Entrada de água lateral (esquerda/direita) ou inferior e posterior
- Isolamento anti-condensação e acústico
- Fácil instalação e manutenção
- Inclui todos os acessórios necessários para instalação
- Válvula de descarga com vedante em silicone
- Fornecido em embalagem individual
- Em conformidade com a norma europeia (EN14055)

REF.	COR - MODELO			
BK0010500	BRANCO - ENTRADA LATERAL 3/8"	1	4	80
BK0010501	BRANCO - ENTRADA INFERIOR 3/8"	1	4	80

# Bahia Duo

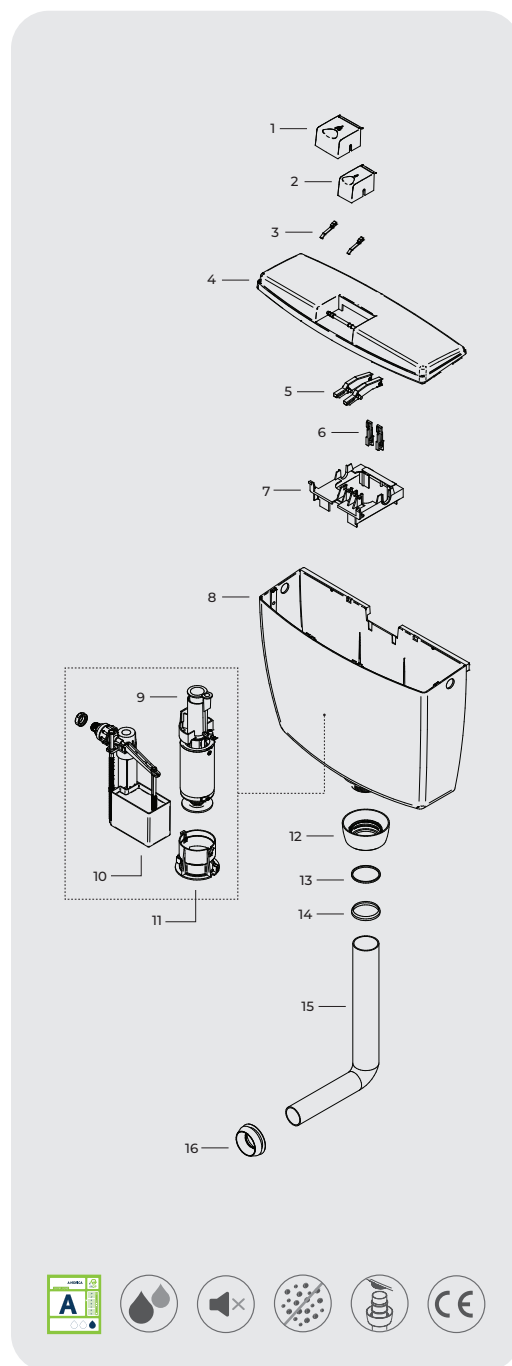
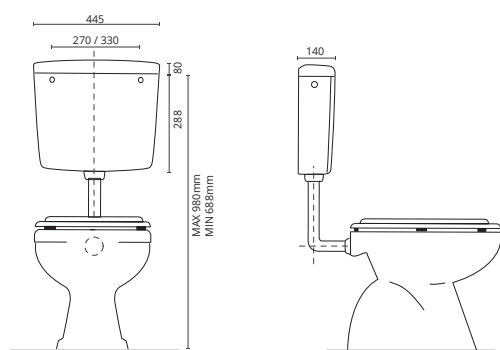

## CARACTERÍSTICAS

- Descarga dupla (3/6 litros)
- Fácil regulação do volume de descarga máxima até 9 litros
- Entrada de água lateral (esquerda/direita) e posterior
- Isolamento anti-condensação e acústico
- Fácil instalação e manutenção
- Inclui todos os acessórios necessários para instalação

- Válvula de descarga com vedante em silicone
- Com tubo de descarga Ø50 x Ø40 x 325 mm
- Fornecido em embalagem individual
- Em conformidade com a norma europeia (EN14055)
- Curva de esgoto ajustável em profundidade
- Altura regulável de 0-300 mm

REF.

COR - MODELO

BK0010100

BRANCO - 3/8"



1

5

100



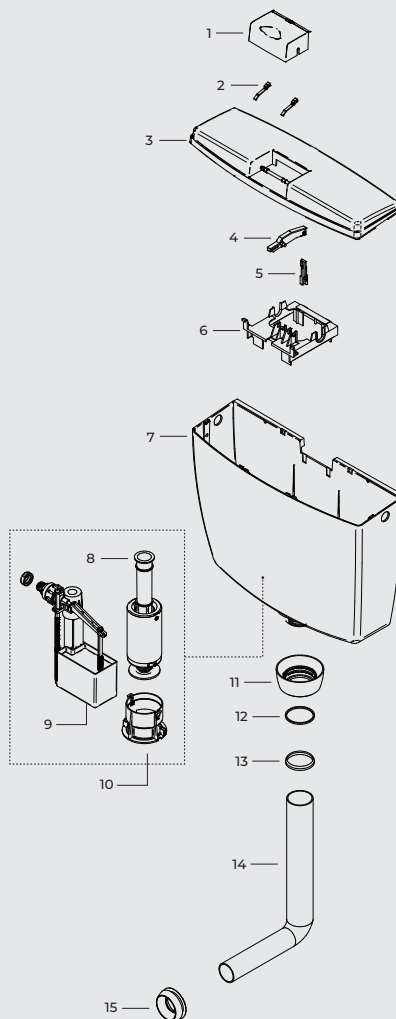
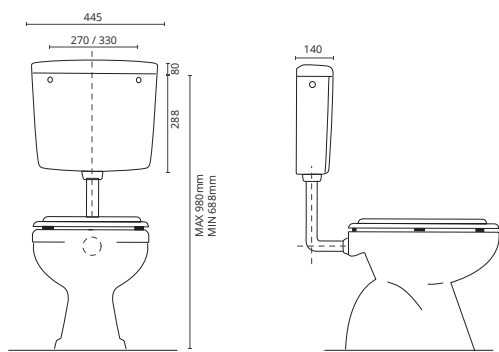

## CARACTERÍSTICAS

- Descarga interrompível (até 6 litros)
- Fácil regulação do volume de descarga máxima entre 6l e 9l
- Entrada de água lateral (esquerda/direita) e posterior
- Isolamento anti-condensação e acústico
- Fácil instalação e manutenção

- Inclui todos os acessórios necessários para instalação
- Válvula de descarga com vedante em silicone
- Com tubo de descarga  $\varnothing 50 \times \varnothing 40 \times 325$  mm
- Fornecido em embalagem individual
- Em conformidade com a norma europeia (EN14055)

REF.

COR - MODELO

1

5

100

BK0000400

BRANCO - 3/8"

1

5

100

## Iara Duo

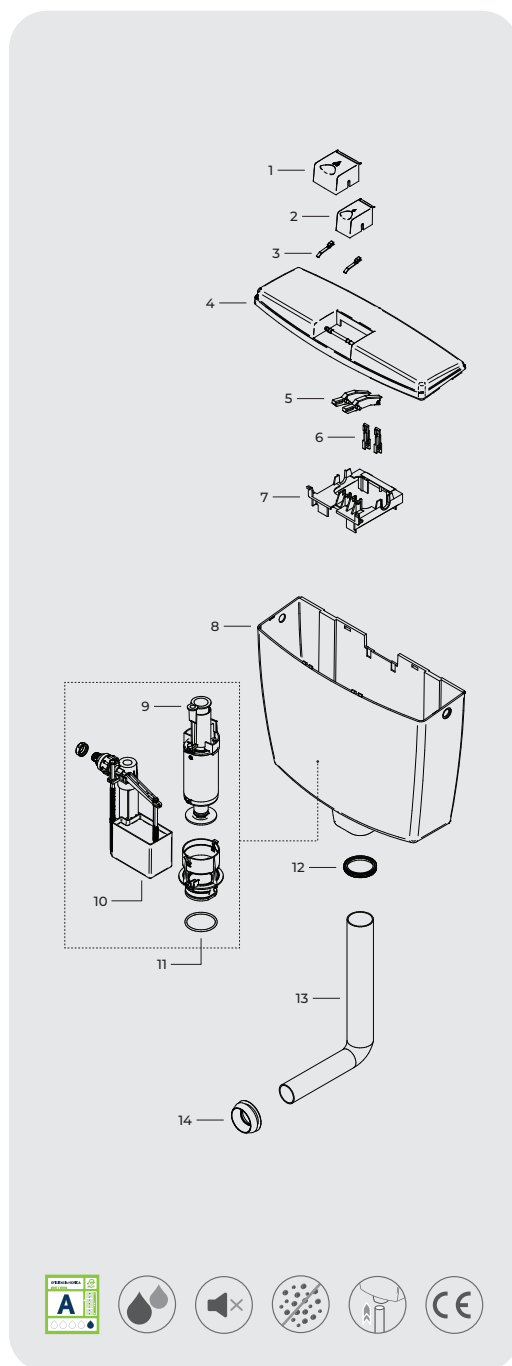
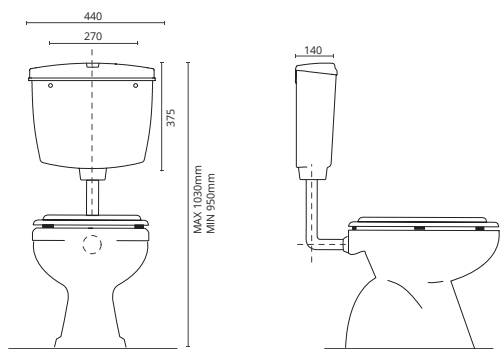

## CARACTERÍSTICAS

- Descarga dupla (3/6 litros)
- Fácil regulação do volume de descarga máxima até 9l
- Sistema de encaixe rápido do tubo de descarga
- Entrada de água lateral (esquerda/direita) e posterior
- Isolamento anti-condensação e acústico
- Fácil instalação e manutenção
- Inclui todos os acessórios necessários para instalação
- Válvula de descarga com vedante em silicone
- Com tubo de descarga Ø50 x Ø40 x 325 mm
- Fornecido em embalagem individual
- Em conformidade com a norma europeia (EN14055)

REF.	COR - MODELO	CORES DISPONÍVEIS			
BK0010000	BRANCO - 3/8"		1	5	100
BK0010001	CINZENTO - 3/8"		1	5	100
BK0010002	PERGAMÓN - 3/8"		1	5	100
BK0010003	ROSA - 3/8"		1	5	100

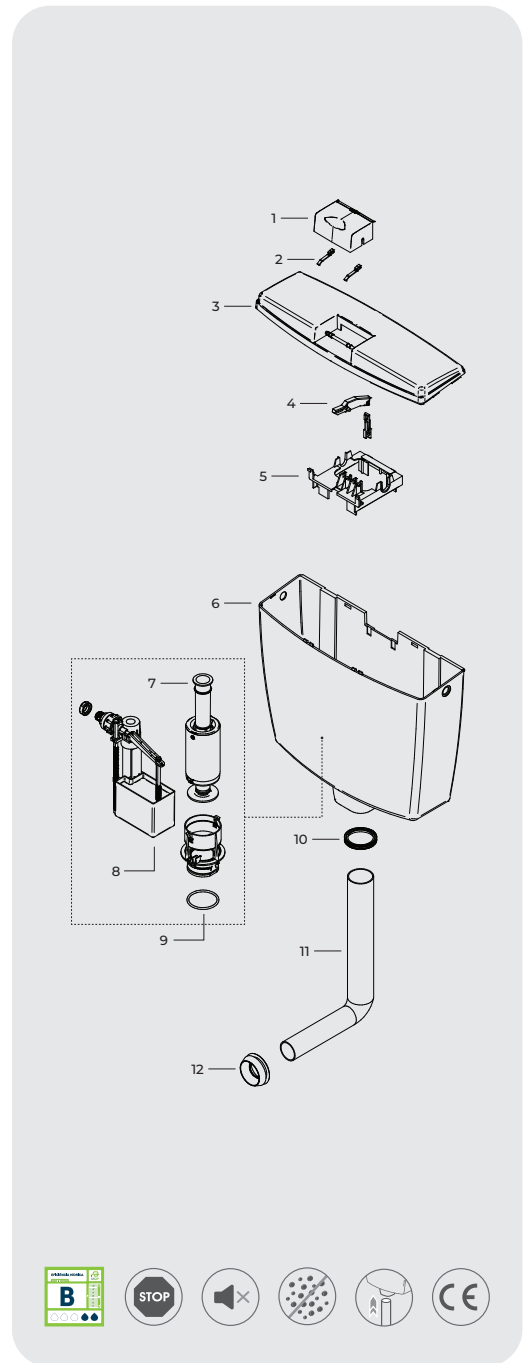
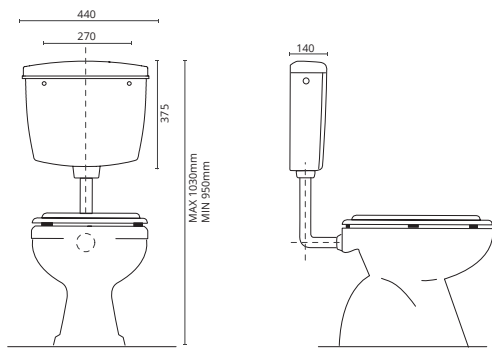

## CARACTERÍSTICAS

- Descarga interrompível (até 6 litros)
- Fácil regulação do volume de descarga máxima entre 6l e 9l
- Sistema de encaixe rápido do tubo de descarga
- Entrada de água lateral (esquerda/direita) e posterior
- Isolamento anti-condensação e acústico
- Fácil instalação e manutenção
- Inclui todos os acessórios necessários para instalação
- Válvula de descarga com vedante em silicone
- Com tubo de descarga Ø50 x Ø40 x 325 mm
- Fornecido em embalagem individual
- Em conformidade com a norma europeia (EN14055)

REF.

COR - MODELO



BK0000300

BRANCO - 3/8"

1

5

100

# Sampi

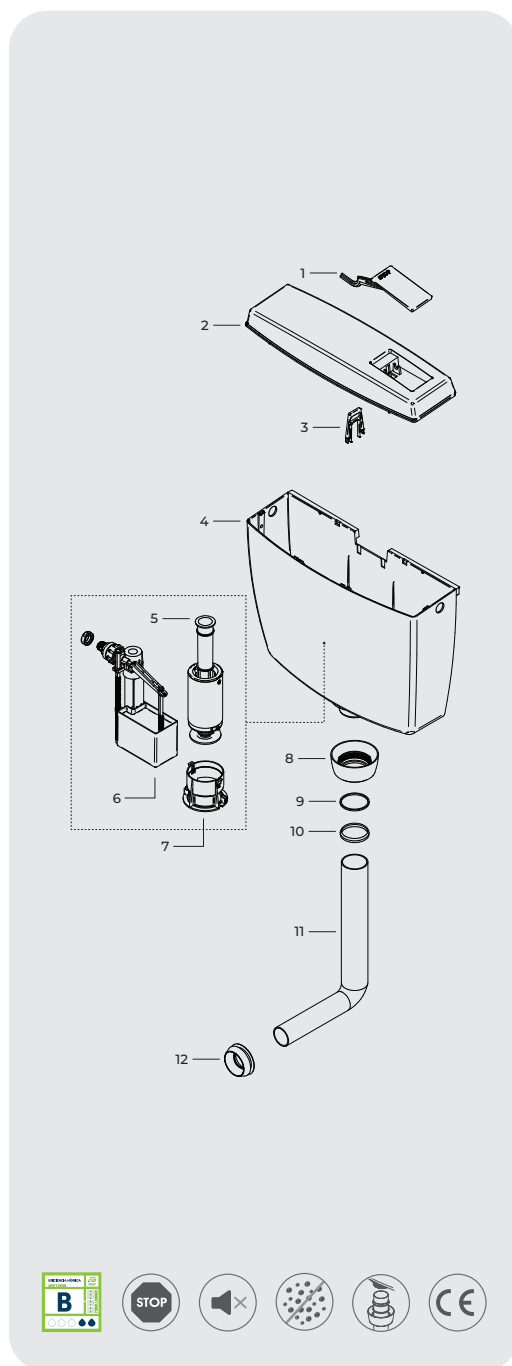
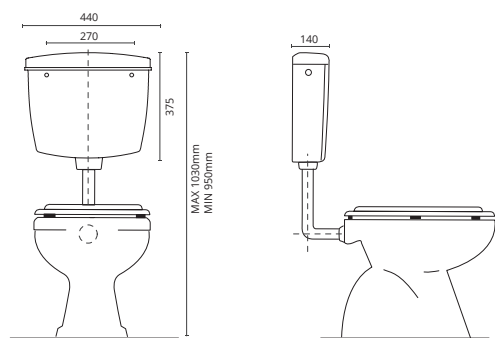

## CARACTERÍSTICAS

- Descarga interrompível (até 6 litros)
- Fácil regulação do volume de descarga máxima entre 6l e 9l
- Montagem rápida
- Entrada de água lateral (esquerda/direita) e posterior
- Isolamento anti-condensação e acústico
- Fácil instalação e manutenção

- Inclui todos os acessórios necessários para instalação
- Válvula de descarga com vedante em silicone
- Com tubo descarga Ø50 x Ø40 x 325 mm
- Fornecido em embalagem individual
- Em conformidade com a norma europeia (EN14055)

REF.

BK0000200

COR - MODELO

BRANCO - 3/8"

1

5

100

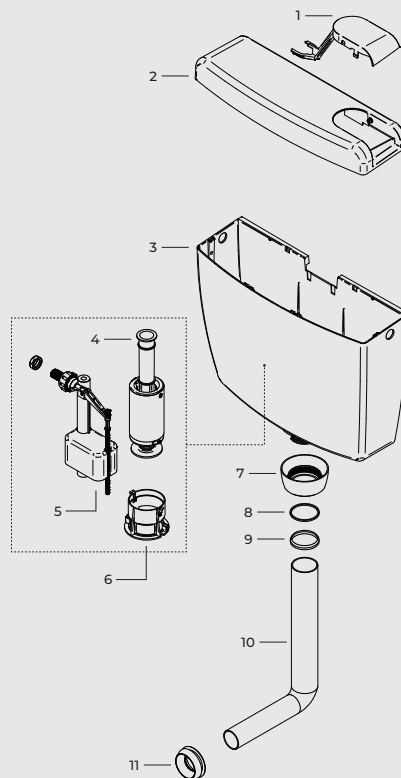
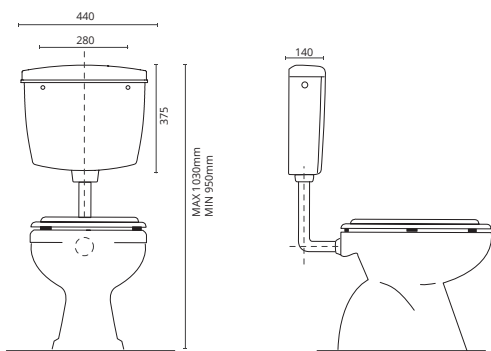

## CARACTERÍSTICAS

- Descarga interrompível (até 6 litros)
- Fácil regulação do volume de descarga máxima entre 6l e 9l
- Entrada de água lateral (esquerda/direita) e posterior
- Fácil instalação e manutenção
- Inclui todos os acessórios necessários para instalação

- Válvula de descarga com vedante em silicone
- Com tubo de descarga Ø50 x Ø40 x 325 mm
- Fornecido em embalagem individual
- Em conformidade com a norma europeia (EN14055)

REF.

COR - MODELO

1

5

100

BK0000100

BRANCO - 3/8"

1

5

100

# loca

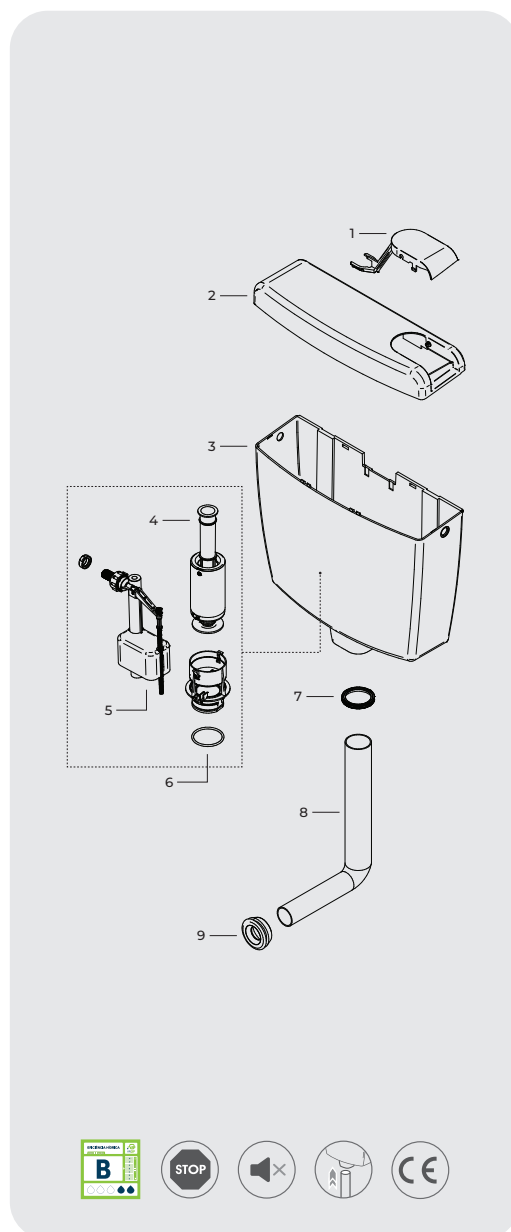
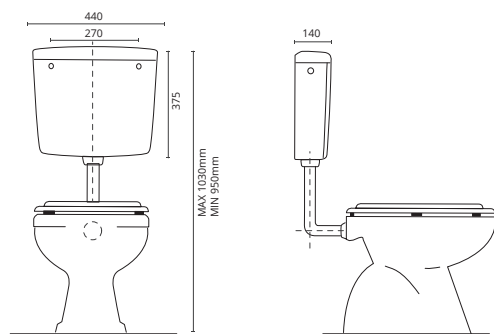

## CARACTERÍSTICAS

- Descarga interrompível (até 6 litros)
- Fácil regulação do volume de descarga máxima entre 6l e 9l
- Sistema de encaixe rápido do tubo de descarga
- Entrada de água lateral (esquerda/direita) e posterior
- Fácil instalação e manutenção

- Inclui todos os acessórios necessários para instalação
- Válvula de descarga com vedante em silicone
- Com tubo de descarga Ø50 x Ø40 x 325 mm
- Fornecido em embalagem individual
- Em conformidade com a norma europeia (EN 14055)

REF.

COR - MODELO



BK0000001

BRANCO - 3/8"

1

5

100

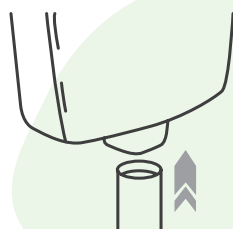

## ENCAIXE RÁPIDO

O sistema de encaixe rápido do tubo de descarga que equipa os modelos lara e loca, permitem-lhe uma rápida fixação do tubo de descarga sem o recurso a quaisquer tipo de ferramentas ou vedações enquanto lhe garantem uma perfeita vedação nesta ligação.



# Trópico Alto

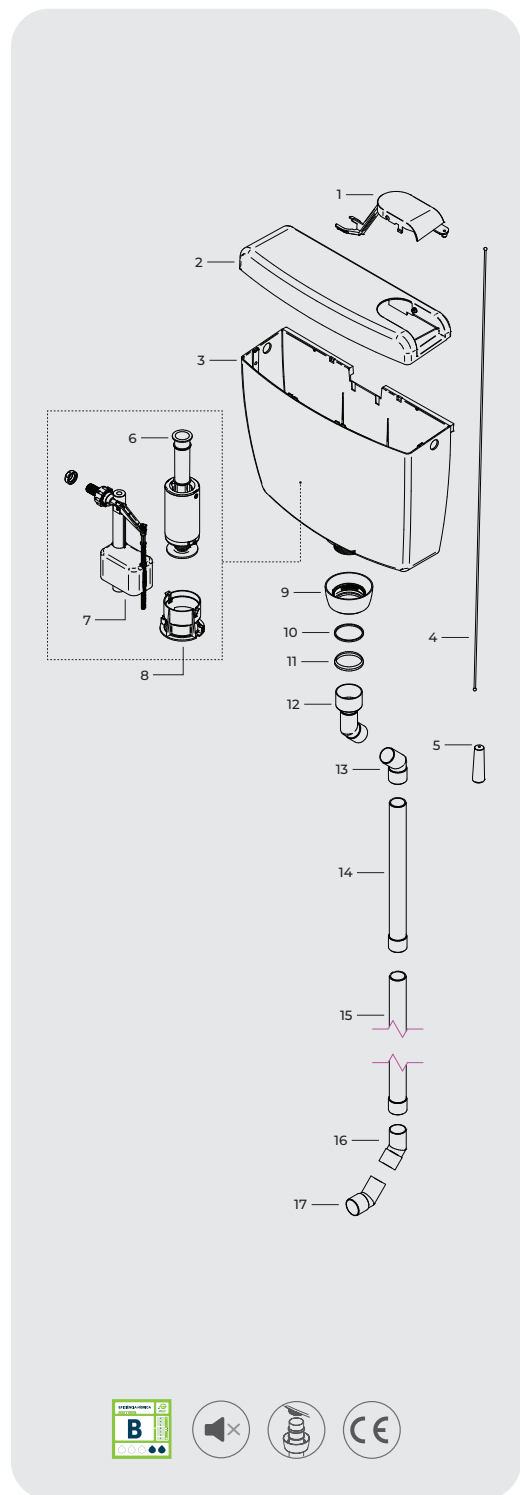
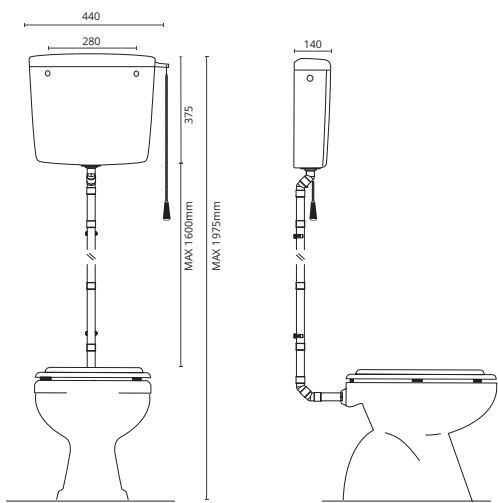

## CARACTERÍSTICAS

- Descarga interrompível (até 6 litros)
- Fácil regulação do volume de descarga máxima entre 6l e 9l
- Sistema de encaixe rápido do tubo de descarga
- Entrada de água lateral (esquerda/direita) e posterior
- Fácil instalação e manutenção

- Inclui todos os acessórios necessários para instalação
- Válvula de descarga com vedante em silicone
- Fornecido com kit de tubos de descarga: 4 tubos - Ø50 x Ø32,5 x 400 mm
- Fornecido em embalagem individual
- Em conformidade com a norma europeia (EN14055)

REF.

COR - MODELO



BK0000150

BRANCO - COM TUBO - 3/8"

1

5

100

# Kombi

Fecho rápido e eficaz

Fácil ajuste da boia em altura

Fácil regulação

Tubo Telescópico para fácil ajuste em altura

Casquilho em latão 3/8"

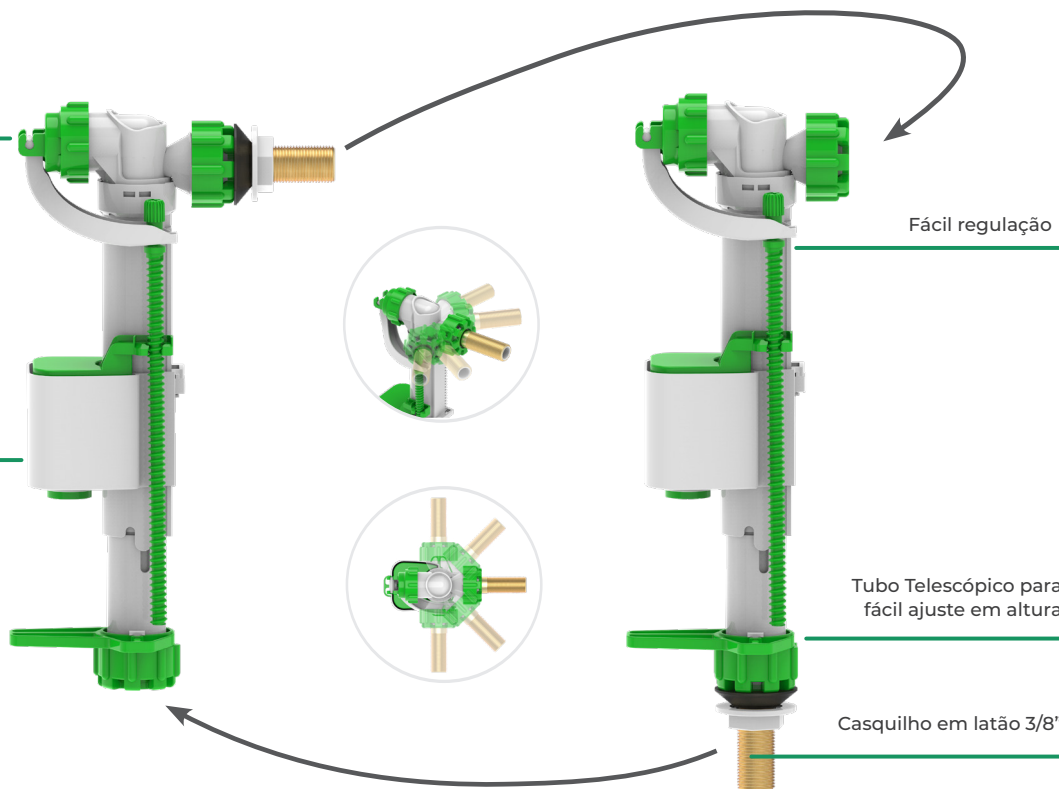

## 2 em 1

Entrada inferior ou entrada lateral

## Compacta

Ideal para autoclismos de dimensões reduzidas

## Universal

Adapta-se facilmente a todos os autoclismo cerâmicos

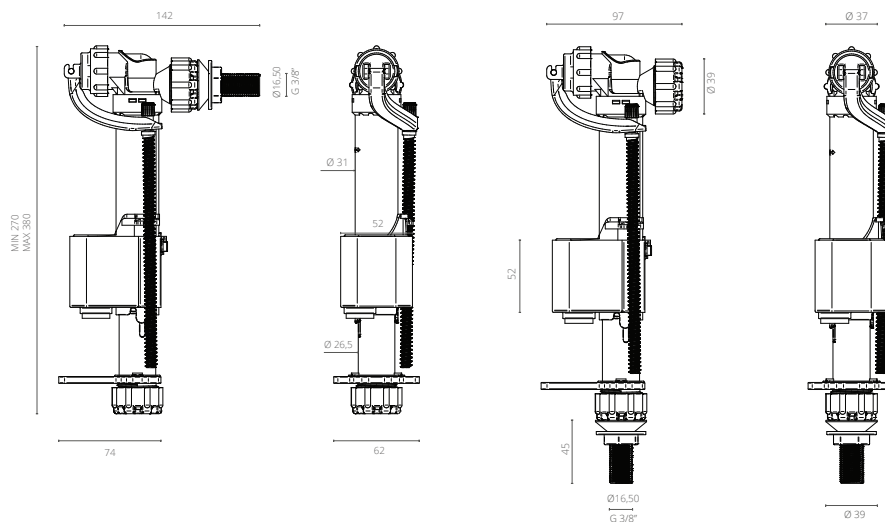

## CARACTERÍSTICAS

- Fácil ajuste em altura
- Entrada lateral orientável a 180°
- Enchimento rápido e silencioso
- Excelente desempenho com qualquer pressão de rede
- Sistema de entrada de água ultra-silencioso
- Casquilho em latão
- Fácil adaptação para torneira de boia de entrada de água lateral ou inferior

REF.

BK0402000

MEDIDAS

3/8" -

5

20



# Kompact

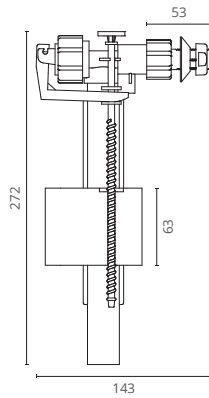

- Fácil ajuste em altura
- Entrada lateral orientável a 180°
- Enchimento rápido e silencioso
- Excelente desempenho com qualquer pressão de rede
- Sistema de entrada de água ultra-silencioso
- Casquilho em latão

REF.	MEDIDAS			
BK0400100	3/8" -	5	20	

# Top

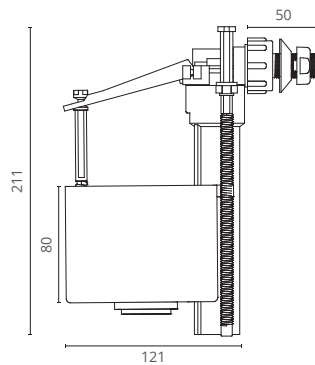

- Torneira boia de entrada de água lateral para autoclismos cerâmicos
- Enchimento rápido e silencioso
- Casquilho em latão

REF.	MEDIDAS			
BK0400050	3/8" -	10	20	
BK0400060	1/2" -	5	20	

# Simplex

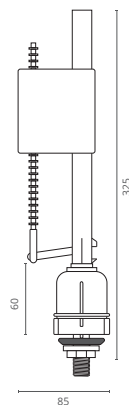

- Torneira boia de entrada de água inferior para autoclismos cerâmicos
- Enchimento rápido e silencioso
- Casquilho em latão
- Fácil ajuste em altura

REF.	MEDIDAS			
BK0400500	3/8" -	10	20	
BK0400540	1/2" -	5	20	

# Bi-flash

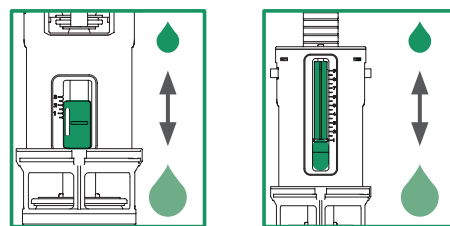

AJUSTE PARA CIMA PARA DESCARREGAR MENOS ÁGUA

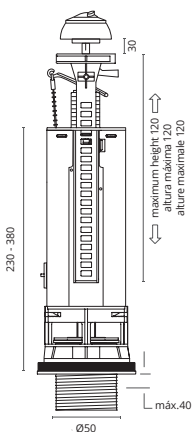

- Válvula de dupla descarga para autoclismos cerâmicos
- Botão cromado para aplicação universal
- Fácil regulação do volume de descarga máximo
- Fácil regulação do volume da meia descarga
- Fácil e rápida instalação e ajuste em altura
- Botão ajustável em altura
- Inclui parafusos de fixação em aço inox para cisterna

REF.

DESIGNAÇÃO



BK0410510

DUPLA DESCARGA -

5

20

# Duo

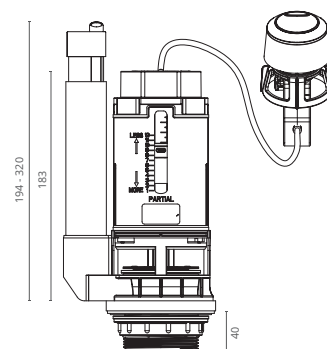

- Válvula de dupla descarga para autoclismos cerâmicos
- Botão cromado
- Fácil e rápida instalação e ajuste em altura
- Descarga regulável
- Posicionamento de botão ajustável para todo o tipo de cisternas
- Inclui parafusos de fixação em aço inox para cisterna

REF.

DESIGNAÇÃO



BK0410500

DUPLA DESCARGA -

5

20

# Press

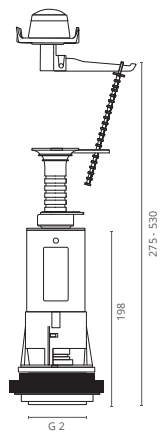

- Válvula de descarga simples para autoclismos cerâmicos
- Botão de premir cromado
- Fácil e rápida instalação e ajuste em altura
- Posicionamento de botão ajustável
- Inclui parafusos de fixação em aço inox para cisterna

REF.	DESIGNAÇÃO			
BK0410000	START / STOP - 	5	20	

# Pull

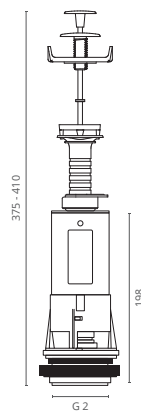

- Válvula de descarga simples para autoclismos cerâmicos
- Botão de puxar cromado
- Fácil e rápida instalação e ajuste em altura
- Posicionamento de botão ajustável
- Inclui parafusos de fixação em aço inox para cisterna

REF.	DESIGNAÇÃO			
BK0410100	PULL - 	5	20	

# Acessórios autoclismos



## TUBO DESCARGA

REF.	MEDIDAS			
BK1000000	Ø50 x Ø32 x 325 mm	1	20	
BK1000010	Ø50 x Ø32 x 600 mm	1	30	
BK1000020	Ø50 x Ø32 x 1000 mm	1	25	
BK1000030	Ø50 x Ø40 x 350 mm	1	20	

## TUBO DESCARGA AJUSTÁVEL

REF.	MEDIDAS			
BK1000150	Ø50 x Ø32 x 980 mm	1	20	

## TUBO DESCARGA P/ AUTOCLISMO ALTO

REF.	MEDIDAS			
BK1000100	Ø32	1	20	



## PORCA P/ TUBO DESCARGA

REF.	QUANTIDADE			
BK1050010	5 UN	1	20	

## ANILHA P/ TUBO DESCARGA

REF.	QUANTIDADE			
BK1050020	10 UN	1	20	



## VEDANTE CÓNICO P/ TUBO DESCARGA

REF.	QUANTIDADE			
BK1050000	10 UN	1	20	

## VEDANTE VÁLVULA DESCARGA

REF.	QUANTIDADE			
BK1002000	10 UN	1	20	

PARA AUTOCLISMOS CTESI®

# Acessórios



## VEDANTE VÁLVULA / CISTERNA

REF.	MEDIDAS / QUANTIDADE			
BK1002100	85 x 57 x 8 - 5 UN	-	50	

COMPATÍVEL COM TODAS AS LOUÇAS SANITÁRIAS



## JUNTA DE VEDAÇÃO - CISTERNA / SANITA

REF.	MEDIDAS / QUANTIDADE			
BK1002110	110 x 70 x 20 - 5 UN	-	30	

COMPATÍVEL COM TODAS AS VÁLVULAS DE DESCARGA



## PORCA PLÁSTICA P/ CASQUILHO

REF.	MEDIDAS / QUANTIDADE			
BK1050100	LATERAL 3/8" - 10 UN	-	10	
BK1050110	LATERAL 1/2" - 10 UN	-	10	



## PORCA PLÁSTICA P/ CASQUILHO

REF.	MEDIDAS - QUANTIDADE			
BK1050120	INFERIOR 3/8" - 10 UN	-	10	
BK1050130	INFERIOR 1/2" - 10 UN	-	10	



## TAMPÃO PLÁSTICO LATERAL

REF.	MEDIDAS - QUANTIDADE			
BK1050200	3/8" - 10 UN	-	10	
BK1050210	1/2" - 10 UN	-	10	



## TAMPÃO PLÁSTICO INFERIOR

REF.	MEDIDAS - QUANTIDADE			
BK1050220	3/8" - 5 UN	-	10	
BK1050230	1/2" - 5 UN	-	10	



## VEDANTE INFERIOR TORNEIRA BOIA

REF.	MEDIDAS / QUANTIDADE			
BK1002200	3/8" - 10 UN	-	10	
BK1002210	1/2" - 10 UN	-	10	



## BORRACHAS P/ KIT PARAFUSOS CISTERNA

REF.	QUANTIDADE			
BK1050320	10 UN	-	10	

COMPATÍVEL COM TODAS AS LOUÇAS SANITÁRIAS



## KIT 2 PARAFUSOS FIXAÇÃO CISTERNA

REF.	MEDIDAS			
BK1050310	M6 x 80 - INOX	5	10	

COMPATÍVEL COM TODAS AS LOUÇAS SANITÁRIAS



## EMBOQUE SANITA INTERIOR

REF.	MEDIDAS / QUANTIDADE			
BK2006000	Ø32/40 - 10 UN	-	25	



## EMBOQUE SANITA INTERIOR

REF.	MEDIDAS / QUANTIDADE			
BK2006020	1" - 10 UN	-	10	
BK2006021	1,1/4" - 10 UN	-	10	



# Tubos extensíveis

Na Ctesi® encontra uma ampla gama de tubos extensíveis desenhados e testados para se adaptarem às exigentes condições de instalação e uso. Toda a gama foi concebida para uma rápida e simples instalação nas mais diferentes necessidades e configurações dos locais onde são aplicados. Devido à sua forma cônica, o tubo adapta-se perfeitamente a qualquer ligação, o que garante uma ótima vedação.



O **gancho duplo** foi desenvolvido para que possa facilmente criar sifão através da sua aplicação num tubo extensível Ctesi®.

A gama Ctesi® completa-se ainda com um leque alargado de opções de tubos extensíveis com acabamento cromado resultando assim numa oferta que alia a simplicidade de instalação, a funcionalidade e desempenho e uma oferta que se preocupa com a estética das suas instalações sanitárias.

## Tubos extensíveis com gancho

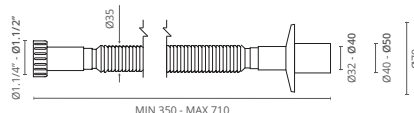
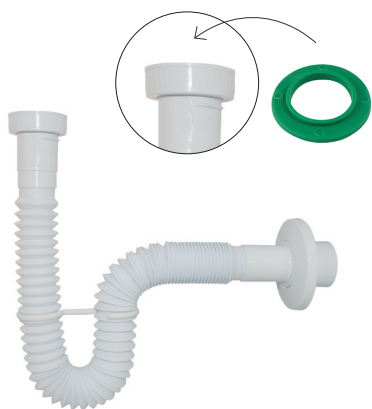

### C/ PORCA

REF.	MEDIDAS			
BK2001000	1,1/4" x 32/40	10	80	
BK2001020	1,1/2" x 40/50	10	80	

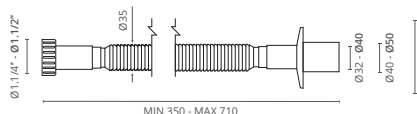

### CÓNICO

REF.	MEDIDAS			
BK2001100	1,1/4" x 32/40	10	80	
BK2001120	1,1/2" x 40/50	10	80	

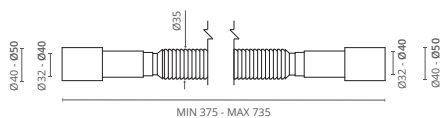

S/ PORCA

REF.	MEDIDAS			
BK2000000	32/40 x 32/40	10	100	
BK2000020	40/50 x 40/50	10	100	

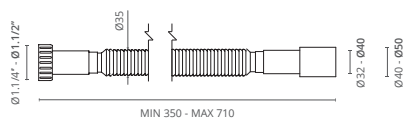
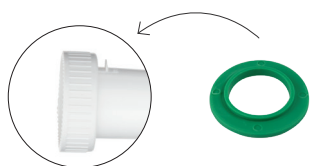

C/ PORCA

REF.	MEDIDAS			
BK2000100	1,1/4" x 32/40	10	100	
BK2000120	1,1/2" x 32/40	10	100	
BK2000121	1,1/2" x 40/50	10	100	

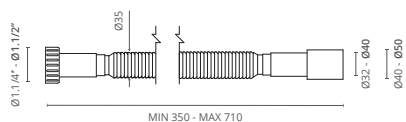
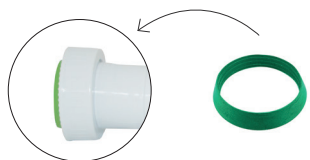

CÓNICO

REF.	MEDIDAS			
BK2000400	1,1/4" x 32/40	10	100	
BK2000421	1,1/2" x 40/50	10	100	

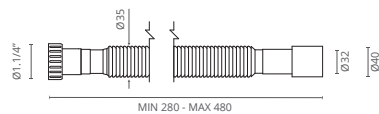
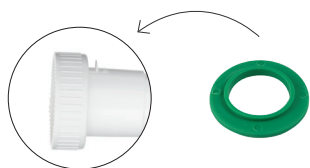

BIDÉ C/ PORCA

REF.	MEDIDAS			
BK2000200	1,1/4" x 32/40	10	100	



# Tubos extensíveis com válvula

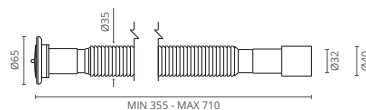

C/ VÁLVULA (ESPELHO Ø65)

REF.	MEDIDAS			
BK2000500	32/40	10	80	

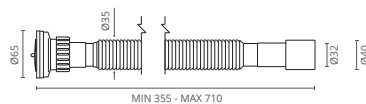

C/ VÁLVULA ROSCADA 1.1/4" (ESPELHO Ø65)

REF.	MEDIDAS			
BK2000550	1.1/4" x 32/40	10	80	

# Tubos extensíveis cromados

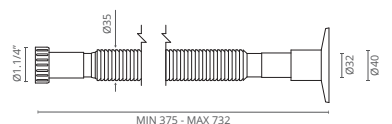
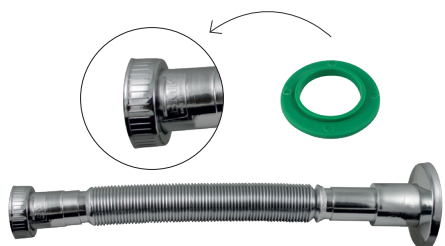

CROMADO C/ ESPELHO

REF.	MEDIDAS			
BK2000600	1.1/4" x 32/40	10	100	

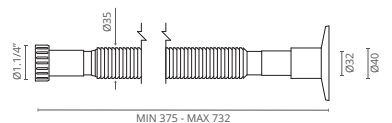
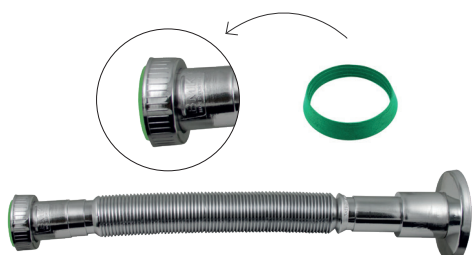

CÔNICO CROMADO C/ ESPELHO

REF.	MEDIDAS			
BK2000700	1.1/4" x 32/40	10	100	

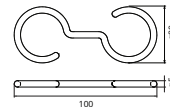
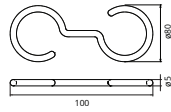

## GANCHO CROMADO P/ TUBO EXTENSÍVEL

REF.	COR / QUANTIDADE			
BK2050110	CROMADO - 10 UN	-	20	

## GANCHO BRANCO P/ TUBO EXTENSÍVEL

REF.	COR / QUANTIDADE			
BK2050100	BRANCO - 10 UN	-	20	

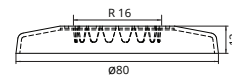
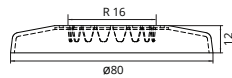
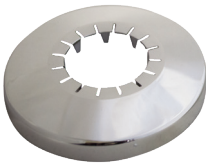

## ESPELHO CROMADO P/ TUBO EXTENSÍVEL

REF.	MEDIDAS / QUANTIDADE			
BK2050210	Ø32 / 40 - 10 UN	-	20	

## ESPELHO BRANCO P/ TUBO EXTENSÍVEL

REF.	MEDIDAS / QUANTIDADE			
BK2050200	Ø32 / 40 - 10 UN	-	20	

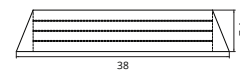
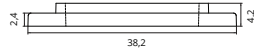

## ANILHAS P/ TUBO EXTENSÍVEL

REF.	MEDIDAS / QUANTIDADE			
BK2050000	1.1/4" - 10 UN	-	50	
BK2050010	1.1/2" - 10 UN	-	50	

## VEDANTE CÔNICO P/ TUBO EXTENSÍVEL

REF.	MEDIDAS / QUANTIDADE			
BK2050020	1.1/4" - 10 UN	-	50	
BK2050030	1.1/2" - 10 UN	-	50	

# Excêntricos e canhões de sanita

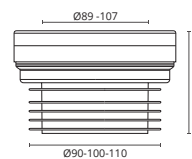

FLEXY CANHÃO SANITA DIREITO

REF.	MEDIDAS			
BK2002200	Ø 90 / 100 / 110 mm	10	40	

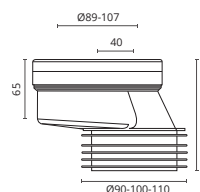

FLEXY EXCÊNTRICO SANITA 40 mm

REF.	MEDIDAS			
BK2002220	Ø 90 / 100 / 110 mm - 40 mm	10	20	

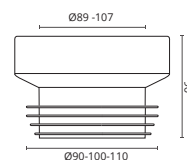

FITA CANHÃO SANITA DIREITO

REF.	MEDIDAS			
BK2002000	Ø 90 / 100 / 110 mm	10	75	

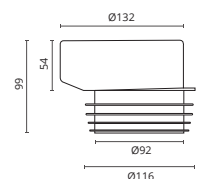

FITA EXCÊNTRICO SANITA 40 mm

REF.	MEDIDAS			
BK2002100	Ø 90 / 100 / 110 mm - 40 mm	10	75	



# Curvas e tubos da sanita

Especialmente indicada para fácil ligação ao chão em sanitas de descarga à parede.  
Ajustável através de corte até 110 mm  
Saída: Ø90/100/110 mm

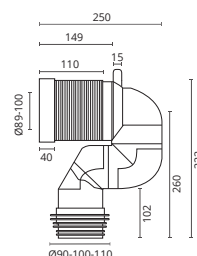
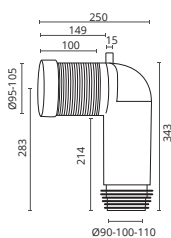
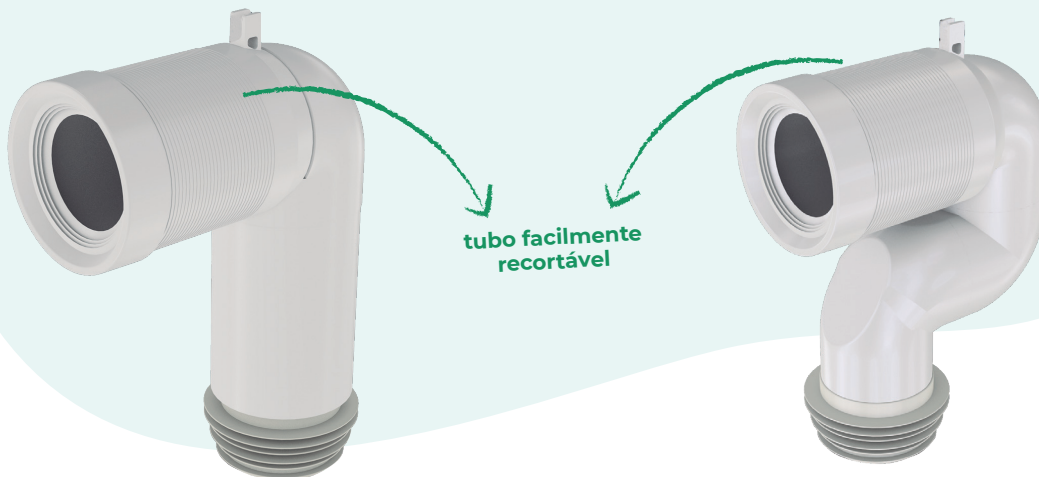

## CURVA SANITA "90°"

REF.	MEDIDAS			
BK2002820	Ø90/100/110 mm	2	20	

## CURVA SANITA "S"

REF.	MEDIDAS			
BK2002800	Ø90/100/110 mm	2	20	

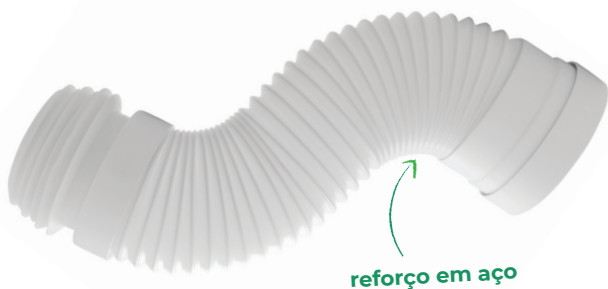

### Resistente

- Parte extensível com inserção de aço
- Flexível de longa duração
- Não aderente a impurezas

### Universal

- Borrachas de vedação flexíveis em PVC
- Extensível de 30 a 55 cm
- Compatível com todas as sanitas



Ideal para renovação dada a facilidade de aplicação sem necessidade de retirar a sanita. Adapta-se a todas as configurações, mesmo as mais complexas.

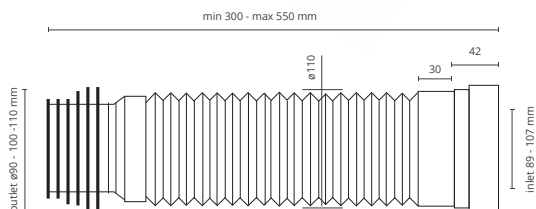

## TUBO EXTENSÍVEL P/ SANITA

REF.	MEDIDAS			
BK2002500	90/110 x 300/550 mm	5	30	

# ISOL

## Tela impermeabilizante

### Características técnicas

	Método de ensaio	Resultado
Largura (cm)	EN 1848-2	150 ± 2 cm
Peso (g/m <sup>2</sup> )	EN 1849-2	240 ± 10 gr/m <sup>2</sup>
Comprimento	EN 1848-2	30 metros / rolo
Um rolo	-	45 m <sup>2</sup>
Peso de um rolo	-	9,5 kg / rolo ± 0,5
Resistência à difusão de vapor de água	EN 1931	Sd: < 6
Estanquidade	EN 1928	W1 Class
Resistência à ruptura transversal (Nail Shank)	EN 12310-1	295 N ± 30
Resistência à ruptura longitudinal (Nail Shank)	EN 12310-1	215 N ± 25
Resistência à tracção transversal	EN 12311-1	575 N/5 cm ± 30 N/5 cm
Resistência à tracção longitudinal	EN 12311-1	695 N/5 cm ± 40 N/5 cm
Alongamento longitudinal	EN 12311-1	45% ± 6%
Alongamento na ruptura	EN 12311-1	48 ± 8%
Resistência à temperatura	-	-10°C / +60°C
Reacção ao fogo	EN 11925-2	Class E
Composição	-	PP/PU/PP
Garantia	Garantia do produto: 10 anos.	
Certificado de acordo com a norma	EN 13859-1	-
Armazenamento	O produto deve ser armazenado num local fresco e seco, sem exposição à luz solar.	

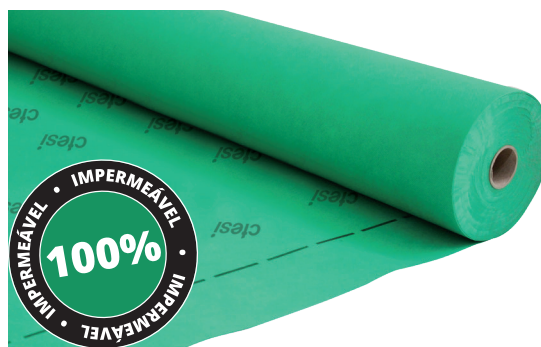

- ISOL é uma Tela Impermeabilizante de 3 camadas composta por PP/PU/PP (polipropileno/poliuretano/polipropileno)
- Recomenda-se a sua aplicação para impermeabilização sob cerâmica de pavimento e revestimento, e/ou bases de duche em casas de banho
- É 100% à prova d'água, flexível e fácil de aplicar
- Excelente aderência ao cimento
- Leve e simultaneamente bastante resistente
- Resistente e resiliente (conforme as normas EN12310 e EN12311)
- Resistente ao fogo (conforme norma EN11925)

### TELA IMPERMEABILIZANTE

REF.	MEDIDAS			
BK4029000	1,5 x 5 m	1	-	-
BK4029010	1,5 x 10 m	1	-	-
BK4029020	1,5 x 20 m	1	-	-
BK4029030	1,5 x 30 m	1	-	-

- Adesivo: borracha sintética
- TemperatWura de aplicação: 5°C
- Armazenamento: 15°C - 25°C por 18 meses sem expor a luz solar
- Aplicar a cola de azulejo Classe C2 por cima da fita
- Aplicar directamente na aba da calha de duche
- Para impermeabilização de calhas de duche

### FITA ADESIVA PARA CALHAS DE DUCHE

REF.	MEDIDAS			
BK4029550	3000 x 7,5 cm	1	-	-

- Fita para aplicação em juntas, pré-cortada, feita a partir da tela impermeabilizante
- Aplica-se para impermeabilização de juntas de parede e chão, limites horizontais ou verticais

### ROLO DE FITA PARA JUNTAS

REF.	MEDIDAS			
BK4029500	2500 x 12,5 cm	1	-	-

- Fita para aplicação em juntas, pré-cortada e impermeável
- Utiliza-se para a impermeabilização de cantos interiores em todas as áreas húmidas

### CANTO IMPERMEÁVEL INTERIOR

REF.	MEDIDAS			
BK4029200	12,5 x 12,5 x 6,25 cm	1	12	-

- Fita para aplicação em juntas, pré-cortada e impermeável
- Utiliza-se para a impermeabilização de cantos exteriores em todas as áreas húmidas

### CANTO IMPERMEÁVEL EXTERIOR

REF.	MEDIDAS			
BK4029220	12,5 x 12,5 x 6,25 cm	1	12	-

Pode ser aplicado por colagem com cola de azulejo da classe C2, à base de epóxi ou massa de poliuretano (PU). Não pode ser aplicado com adesivos que contenham solventes. Recomenda-se a aplicação de massa de poliuretano na linha final das juntas.

# 6 Passos para aplicação

da tela impermeabilizante ISOL

## Preparação antes da aplicação

A superfície deve estar limpa, seca e sem substâncias granulares que impeçam a aderência

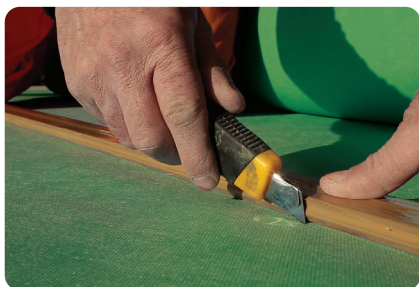

## Corte a tela nas medidas pretendidas

ISOL pode ser cortada em qualquer medida pretendida, de acordo com a área onde vai ser aplicada.



## Aplicação da cola

A ISOL adere a superfícies horizontais e verticais com cola própria para azulejos de classe C2 TE S1. Este tipo de cola é aplicado diretamente na superfície com uma espátula dentada.



## Colagem da tela

ISOL deve ser colocada de acordo com a direção do fluxo de água antes que a cola seque. Deve haver uma sobreposição de 10 cm nas juntas.

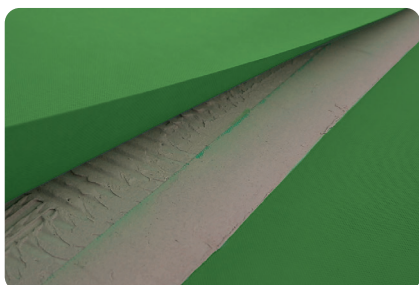

## Sobreposição de juntas

10 cm. As sobreposições são coladas com cola de azulejos C2 TE S1. Para garantir uma melhor aderência, as bolhas de ar são removidas aplicando pressão com um lado plano da espátula.

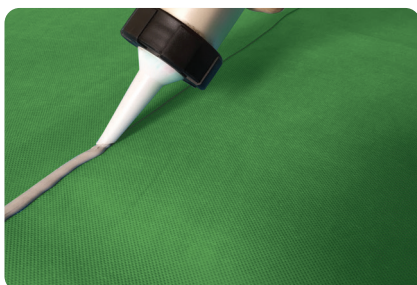

## Selagem de juntas com cola poliuretano

As extremidades das juntas da tela devem ser seladas com mastique PU.



## Cobertura da tela

ISOL pode ser coberta com materiais de revestimento, como por exemplo a cerâmica.



Preparação da superfície



instalação da calha de duche

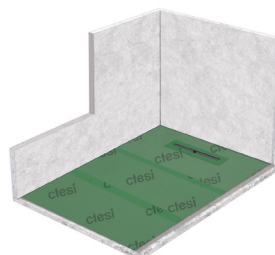

Aplicação da tela impermeabilizante ISOL no chão

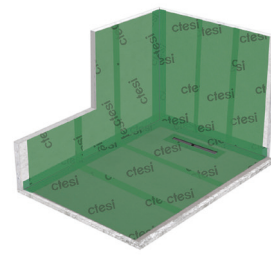

Aplicação da tela impermeabilizante ISOL nas paredes

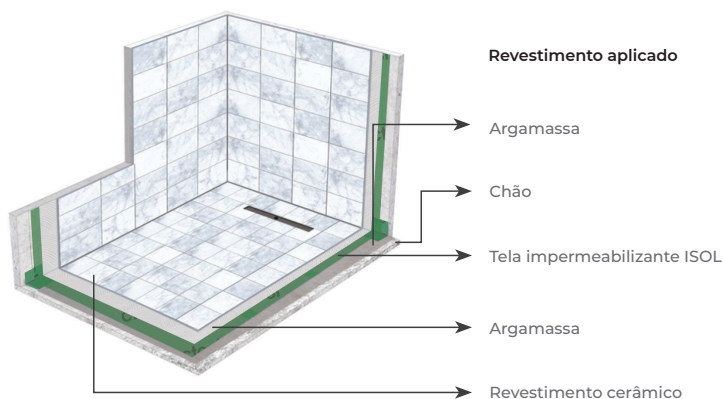

A Tela impermeabilizante ISOL é indicada para o isolamento e vedação de bases de duche.

# Kits calhas de duche

Os **kits de calha de duche da Ctesi®** são a opção para a construção de um espaço de banho com sistemas de drenagem eficiente.

Este kit é composto por uma calha de duche em polipropileno, grelha de aço inox, tela impermeabilizante ISOL com um 1,5 x 2 m para garantir o isolamento completo do espaço de banho e ainda uma cola apropriada para aplicação da tela.

Defina o seu espaço de banho e garanta o melhor sistema de drenagem com uma impermeabilização efetiva.

Todos os componentes do kit de calhas de duche têm a garantia da qualidade da **Ctesi®**.

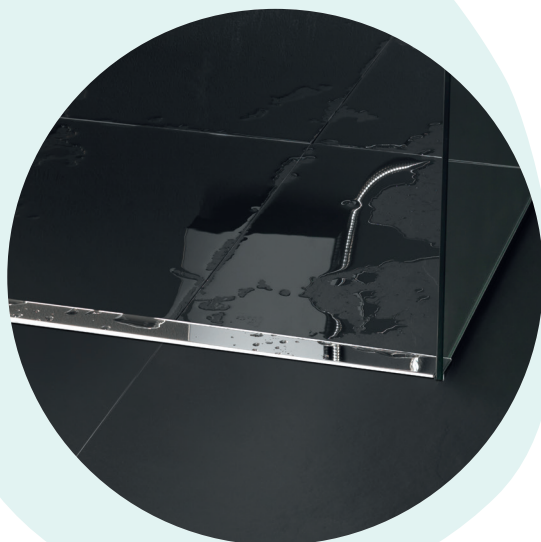

## Kit Way Line

Personalize a grelha da calha com a mesma cerâmica utilizada no pavimento, para isso basta inverter a face da grelha e aplicar a cerâmica, que deve ter uma espessura de 6 mm.

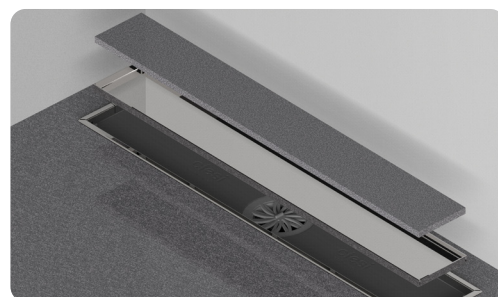

- Calha de duche com corpo em polipropileno
- Grelha e Aro em aço inox AISI 304
- Inclui niveladores para melhor adaptabilidade
- Disponível nos comprimentos de 330, 400, 500, 600, 700 e 800 mm
- Largura de 60 mm
- Equipado com sistema anti-odores
- Para aplicação em espaços de duche
- Alta resistência química e a temperaturas entre -30C° +75C°

·Tela Impermeabilizante ISOL com 1,5 x 2m

### WAY KIT LINE

REF.	MEDIDAS			
BK4023200	330 x 60mm	1	-	-
BK4023210	400 x 60mm	1	-	-
BK4023220	500 x 60mm	1	-	-
BK4023230	600 x 60mm	1	-	-
BK4023240	700 x 60mm	1	-	-
BK4023250	800 x 60mm	1	-	-

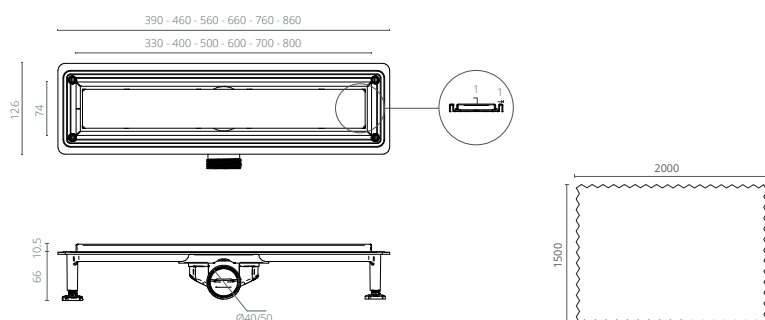



# Kit Way Square

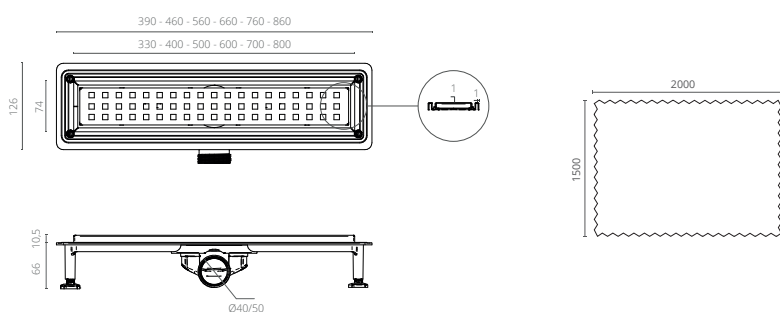
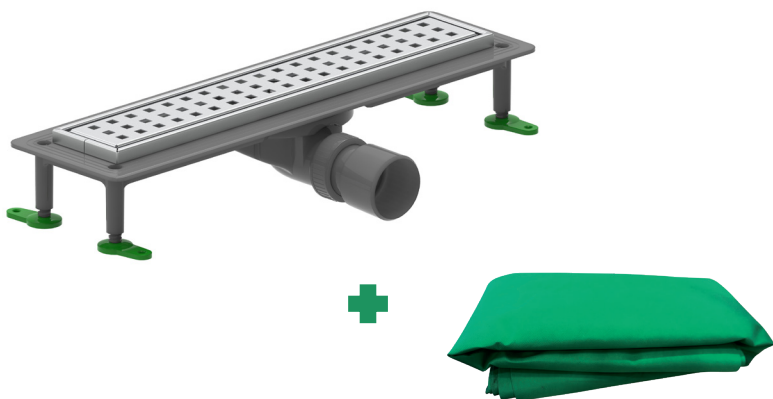

- Calha de duche com corpo em polipropileno
- Grelha e Aro em aço inox AISI 304
- Inclui niveladores para melhor adaptabilidade
- Disponível nos comprimentos de 330, 400, 500, 600, 700 e 800 mm
- Largura de 60 mm
- Equipado com sistema anti-odores
- Para aplicação em espaços de duche
- Alta resistência química e a temperaturas entre -30C° +75C°

· Tela Impermeabilizante ISOL com 1,5 x 2m

## KIT WAY SQUARE

REF.	MEDIDAS			
BK4023400	330 x 60mm	1	-	-
BK4023410	400 x 60mm	1	-	-
BK4023420	500 x 60mm	1	-	-
BK4023430	600 x 60mm	1	-	-
BK4023440	700 x 60mm	1	-	-
BK4023450	800 x 60mm	1	-	-

# Kit Way Round

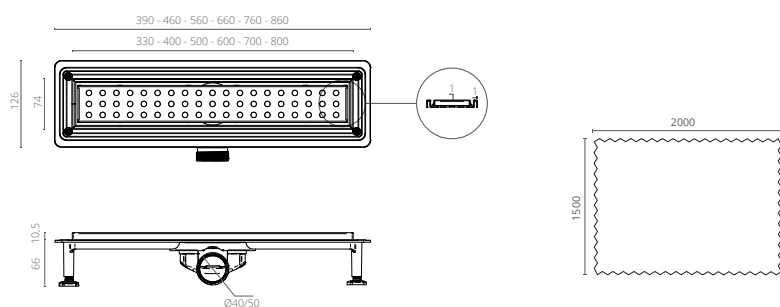

- Calha de duche com corpo em polipropileno
- Grelha e Aro em aço inox AISI 304
- Inclui niveladores para melhor adaptabilidade
- Disponível nos comprimentos de 330, 400, 500, 600, 700 e 800 mm
- Largura de 60 mm
- Equipado com sistema anti-odores
- Para aplicação em espaços de duche
- Alta resistência química e a temperaturas entre -30C° +75C°

· Tela Impermeabilizante ISOL com 1,5 x 2m

## KIT WAY ROUND

REF.	MEDIDAS			
BK4023600	330 x 60mm	1	-	-
BK4023610	400 x 60mm	1	-	-
BK4023620	500 x 60mm	1	-	-
BK4023630	600 x 60mm	1	-	-
BK4023640	700 x 60mm	1	-	-
BK4023650	800 x 60mm	1	-	-



# Calhas de duche

## Estética e eficácia

Com as calhas de duche Ctesi® damos-lhe a possibilidade de construir um espaço amplo e com livre acesso ao duche, numa perfeita simbiose entre a estética minimalista e uma drenagem eficiente.

As calhas de duche Ctesi® garantem uma drenagem rápida e eficaz enquanto conferem ao seu espaço de banho uma beleza ímpar, ocultando o sifão e possibilitando que o espaço de duche seja pavimentado com o material da sua eleição.

- Calhas de duche fornecido com Tela Impermeabilizante ISOL, para melhor isolamento
- Inclui niveladores para melhor adaptabilidade
- Para aplicação em espaços de duche
- Disponível nos comprimentos de 330, 400, 500, 600, 700 e 800mm
- Equipadas com sistema anti-retorno de odores
- Alta resistência química e a temperaturas entre os -30°C e os +75°C

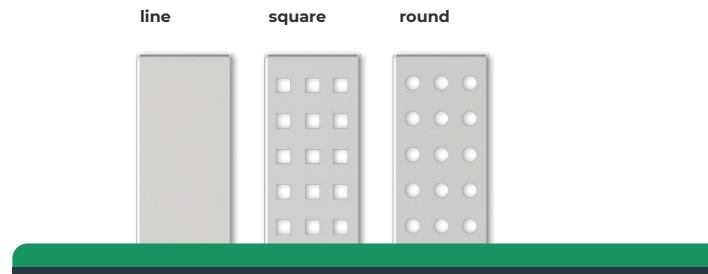
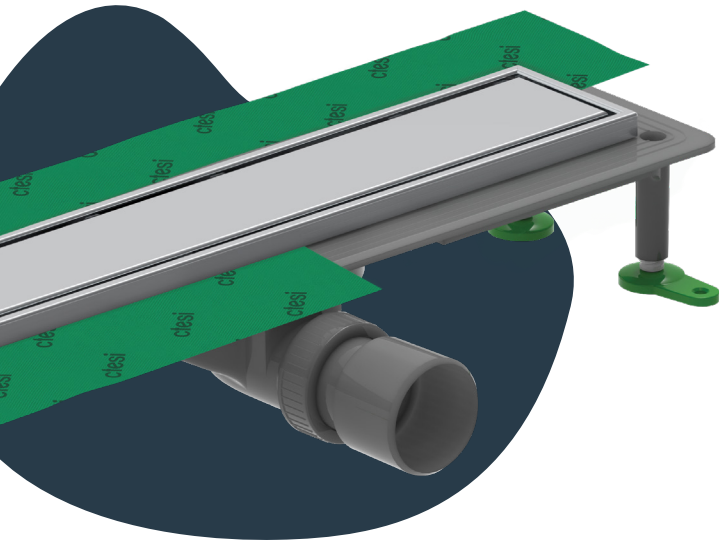

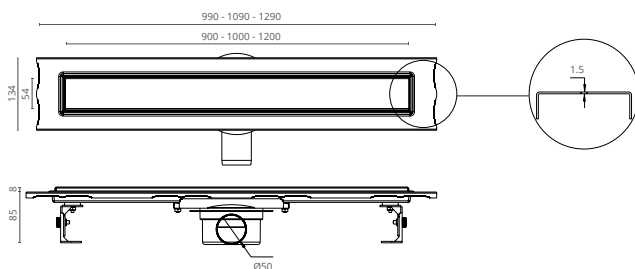
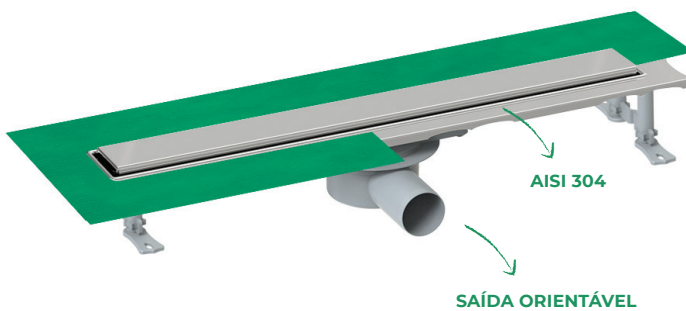

## Line



- Calha de duche com corpo, aro e grelha em aço inox AISI 304
- Fornecido com Tela Impermeabilizante ISOL
- Inclui niveladores para melhor adaptabilidade
- Para aplicação em espaços de duche
- Disponível nos comprimentos de 900, 1000 e 1200 mm, com a largura de 60 mm
- Equipado com sistema anti-odores
- Alta resistência química e a temperaturas entre -30°C +75°C

### LINE

REF.	MEDIDAS			
BK4022520	900 x 60mm	1	10	
BK4022530	1000 x 60mm	1	10	
BK4022540	1200 x 60mm	1	10	

# Way Line

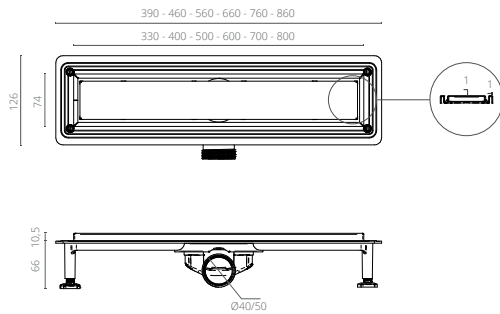
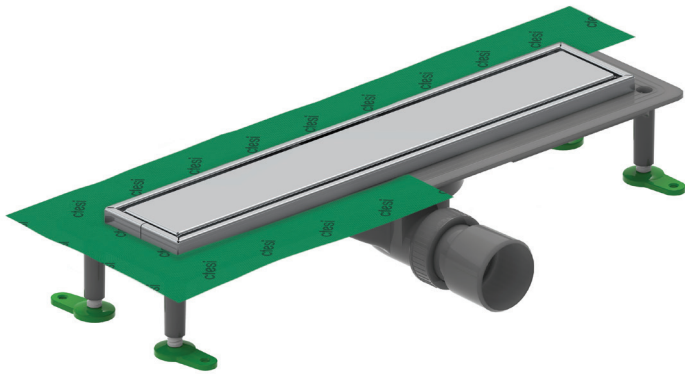

Personalize a grelha da calha com a mesma cerâmica utilizada no pavimento, para isso basta inverter a face da grelha e aplicar a cerâmica, que deve ter uma espessura de 6 mm.

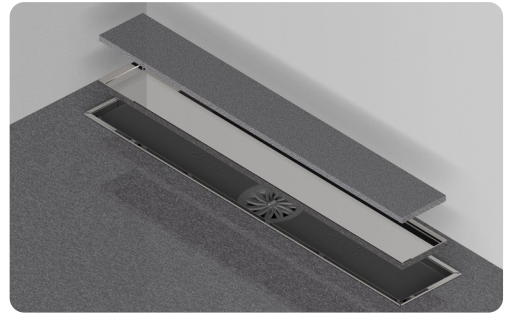

- Calha de duche com corpo em polipropileno
- Grelha e Aro em aço inox AISI 304
- Fornecido com Tela Impermeabilizante ISOL
- Inclui niveladores para melhor adaptabilidade
- Para aplicação em espaços de duche
- Disponível nos comprimentos de 330, 400, 500, 600, 700 e 800 mm
- Largura de 60 mm
- Equipado com sistema anti-odores
- Alta resistência química e a temperaturas entre -30°C +75°C

## WAY LINE

REF.	MEDIDAS			
BK4024000	330 x 60mm	1	10	
BK4024010	400 x 60mm	1	10	
BK4024020	500 x 60mm	1	10	
BK4024030	600 x 60mm	1	10	
BK4024040	700 x 60mm	1	10	
BK4024050	800 x 60mm	1	10	

# Way Square

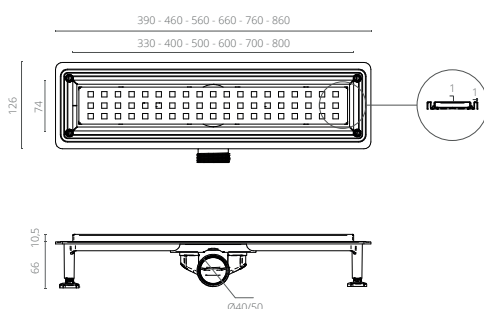
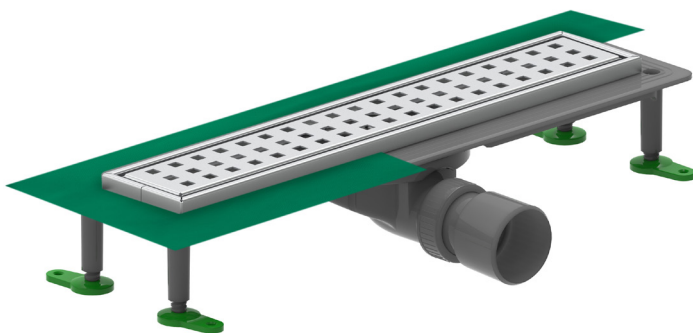

- Calha de duche com corpo em polipropileno
- Grelha e Aro em aço inox AISI 304
- Fornecido com Tela Impermeabilizante ISOL
- Inclui niveladores para melhor adaptabilidade
- Para aplicação em espaços de duche
- Disponível nos comprimentos de 330, 400, 500, 600, 700 e 800 mm
- Largura de 60 mm
- Equipado com sistema anti-odores
- Alta resistência química e a temperaturas entre -30°C +75°C

## WAY SQUARE

REF.	MEDIDAS			
BK4024100	330 x 60mm	1	10	
BK4024110	400 x 60mm	1	10	
BK4024120	500 x 60mm	1	10	
BK4024130	600 x 60mm	1	10	
BK4024140	700 x 60mm	1	10	
BK4024150	800 x 60mm	1	10	

# Way Round

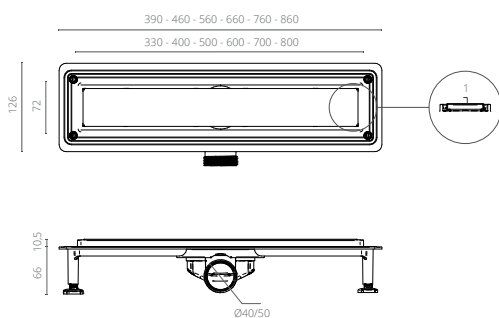
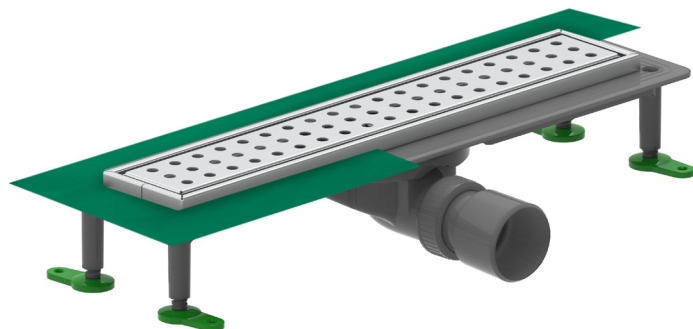

- Calha de duche com corpo em polipropileno
- Grelha e Aro em aço inox AISI 304
- Fornecido com Tela Impermeabilizante ISOL
- Inclui niveladores para melhor adaptabilidade
- Para aplicação em espaços de duche
- Disponível nos comprimentos de 330, 400, 500, 600, 700 e 800 mm
- Largura de 60 mm
- Equipado com sistema anti-odores
- Alta resistência química e a temperaturas entre -30°C +75°C

## WAY ROUND

REF.	MEDIDAS			
BK4024200	330 x 60mm	1	10	
BK4024210	400 x 60mm	1	10	
BK4024220	500 x 60mm	1	10	
BK4024230	600 x 60mm	1	10	
BK4024240	700 x 60mm	1	10	
BK4024250	800 x 60mm	1	10	

# Flow Line

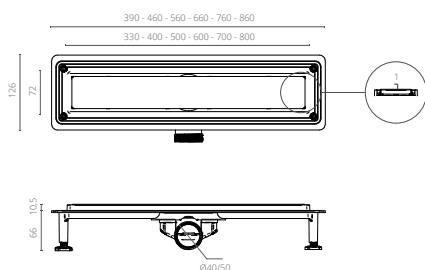
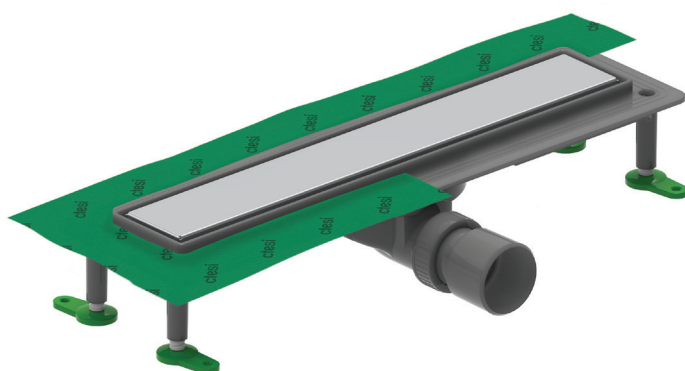

- Calha de duche com corpo em polipropileno
- Grelha em aço inox AISI 304
- Fornecido com Tela Impermeabilizante ISOL
- Inclui niveladores para melhor adaptabilidade
- Para aplicação em espaços de duche
- Disponível nos comprimentos de 330, 400, 500, 600, 700 e 800 mm
- Largura de 60 mm
- Equipado com sistema anti-odores
- Alta resistência química e a temperaturas entre -30°C +75°C

## FLOW LINE

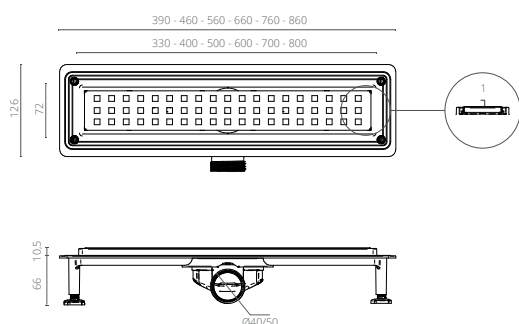
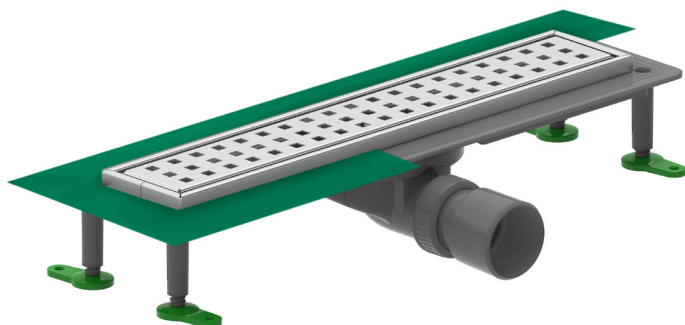

REF.	MEDIDAS			
BK4024500	330 x 60 mm	1	10	
BK4024510	400 x 60 mm	1	10	
BK4024520	500 x 60 mm	1	10	
BK4024530	600 x 60 mm	1	10	
BK4024540	700 x 60 mm	1	10	
BK4024550	800 x 60 mm	1	10	

# Flow Square



- Calha de duche com corpo em polipropileno
- Grelha em aço inox AISI 304
- Fornecido com Tela Impermeabilizante ISOL
- Inclui niveladores para melhor adaptabilidade
- Para aplicação em espaços de duche
- Disponível nos comprimentos de 330, 400, 500, 600, 700 e 800 mm
- Largura de 60 mm
- Equipado com sistema anti-odores
- Alta resistência química e a temperaturas entre -30°C +75°C

## FLOW SQUARE

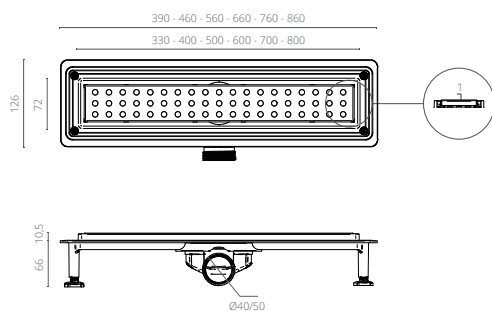

REF.	MEDIDAS			
BK4024600	330 x 60mm	1	10	
BK4024610	400 x 60mm	1	10	
BK4024620	500 x 60mm	1	10	
BK4024630	600 x 60mm	1	10	
BK4024640	700 x 60mm	1	10	
BK4024650	800 x 60mm	1	10	

# Flow Round



- Calha de duche com corpo em polipropileno
- Grelha em aço inox AISI 304
- Fornecido com Tela Impermeabilizante ISOL
- Inclui niveladores para melhor adaptabilidade
- Para aplicação em espaços de duche
- Disponível nos comprimentos de 330, 400, 500, 600, 700 e 800 mm
- Largura de 60 mm
- Equipado com sistema anti-odores
- Alta resistência química e a temperaturas entre -30°C +75°C

## FLOW ROUND

REF.	MEDIDAS			
BK4024700	330 x 60mm	1	10	
BK4024710	400 x 60mm	1	10	
BK4024720	500 x 60mm	1	10	
BK4024730	600 x 60mm	1	10	
BK4024740	700 x 60mm	1	10	
BK4024750	800 x 60mm	1	10	

# Sifões de pavimento

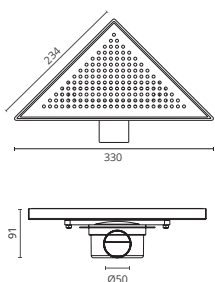
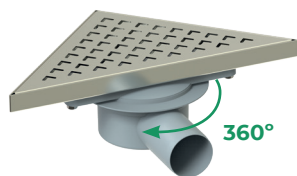

- Sifão de pavimento com corpo em PVC com rotação 360°
- Grelha em aço inox AISI 304
- Com anti-retorno de odores
- Para aplicação em espaços de duche

## SQUARE SIFÃO DE PAVIMENTO

REF.	MEDIDAS			
BK4020511	230 x 230 - Ø50mm	1	8	

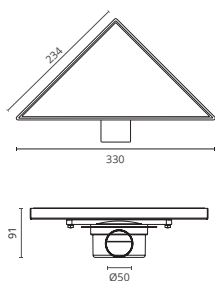
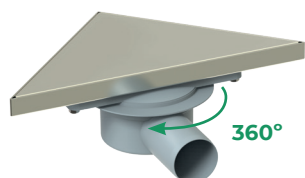

- Sifão de pavimento com corpo em PVC com rotação 360°
- Grelha em aço inox AISI 304
- Com anti-retorno de odores
- Para aplicação em espaços de duche

## LINE SIFÃO DE PAVIMENTO

REF.	MEDIDAS			
BK4020611	230 x 230 - Ø50mm	1	8	

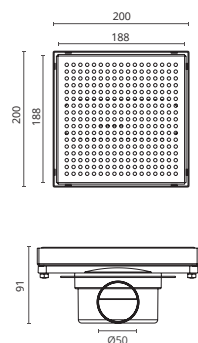
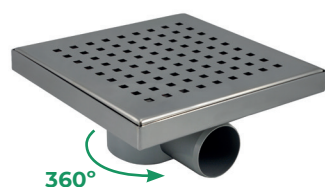

- Sifão de pavimento com corpo em PVC com rotação 360°
- Grelha em aço inox AISI 304
- Com anti-retorno de odores
- Para aplicação em espaços de duche

## SQUARE SIFÃO DE PAVIMENTO

REF.	MEDIDAS			
BK4020501	200 x 200 - Ø50mm	1	8	

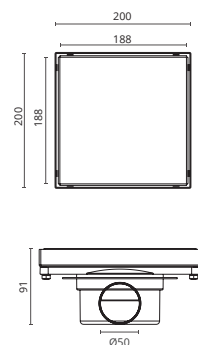
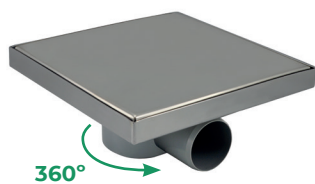

- Sifão de pavimento com corpo em PVC com rotação 360°
- Grelha em aço inox AISI 304
- Com anti-retorno de odores
- Para aplicação em espaços de duche

## LINE SIFÃO DE PAVIMENTO

REF.	MEDIDAS			
BK4020601	200 x 200 - Ø50mm	1	8	

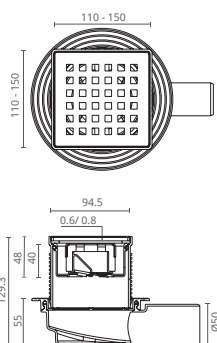
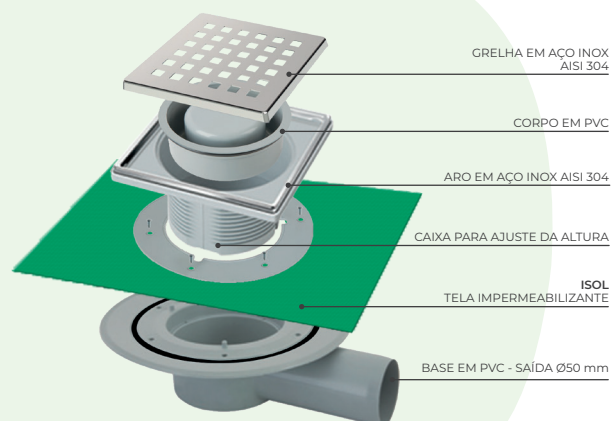
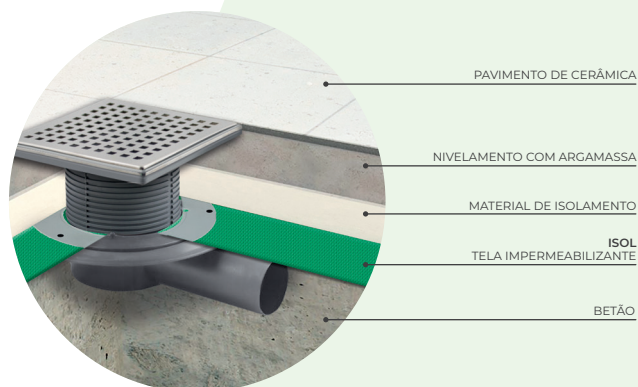

## ALTURA AJUSTÁVEL / SAÍDA ORIENTÁVEL



- Sifão de pavimento com corpo em PVC
- Grelha em aço inox AISI 304
- Altura ajustável / saída orientável
- Indicado para isolamento e impermeabilização da água
- Com anti-retorno de odores
- Para aplicação em espaços de duche
- Tela Impermeabilizante ISOL com 1,5 x 2m

## KIT SQUARE

## SIFÃO AJUSTÁVEL COM TELA IMPERMEABILIZANTE

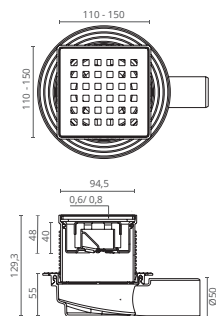
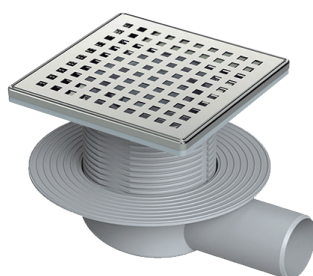

REF.	MEDIDAS			
BK4021000	100 x 100 x Ø50mm	1	6	
BK4021010	150 x 150 x Ø50mm	1	6	



- Sifão de pavimento com corpo em PVC
- Grelha em aço inox AISI 304
- Altura ajustável / saída orientável
- Indicado para isolamento e impermeabilização da água
- Com anti-retorno de odores
- Para aplicação em espaços de duche, varandas, terraços e/ou caves
- Aplicado à altura do pavimento

## SQUARE

## SIFÃO CHÃO HORIZONTAL

REF.	MEDIDAS			
BK4020200	110 x 110 x Ø50 mm	1	24	
BK4020210	150 x 150 x Ø50 mm	1	24	



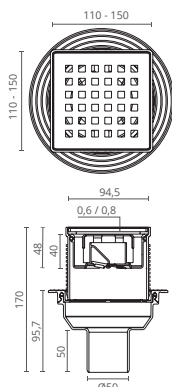

- Sifão de pavimento com corpo em PVC
- Grelha em aço inox AISI 304
- Altura ajustável
- Indicado para isolamento e impermeabilização da água
- Com anti-retorno de odores
- Para aplicação em espaços de duche, varandas, terraços e/ou caves
- Aplicado à altura do pavimento

#### SQUARE SIFÃO CHÃO VERTICAL

REF.	MEDIDAS			
BK4020205	110 x 110 x Ø50 mm	1	24	
BK4020215	150 x 150 x Ø50 mm	1	24	

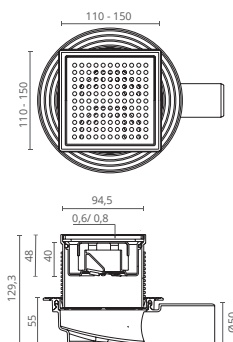
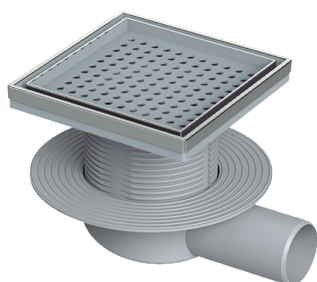

- Sifão de pavimento com corpo em PVC
- Aro em aço inox AISI 304
- Altura ajustável / saída orientável
- Com anti-retorno de odores
- Para aplicação em espaços de duche, varandas, terraços e/ou caves
- Para aplicação com cerâmica (máx. 7 mm)

#### SQUARE SIFÃO CHÃO HORIZONTAL P/ CERÂMICA

REF.	MEDIDAS			
BK4020250	110 x 110 x Ø50 mm	1	24	
BK4020260	150 x 150 x Ø50 mm	1	24	

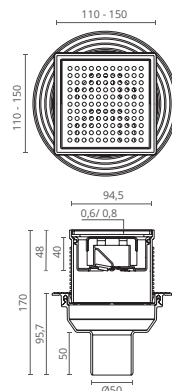
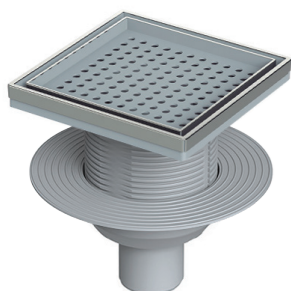

- Sifão de pavimento com corpo em PVC
- Aro em aço inox AISI 304
- Altura ajustável
- Com anti-retorno de odores
- Para aplicação em espaços de duche, varandas, terraços e/ou caves
- Para aplicação com cerâmica (máx. 7 mm)

#### SQUARE SIFÃO CHÃO VERTICAL P/ CERÂMICA

REF.	MEDIDAS			
BK4020255	110 x 110 x Ø50 mm	1	24	
BK4020265	150 x 150 x Ø50 mm	1	24	

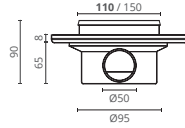

- Sifão de pavimento com corpo em PVC
- Grelha em aço inox AISI 304
- Saída orientável
- Com anti-retorno de odores
- Para aplicação em espaços de duche, varandas, terraços e/ou caves

#### SQUARE

##### SIFÃO CHÃO HORIZONTAL P/ REMATE

REF.	MEDIDAS			
BK4020300	110 x 110 x Ø50 mm	1	24	
BK4020310	150 x 150 x Ø50 mm	1	24	

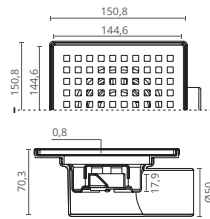

- Sifão de pavimento com corpo em PVC
- Grelha em aço inox AISI 304
- Saída orientável
- Com anti-retorno de odores
- Para aplicação em espaços de duche, varandas, terraços e/ou caves

#### SQUARE

##### SIFÃO CHÃO HORIZONTAL

REF.	MEDIDAS			
BK4020000	110 x 110 x Ø50 mm	1	32	
BK4020010	150 x 150 x Ø50 mm	1	20	

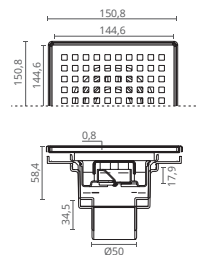

- Sifão de pavimento com corpo em PVC
- Grelha em aço inox AISI 304
- Com anti-retorno de odores
- Para aplicação em espaços de duche, varandas, terraços e/ou caves

#### SQUARE

##### SIFÃO CHÃO VERTICAL

REF.	MEDIDAS			
BK4020100	110 x 110 x Ø50 mm	1	45	
BK4020110	150 x 150 x Ø50 mm	1	28	

# PETRA & DRAIN



**Filtro "Anti-Cabelos"**  
de fácil acesso pelo utilizador final



## Válvulas de duche

### Para uma drenagem rápida e eficaz

As válvulas de duche Ctesi® foram desenhadas para permitir uma rápida e simples instalação e um fácil acesso para manutenção, garantindo uma drenagem perfeita em qualquer tipo de instalação.

O sistema de retenção de impurezas evita o arrastamento da sujidade para a rede de drenagem, enquanto contribui como anti-retorno dos odores.

As grelhas em ABS cromado e com design moderno são o acabamento perfeito para embelezar a sua base de duche.

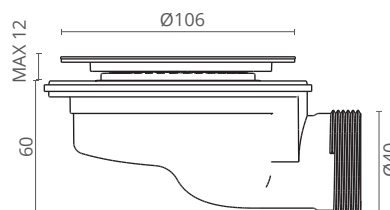

- Inclui aro em aço inox para fixação na base de duche
- Altura reduzida: ideal para bases de duche extraplanas
- Higiénica: equipada com sistema anti-retorno (de águas e odores)
- Prática: fácil retirada de filtro anti-cabelos por parte do utilizador final
- Drenagem Eficaz: caudal bastante superior aos critérios exigidos na EN-274 (> 24L/min)
- Inovadora: sistema de drenagem inovador (Pedido de Patente: Depositado)
- Saída: Ø40 mm (interior) ou 1.1/2" (exterior)
- Entrada: para furação Ø90 mm

#### PETRA VÁLVULA DE DUCHE

REF.	MEDIDAS			
BK4000360	Ø106 mm	1	48	768

INDICADO PARA BASES DE DUCHE MINERAIS EXTRAPLANAS | FURAÇÃO Ø90

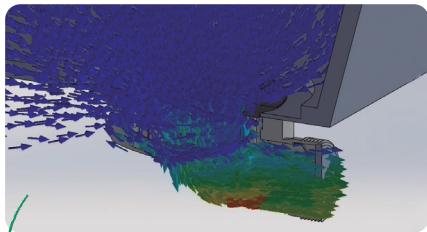
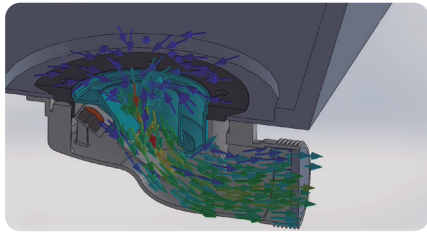
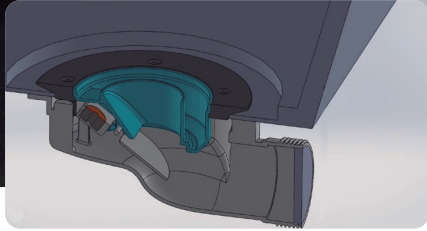

## SISTEMA INOVADOR CAUDAL DE DRENAGEM ELEVADO

Velocidade de fluxo bem acima dos critérios exigidos pela norma europeia EN-274 (> 24L / min)

**Filtro "Anti-Cabelos"**  
de fácil acesso pelo utilizador final

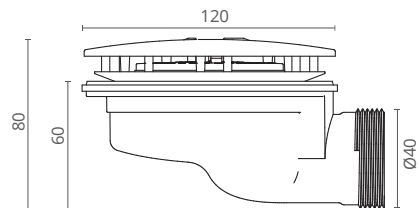

- Altura reduzida: ideal para bases de duche extraplanas
- Higiénica: equipada com sistema anti-retorno (de águas e odores)
- Prática: fácil retirada de filtro anti-cabelos por parte do utilizador final
- Drenagem Eficaz: caudal bastante superior aos critérios exigidos na EN-274 (> 24L/min)
- Inovadora: sistema de drenagem inovador (Pedido de Patente: Depositado)
- Tampa Ø120mm
- Saída: Ø40 mm (interior) ou 1,1/2" (exterior)
- Entrada: para furação Ø90 mm

### DRAIN VÁLVULA DE DUCHE

REF.	MEDIDAS	COR			
BK4000350	Ø120mm	CROMADO	1	48	768

INDICADO PARA BASES DE DUCHE EXTRAPLANAS | FURAÇÃO Ø90

# Ducheta cromada

## Mais conforto, mais higiene

As duchetas higiênicas Ctesi® proporcionam-lhe mais conforto na sua higiene pessoal e são indicadas para substituir os bidês quando aplicadas junto da sanita.

Podem ser ligadas a um ponto de água com torneira de esquadria e funcionar inclusive com 2 águas quando é aplicada uma válvula misturadora antes da ducheta. Existem ainda aplicações alternativas, como seja, por exemplo, a aplicação em pet shops ou locais semelhantes para a higiene do seu animal de estimação.

Máxima higiene e conforto num modelo que se destaca pela excelência do seu desempenho.



### DUCHETA CROMADA

REF.	DESCRIÇÃO			
BK5012001	KIT DUCHETA	1	40	
BK5012201	DUCHETA	5	100	
BK5012401	SUPORTE	5	100	
BK5012601	BICHA - 125 cm	10	100	



# Ducheta branca

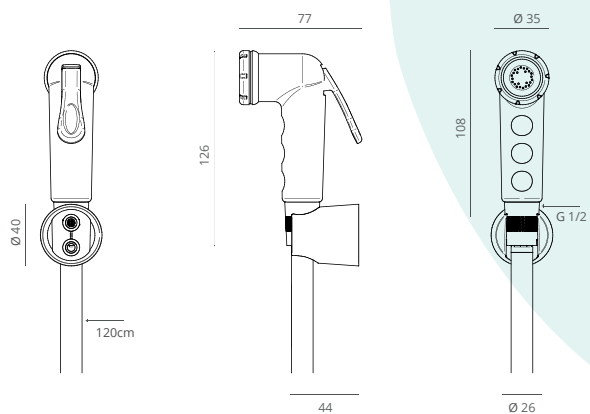

## DUCHETA BRANCA

REF.	DESCRIÇÃO			
BK5012000	KIT DUCHETA	1	40	
BK5012200	DUCHETA	5	100	
BK5012400	SUPORTE	5	100	
BK5012600	BICHA - 120 cm	10	100	



# Tampas para sifão



## EXPANSÃO INOX AISI 304

REF.	MEDIDAS			
BK2010600	Ø90mm	1	60	
BK2010601	Ø110mm	1	50	
BK2010602	Ø125mm	1	30	

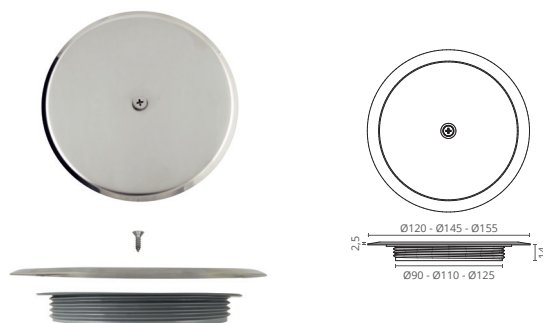

## AÇO INOX POLIDO AISI 304

REF.	MEDIDAS			
BK2010200	Ø90 mm	1	100	
BK2010201	Ø110 mm	1	50	
BK2010202	Ø125 mm	1	30	



## ABS

REF.	MEDIDAS			
BK2010000	Ø90 mm	1	250	
BK2010001	Ø110 mm	1	200	
BK2010002	Ø125 mm	1	150	

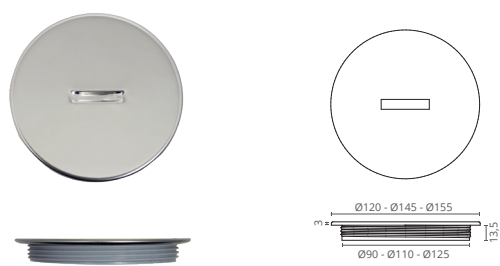

## AÇO INOX AISI 304

REF.	MEDIDAS			
BK2010100	Ø90 mm	1	150	
BK2010101	Ø110 mm	1	50	
BK2010102	Ø125 mm	1	40	

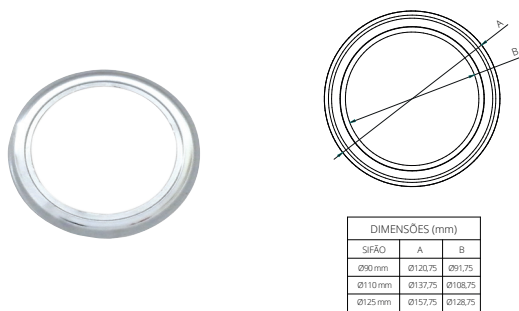

## ABS

### AROS P/ SIFÃO

REF.	MEDIDAS			
BK2011000	Ø90 mm	1	250	
BK2011001	Ø110 mm	1	200	
BK2011002	Ø125 mm	1	160	

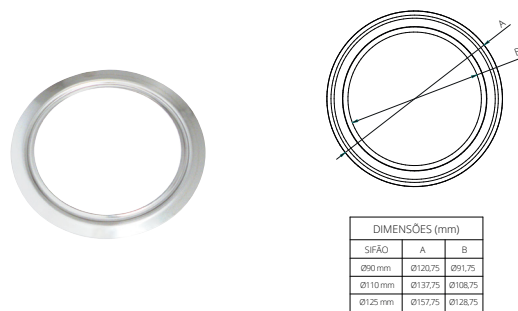

## AÇO INOX AISI 304

### AROS P/ SIFÃO

REF.	MEDIDAS			
BK2011100	Ø90 mm	1	250	
BK2011101	Ø110 mm	1	150	
BK2011102	Ø125 mm	1	250	



## PERSIANA BRANCO

REF.	MEDIDAS			
BK2008000	12 x 12 cm	10	25	
BK2008005	15 x 15 cm	10	25	
BK2008010	20 x 20 cm	10	50	



## PERSIANA BRANCO

REF.	MEDIDAS			
BK2008020	25 x 25 cm	10	30	
BK2008030	30 x 30 cm	10	30	
BK2008040	40 x 40 cm	10	15	



## C/ REGULADOR GIRATÓRIO BRANCO

REF.	MEDIDAS			
BK2008200	12 x 12 cm	10	60	
BK2008205	15 x 15 cm	10	50	



## C/ REGULADOR GIRATÓRIO BRANCO

REF.	MEDIDAS			
BK2008300	Ø 12 cm	10	40	
BK2008305	Ø 14 cm	10	25	



## PERSIANA RECTANGULAR BRANCO

REF.	MEDIDAS			
BK2008015	25 x 10 cm	-	10	



## PERSIANA RECTANGULAR BRANCO

REF.	MEDIDAS			
BK2008025	30 x 15 cm	10	30	
BK2008035	40 x 20 cm	10	40	

# Sifões lava-louças

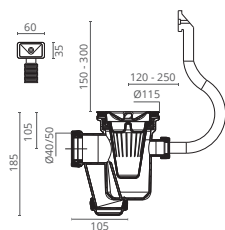

## SIFÃO GORDURA C/ AVISADOR

REF.	MODELO			
BK2012505	Ø115 x 40/50 - CAIXA	5	14	

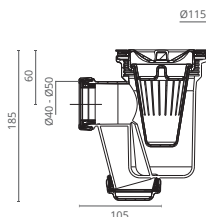

## SIFÃO GORDURA

REF.	MODELO			
BK2012500	Ø115 x 40/50 - CAIXA	5	14	

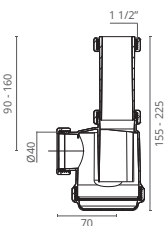

## SIFÃO SIMPLE S/ VÁLVULAS

REF.	MODELO			
BK2012000	SS-01	5	70	

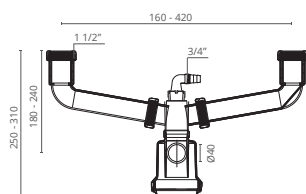

## SIFÃO DUPLO S/ VÁLVULAS

REF.	MODELO			
BK2012200	SD-01	5	25	

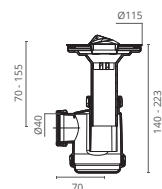

## SIFÃO SIMPLE C/ VÁLVULAS

REF.	MODELO			
BK2012010	SS-02	5	50	

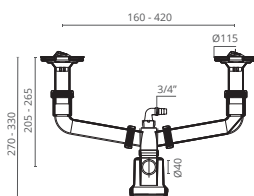

## SIFÃO DUPLO C/ VÁLVULAS

REF.	MODELO			
BK2012210	SS-02	5	18	

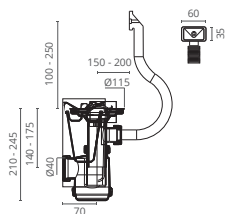

**SIMPLES C/ VÁLVULA C/ AVISADOR**

REF.	MODELO			
BK2012020	SS-03	5	36	

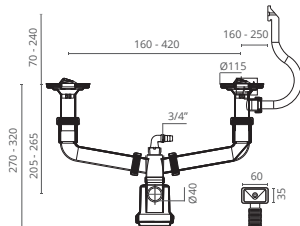

**DUPLO C/ VÁLVULAS E AVISADOR**

REF.	MODELO			
BK2012220	SD-03	5	15	

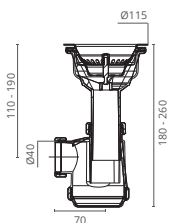

**SIMPLES C/ VÁLVULA CESTO**

REF.	MODELO			
BK2012030	SS-05	5	35	

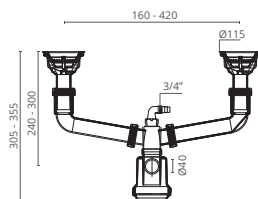

**DUPLO C/ VÁLVULAS CESTO**

REF.	MODELO			
BK2012230	SD-05	5	15	

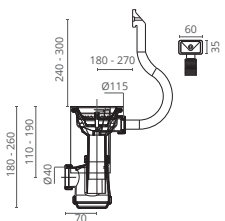

**SIMPLES C/ VÁLVULA CESTO E AVISADOR**

REF.	MODELO			
BK2012040	SS-06	5	30	

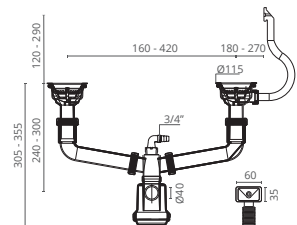

**DUPLO C/ VÁLVULAS CESTO E AVISADOR**

REF.	MODELO			
BK2012240	SD-06	5	14	

# Acessórios

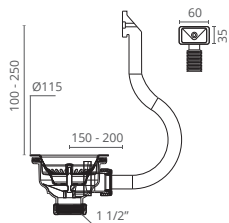

VÁLVULA C/ CESTO INOX E AVISADOR

REF.	MODELO			
BK2013220	Ø115 VC-02	5	30	

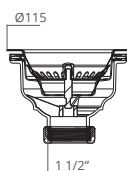

VÁLVULA C/ CESTO INOX

REF.	MODELO			
BK2013210	Ø115 VC-01	5	50	

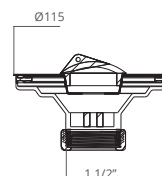

VÁLVULA SIMPLES

REF.	MODELO			
BK2013200	Ø115 VS-01	5	70	

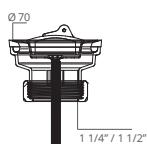

VÁLVULA LAVATÓRIO

REF.	MODELO			
BK2013010	1.1/4\" VL-01	5	130	
BK2013020	1.1/2\" VL-02	5	85	

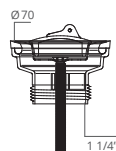

VÁLVULA ROSCADA

REF.	MODELO			
BK2013030	1.1/4\" VL-03	5	100	

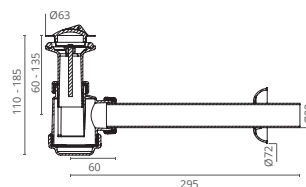

SIFÃO GARRAFA LAVATÓRIO

REF.	MODELO			
BK2013000	1.1/4\" SL-01	1	30	



CESTO INOX

REF.	MEDIDAS			
BK2013290	Ø115	5	200	



TACO 43 mm

REF.	COR			
BK2013905	PRETO	10	650	



TACO LAVATÓRIO 38 mm

REF.	COR			
BK2013900	PRETO	10	1000	

# Acessórios máquina de lavar

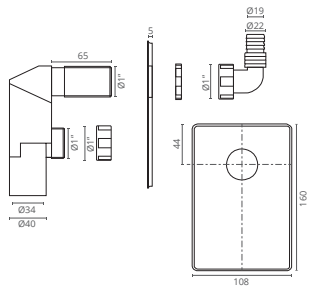

## SIFÃO INTERIOR CROMADO

REF.	MEDIDAS			
BK2004000	Ø40 x 18/24 mm	5	50	



A

B

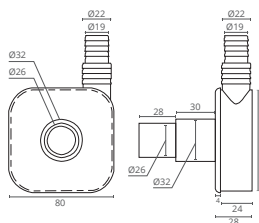

## SIFÃO EXTERIOR

REF.	MEDIDAS	COR			
A BK2004020	Ø32 X 26 mm		1	50	
B BK2004021	Ø32 X 26 mm		1	50	

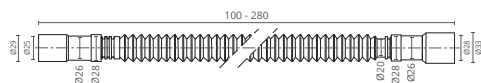

## TUBO DESCARGA EXTENSÍVEL

REF.	MEDIDAS			
BK2004100	1,00 - 2,8 m	1	100	



## TUBO DESCARGA

REF.	MEDIDAS			
BK2004121	1,50 m	1	50	
BK2004122	2,00 m	1	50	
BK2004124	3,00 m	1	50	

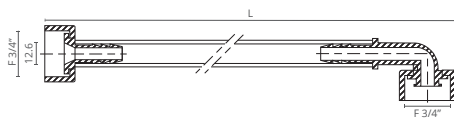

## BICHAS CARGA

REF.	MEDIDAS			
BK2004200	1,50 m	1	50	
BK2004202	2,00 m	1	50	
BK2004203	2,50 m	1	50	



# 02

## tampos de sanita

A Ctesi apresenta-lhe uma variada gama de tampos de sanita em diferentes estilos e materiais como o polipropileno, MDF ou duraplast.

Todos os nossos tampos são produzidos de acordo com os mais rigorosos testes de qualidade.

De fácil instalação, as ferragens utilizadas para estes tampos são de alta qualidade, permitindo uma simples instalação, mas também uma durabilidade comprovada.

As qualidades dos tampos de sanita Ctesi comprovam-se não apenas pelos seus materiais de primeira linha, mas também pela elegância e conforto que conferem à sua sanita.

Qualidade, desempenho e alta durabilidade são sinónimos de tampos de sanita Ctesi.





# Polipropileno

## Versátil, elevada resistência e grande durabilidade

Polipropileno (PP) é um material muito versátil de elevada resistência química e a solventes, de fácil modelação e óptima resistência ao impacto enquanto garante uma grande durabilidade.

Permite obter um óptimo compromisso entre a rigidez e a resistência ao impacto.

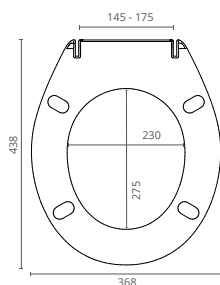
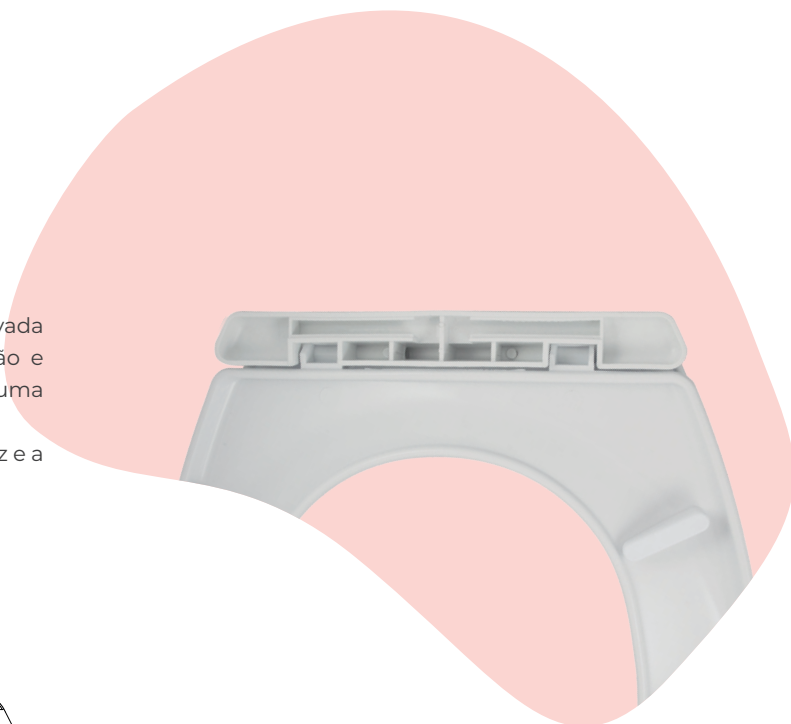

#### COMPATIBILIDADES:

EUROPA, MUNIQUE, ESTACO, MONTEROSA, NEOCLÁSSICA, LISBOA, ALGARVE, ALVOR

#### ÍLHAVO

REF.	COR			
BK3000000	BRANCO	6	12	

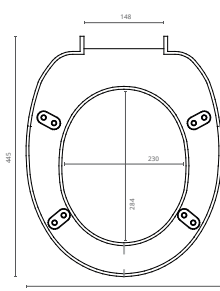

#### COMPATIBILIDADES:

APOLO, ALVOR, ITÁLIA, VITÓRIA, MONTEROSA, NEOCLÁSSICA, RUBI, IMPERIAL, ESTACO, MUNIQUE

#### EQUADOR

REF.	COR			
BK3000020	BRANCO	5	10	

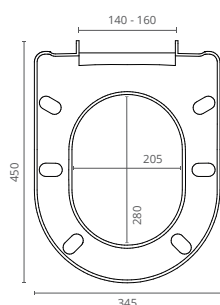

#### COMPATIBILIDADES:

ÁQUA, AVEIRO, CONDOR, DAMA, IMAGE, EDEN, MERIDIAN, PRESTIGE, REGINA, THEMA

#### LUGO

REF.	COR			
BK3000040	BRANCO	5	10	

## Muito resistente a abrasão e a químicos

É composto por material reciclado, desperdícios de algodão e resinas fenólicas, reforçado com fibras de algodão ou lã, tornando-se um plástico semelhante à fibra de vidro e com um aspecto idêntico ao da cerâmica.

Resistente a choques | Material antibacteriano | Facilidade de limpeza

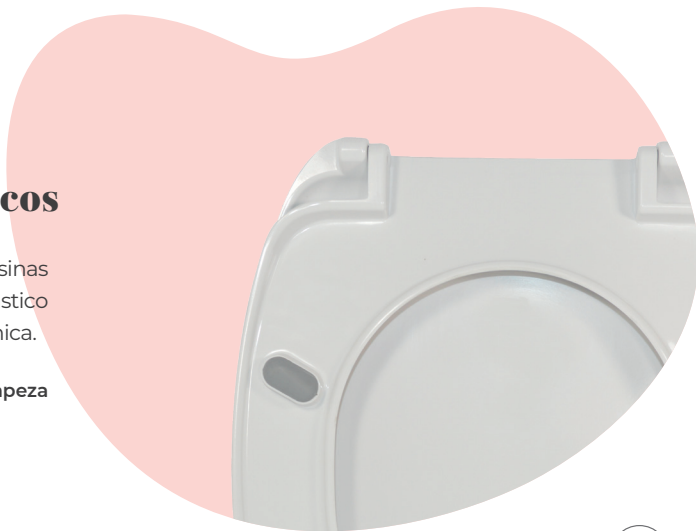

### COMPATIBILIDADES:

EUROPA, ITÁLIA, MUNIQUE, ESTACO, MADALENA, APOLO, NEOCLÁSSICA, MONTEROSA, LUNA, VITÓRIA, ALVOR, LISBOA, ALGARVE, RUBI

### HERA

REF.	COR			
BK3002060	BRANCO	1	10	

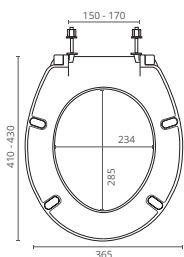

### COMPATIBILIDADES:

ALFA, ALFA PLUS, OCEANUS, EROS

### EDNA

REF.	COR			
BK3002080	BRANCO	1	5	

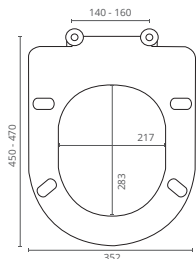

### COMPATIBILIDADES:

REGINA, ATLANTA, STYLO, MERIDIAN, FLORENÇA, NEXO, AVEIRO, AQUA, CONDOR, IMAGE, MIMOSA, OCEANUS, PRESTIGE, DANUBIO, ESTORIL, PROJET, SIRIUS, URBYT

### MUSA

REF.	COR			
BK3002020	BRANCO	1	5	

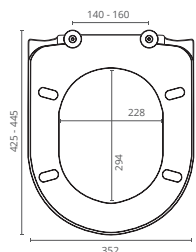

### COMPATIBILIDADES:

INGLÊS, RUBI, ESTACO, ALGARVE, APOLO, CONCHA, CONCRETA, ITÁLIA, LUNAR, MUNIQUE, MUNIQUE PLUS, MONTEROSA, MADALENA, SUPERBUS, SACAVÉM, VITÓRIA, POLO ZOOM, CETUS, EUROPA, HELIA, LISBOA

### DÓRIS

REF.	COR			
BK3002000	BRANCO	1	5	

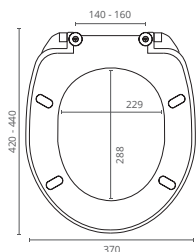

### COMPATIBILIDADES:

ARIES, CONCORDE, CALYPSO, VENEZA, GÔNDOLA

### ARIA

REF.	COR			
BK3002040	BRANCO	1	5	

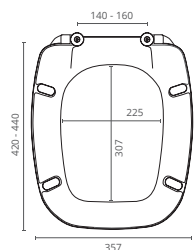

# Duroplast soft-close

Os tampos de sanita **Leto**, **Memphis**, **Gap**, **Vitoria**, **Thin** e **Sublime** são construídos em Duroplast, um material de elevada resistência no qual se adicionam na sua construção partículas com propriedades anti-bacterianas, maximizando assim a limpeza e higiene em tampos de sanita que se apresentam com um aspecto brilhante ímpar.



## Fácil instalação

As ferragens que equipam esta gama de tampos de sanita destacam-se pela robustez e simplicidade de instalação. Aplique em primeiro lugar as ferragens sem a necessidade de ter o tampo acoplado e só após aplique facilmente o tampo sobre as ferragens que o fixam à sanita.



## Fácil desmontagem para limpeza

O novo sistema incorporado no tampo com botão de fácil pressão para retirar o tampo, facilita as operações de instalação e remoção para limpeza que pode ser feita facilmente por qualquer pessoa.



## Fecho amortecido

O fecho amortecido "Soft Close" que equipa esta gama de tampos de sanita suaviza o fecho do tampo, conferindo desta forma um maior conforto e segurança no seu uso diário.



### COMPATIBILIDADES:

INGLÊS, RUBI, ESTACO, ALGARVE, APOLO, CONCHA, CONCRETA, ITÁLIA, LUNAR, MUNIQUE, MUNIQUE PLUS, MONTEROSA, MADALENA, SUPERBUS, SACA VÉM, VITÓRIA, POLO ZOOM, CETUS, EUROPA, HELIA, LISBOA

### LETO

REF.	COR			
BK3004020	BRANCO	1	5	

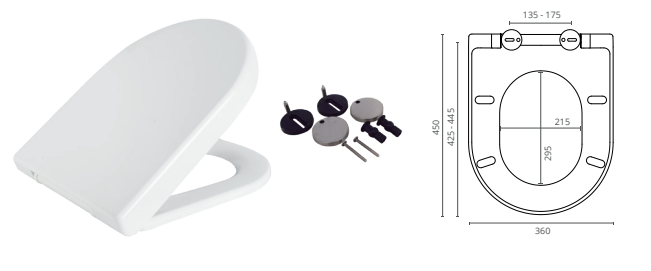

### COMPATIBILIDADES:

STYLO, MERIDIAN, FLORENÇA, AVEIRO, AQUA, CONDOR, IMAGE, MIMOSA, OCEANUS, PRESTIGE, PROJET, EROS, SIRIUS, URBY, NEXO

### MEMPHIS

REF.	COR			
BK3004060	BRANCO	1	5	



### GAP

REF.	COR			
BK3004050	BRANCO	1	5	



### VITORIA

REF.	COR			
BK3004030	BRANCO	1	5	



# Duroplast Slim com soft-close



## Resistência concentrada

Os tampos de sanita Sublime e Thin são construídos em duroplast, um plástico de elevada resistência e solidez e que se apresenta no seu máximo esplendor devido à reduzida espessura de cada conjunto.

## Máximo conforto e elegância

Assim, concentramos em apenas 21 mm de espessura toda a resistência deste plástico reforçado com fibra e que termina com um acabamento brilhante e sublime. Com os tampos de sanita em Duroplast slim desfrute com o máximo conforto deste material antibacteriano num design de extrema elegância.

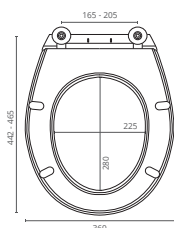

### COMPATIBILIDADES:

INGLÊS, RUBI, ESTACO, ALGARVE, APOLO, CONCHA, CONCRETA, ITÁLIA, LUNAR, MUNIQUE, MUNIQUE PLUS, MONTEROSA, MADALENA, SUPERBUS, SACAVÉM, VITÓRIA, POLO ZOOM, CETUS, EUROPA, HELIA, LISBOA

### SUBLIME

REF.	COR			
BK3005000	BRANCO	1	5	

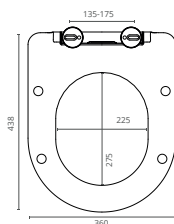

### COMPATIBILIDADES:

REGINA, ATLANTA, STYLO, MERIDIAN, FLORENÇA, ALFA, ALFA PLUS, NEXO, AVEIRO, AQUA, CONDOR, DAMA, IMAGE, JADE, MIMOSA, OCEANUS, PRESTIGE, DANUBIO, ESTORIL, ELEGANCE, THEMA, PROJET, EROS, SIRIUS, URBY

### THIN

REF.	COR			
BK3005020	BRANCO	1	5	



# MDF ou Contraplacado marítimo

## Personalização

### tampos de sanita em MDF ou contraplacado marítimo

Os tampos de sanita em MDF ou Contraplacado Marítimo Ctesi® são fabricados à medida das suas necessidades e por isso adaptam-se a qualquer modelo de sanita. Oferecem-lhe uma sensação mais quente e proporcionam um estilo natural ao seu espaço de banho.

Além das clássicas tampas brancas, poderá encontrar uma vasta gama de modelos de diferentes cores e acabamentos, como por exemplo, os acabamentos em madeira natural como o Wenguê, a Cerejeira ou a madeira natural em tons de bege, castanho ou ainda os acabamentos Premium sobre contraplacado marítimo como a Cortiça, a folha de Ébano Natural ou Cracklé. Além disso, toda a carta de cores sólidas RAL® está disponível, pelo que o leque de cores disponíveis é infinito.

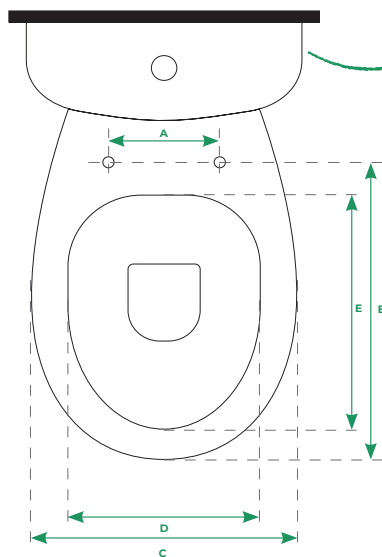

Se não sabe qual é o modelo exato da sua sanita, envie-nos uma foto e nós indicaremos qual o tampo adequado.

É importante que nos envie as **medidas da sanita** para que a tampa se adapte perfeitamente à sua casa de banho.

#### LEGENDA

- A** - Distância entre os centros das furações da sanita
- B** - Distância entre o centro das furações da sanita até à parte frontal da sanita
- C** - Largura máxima da sanita
- D** - Largura interior da sanita
- E** - Profundidade interior da sanita

Qualquer  
modelo

Qualquer  
medida

Obtenha o formulário para pedido de cotação e/ou encomenda, junto de um dos nossos parceiros ou directamente connosco para o e-mail: [geral@barros-moreira.pt](mailto:geral@barros-moreira.pt)



### madeira natural

A alta densidade da madeira torna-a adequada para um tampo de sanita enquanto a sensação quente ao toque lhe proporciona o conforto desejado.

Os tampos de sanita em MDF lacados ou em Contraplacado Marítimo com velatura são acabados com tinta ecológica, resultando num nobre acabamento. Na Ctesi®, usamos madeiras provenientes de florestas bem geridas e com elevados níveis de sustentabilidade, de acordo com as melhores práticas ambientais, económicas e sociais.

# MDF Universais

## MDF oferece um estilo mais natural à casa de banho

Um derivado da madeira e excelente substituto da mesma. Com um acabamento uniforme, não apresenta veios ou outras irregularidades da madeira. Com alta densidade, é resistente, estável, plano e permite distintos acabamentos do tipo lacado de alto brilho.

Resistente a choques | Material antibacteriano | Facilidade de limpeza

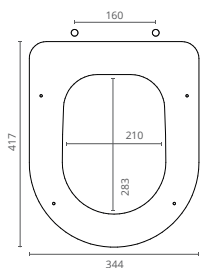

DOBRADIÇA



FIXAÇÃO

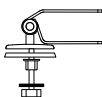

### COMPATIBILIDADES:

ÁQUA, AVEIRO, CONDOR, ESTORIL, IMAGE, REGINA, THEMA, DANÚBIO, DELTA, ELEGANCE, OCEANUS, FLORENÇA, JADE

### VÊNUS

REF.	COR			
BK3018000	BRANCO	1	5	

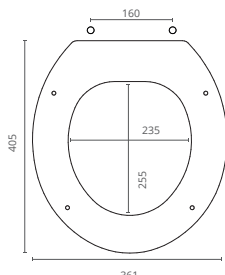

DOBRADIÇA



FIXAÇÃO

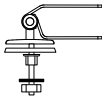

### COMPATIBILIDADES:

EUROPA, ITÁLIA, MUNIQUE, ESTACO, MADALENA, APOLO, NEOCLÁSSICA, MONTEROSA, LUNA, VITÓRIA, ALVOR, LISBOA, ALGARVE, RUBI

### AFRODITE

REF.	COR			
BK3018600	BRANCO	1	5	

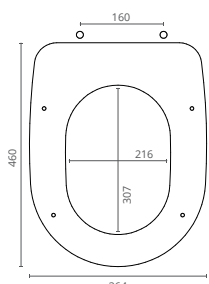

DOBRADIÇA



FIXAÇÃO

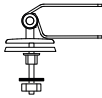

### COMPATIBILIDADES:

ALFA, DAMA, MERIDIAN, PRESTIGE

### ZEUS

REF.	COR			
BK3018200	BRANCO	1	5	

# MDF

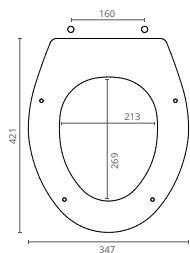

SOFT-CLOSE:

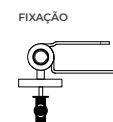
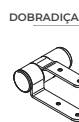

## EUROPA

SEM SOFT-CLOSE		COM SOFT-CLOSE		COR			
REF.	REF.	REF.	REF.				
BK3010000	BK3010005			BRANCO		1	5

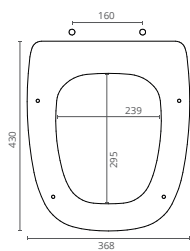

SOFT-CLOSE:



## VENEZA

SEM SOFT-CLOSE		COM SOFT-CLOSE		COR			
REF.	REF.	REF.	REF.				
BK3010200	BK3010205			BRANCO		1	5

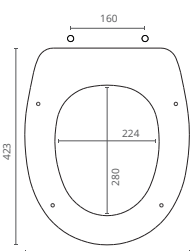

SOFT-CLOSE:

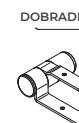

## MUNIQUE

SEM SOFT-CLOSE		COM SOFT-CLOSE		COR			
REF.	REF.	REF.	REF.				
BK3010400	BK3010405			BRANCO		1	5

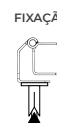
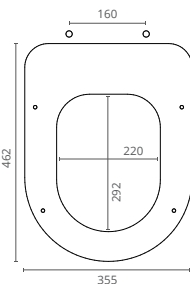

SOFT-CLOSE:

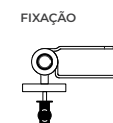

## ALFA

SEM SOFT-CLOSE		COM SOFT-CLOSE		COR			
REF.	REF.	REF.	REF.				
BK3010600	BK3010605			BRANCO		1	5

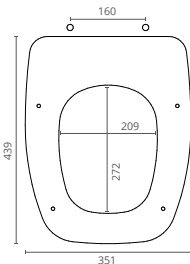

SOFT-CLOSE:



## CONCORDE

SEM SOFT-CLOSE		COM SOFT-CLOSE		COR			
REF.	REF.	REF.	REF.				
BK3010800	BK3010805			BRANCO		1	5

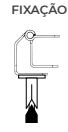
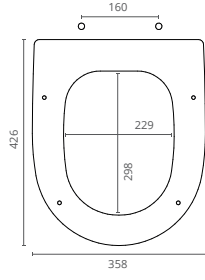

SOFT-CLOSE:

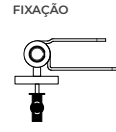
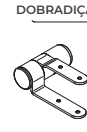

**AVEIRO**

SEM SOFT-CLOSE	COM SOFT-CLOSE	COR			
REF.	REF.				
BK3011000	BK3011005	BRANCO	1	5	

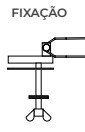
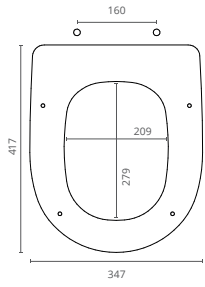

SOFT-CLOSE:

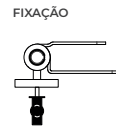
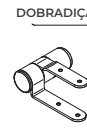

**REGINA**

SEM SOFT-CLOSE	COM SOFT-CLOSE	COR			
REF.	REF.				
BK3011200	BK3011205	BRANCO	1	5	

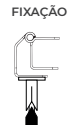
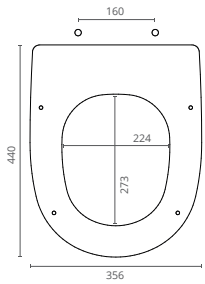

SOFT-CLOSE:

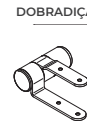

**ESTORIL**

SEM SOFT-CLOSE	COM SOFT-CLOSE	COR			
REF.	REF.				
BK3011400	BK3011405	BRANCO	1	5	

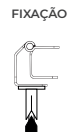
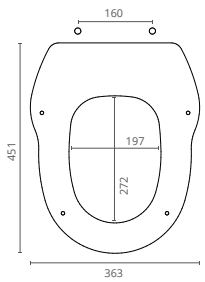

SOFT-CLOSE:

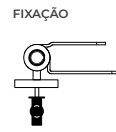
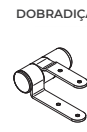

**GRÉCIA**

SEM SOFT-CLOSE	COM SOFT-CLOSE	COR			
REF.	REF.				
BK3011600	BK3011605	BRANCO	1	5	

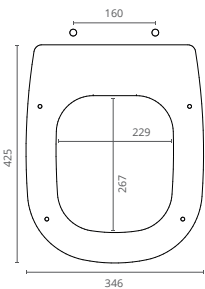

SOFT-CLOSE:

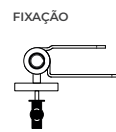
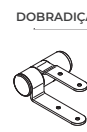

**EDEN**

SEM SOFT-CLOSE	COM SOFT-CLOSE	COR			
REF.	REF.				
BK3011800	BK3011805	BRANCO	1	5	

# MDF

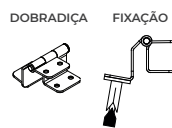
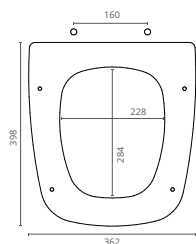

## COLÓNIA

SEM SOFT-CLOSE		COR		
REF.				
BK3012400		BRANCO	1	5

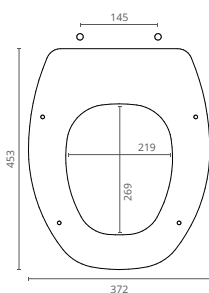

## MONTEBIANCO

SEM SOFT-CLOSE		COM SOFT-CLOSE		COR		
REF.	REF.					
BK3012200	BK3012205			BRANCO	1	5

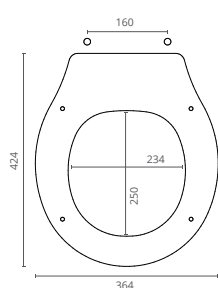

## NEOCLÁSSICA

SEM SOFT-CLOSE		COM SOFT-CLOSE		COR		
REF.	REF.					
BK3012600	BK3012605			BRANCO	1	5

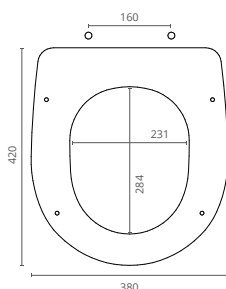

## IMAGE

SEM SOFT-CLOSE		COM SOFT-CLOSE		COR		
REF.	REF.					
BK3012000	BK3012005			BRANCO	1	5

# Contraplacado marítimo

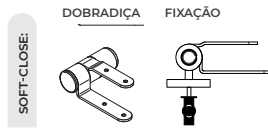
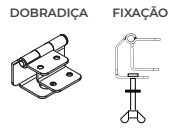
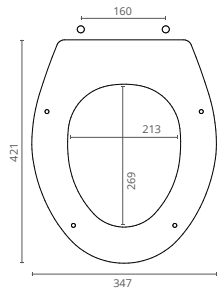

## EUROPA

SEM SOFT-CLOSE		COM SOFT-CLOSE		COR	
REF.	REF.				
BK3020000	BK3020005	BRANCO	1	5	

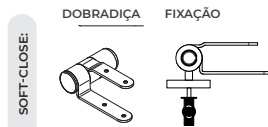
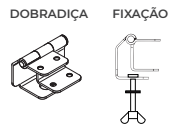
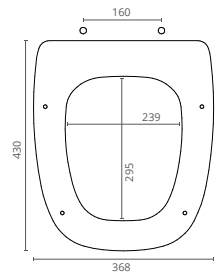

## VENEZA

SEM SOFT-CLOSE		COM SOFT-CLOSE		COR	
REF.	REF.				
BK3020200	BK3020205	BRANCO	1	5	

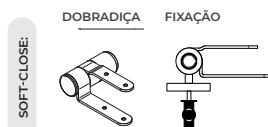
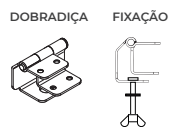
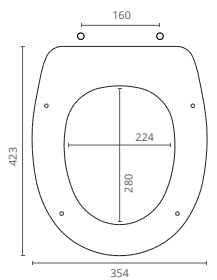

## MUNIQUE

SEM SOFT-CLOSE		COM SOFT-CLOSE		COR	
REF.	REF.				
BK3020400	BK3020405	BRANCO	1	5	

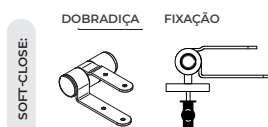
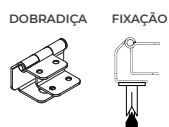
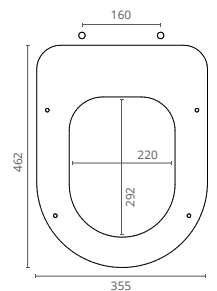

## ALFA

SEM SOFT-CLOSE		COM SOFT-CLOSE		COR	
REF.	REF.				
BK3020600	BK3020605	BRANCO	1	5	



# Contraplacado marítimo

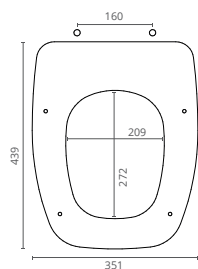

DOBRADIÇA



FIXAÇÃO



SOFT-CLOSE:

DOBRADIÇA



FIXAÇÃO

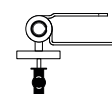

## CONCORDE

SEM SOFT-CLOSE		COM SOFT-CLOSE		COR			
REF.	REF.	REF.	REF.	REF.	REF.	REF.	REF.
BK3020800	BK3020805			BRANCO	1		5

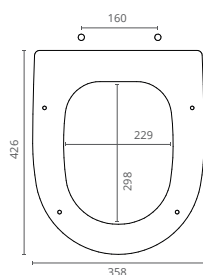

DOBRADIÇA



FIXAÇÃO



SOFT-CLOSE:

DOBRADIÇA



FIXAÇÃO

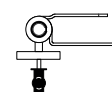

## AVEIRO

SEM SOFT-CLOSE		COM SOFT-CLOSE		COR			
REF.	REF.	REF.	REF.	REF.	REF.	REF.	REF.
BK3021000	BK3021005			BRANCO	1		5

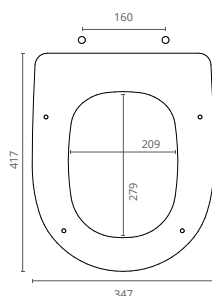

DOBRADIÇA



FIXAÇÃO



SOFT-CLOSE:

DOBRADIÇA



FIXAÇÃO

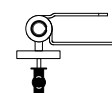

## REGINA

SEM SOFT-CLOSE		COM SOFT-CLOSE		COR LACADA OU MADEIRA			
REF.	REF.	REF.	REF.	REF.	REF.	REF.	REF.
BK3021200	BK3021205			BRANCO	1		5

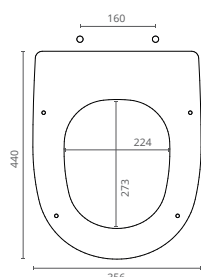

DOBRADIÇA



FIXAÇÃO



SOFT-CLOSE:

DOBRADIÇA



FIXAÇÃO

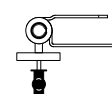

## ESTORIL

SEM SOFT-CLOSE		COM SOFT-CLOSE		COR LACADA OU MADEIRA			
REF.	REF.	REF.	REF.	REF.	REF.	REF.	REF.
BK3021400	BK3021405			BRANCO	1		5

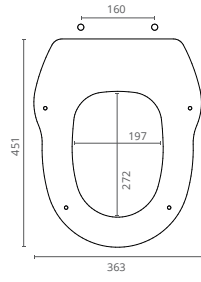

**GRÉCIA**

SEM SOFT-CLOSE REF.	COM SOFT-CLOSE REF.	COR LACADA OU MADEIRA			
BK3021600	BK3021605	BRANCO	1	5	

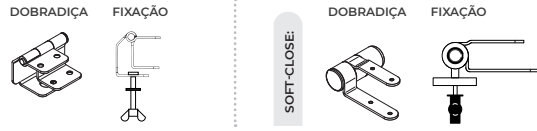
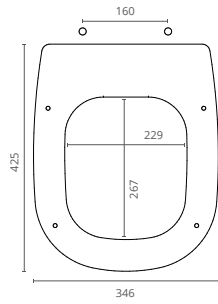

**EDEN**

SEM SOFT-CLOSE REF.	COM SOFT-CLOSE REF.	COR LACADA OU MADEIRA			
BK3021800	BK3021805	BRANCO	1	5	

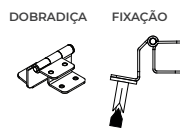
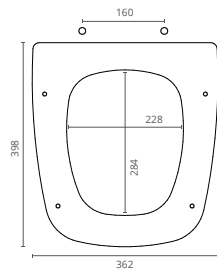

**COLÓNIA**

SEM SOFT-CLOSE REF.	COR			
BK3022400	BRANCO	1	5	

# Contraplacado marítimo

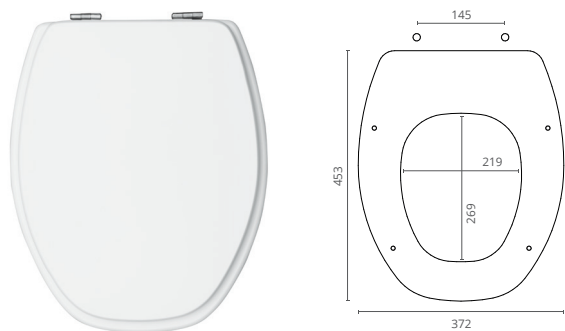

## MONTEBIANCO

SEM SOFT-CLOSE	COM SOFT-CLOSE	COR LACADA OU MADEIRA	1	5
REF.	REF.			
BK3022200	BK3022205	BRANCO		

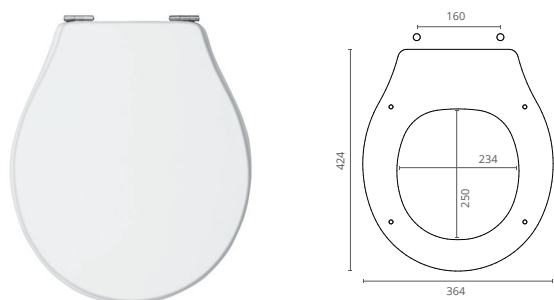

## NEOCLÁSSICA

SEM SOFT-CLOSE	COM SOFT-CLOSE	COR LACADA OU MADEIRA	1	5
REF.	REF.			
BK3022600	BK3022605	BRANCO		

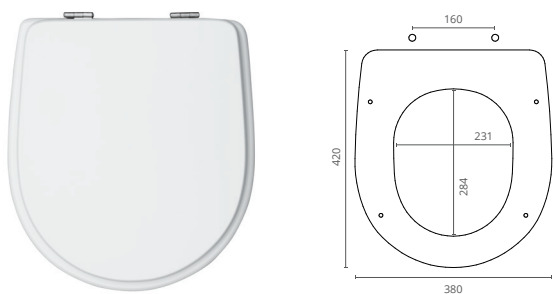

## IMAGE

SEM SOFT-CLOSE	COM SOFT-CLOSE	COR LACADA OU MADEIRA	1	5
REF.	REF.			
BK3022000	BK3022005	BRANCO		

# Acessórios tampos de sanita



POLIPROPILENO

ILHAVO

REF.

BK3018000



1



POLIPROPILENO

EQUADOR / LUGO

REF.

BK3090020



1



POLIPROPILENO

LETO / MEMPHIS / VITORIA / GAP / THIN / SUBLIME

REF.

BK3090260



1



MDF / CM

CONCORDE / IMAGE / VENEZA

REF.

BK3090310



1



MDF / CM

REGINA

REF.

BK3090320



1



MDF / CM

COLÓNIA

REF.

BK3090330



1



MDF / CM

AFRODITE / VÊNUS / ZEUS

REF.

BK3090300



1



MDF / CM

ALFA / ESTORIL

REF.

BK3090340



1

# 03

## acessórios

Elementos fundamentais par o bom funcionamento de qualquer casa de banho, os acessórios e sistemas da marca Ctesi são concebidos de modo a garantir durabilidade e eficiência ao longo do tempo de vida da sua utilização.

Desde elementos simples como válvulas ou tampões, até os perlatores economizadores, que permitem uma efetiva poupança de água.

Todos estes produtos são de excelente qualidade, garantindo uma fácil aplicação e uma longa durabilidade.

Aposte na qualidade dos produtos da sua casa de banho, aposte nos produtos da marca Ctesi.







# Torneiras esquadria

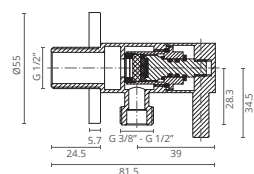

## CILÍNDRICA

REF.	MEDIDAS			
CT2262020	1/2" x 3/8"	5	100	
CT2262021	1/2" x 1/2"	5	100	
CT2262055	1/2" x 1/2" - PRETO	5	100	

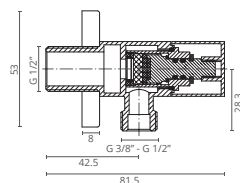

## QUADRADA

REF.	MEDIDAS			
CT2262040	1/2" x 3/8"	5	100	
CT2262041	1/2" x 1/2"	5	100	
CT2262075	1/2" x 1/2" - PRETO	5	100	

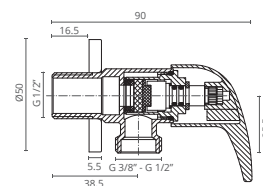

## MONOCOMANDO

REF.	MEDIDAS			
CT2262000	1/2" x 3/8"	5	100	
CT2262001	1/2" x 1/2"	5	100	

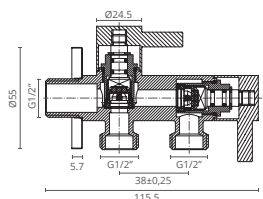

## CILÍNDRICA DUPLA

REF.	MEDIDAS			
CT2262220	1/2" x 1/2" x 1/2"	5	50	

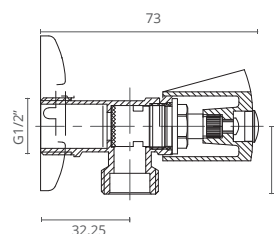

## QUICK

REF.	MEDIDAS			
5032402	1/2" x 1/2"	10	50	

# Torneiras esquadria

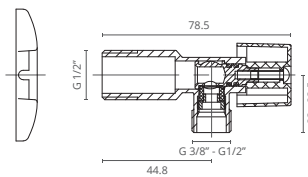

## NORMAL

REF.	MEDIDAS			
5032020	1/2" x 3/8"	20	100	
5032021	1/2" x 1/2"	20	100	

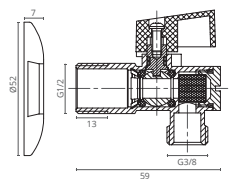

## MINI C/ FILTRO

REF.	MEDIDAS			
5034210	1/2" x 3/8"	20	100	
5034211	1/2" x 1/2"	20	100	

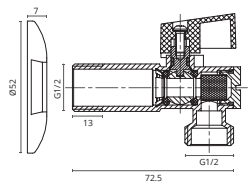

## LONGA C/ FILTRO

REF.	MEDIDAS			
5034401	1/2" x 3/8"	20	100	
5034402	1/2" x 1/2"	20	100	
5034402	1/2" x 3/4"	20	100	

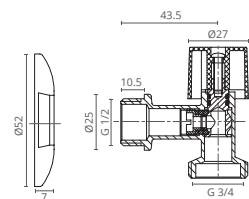

## MÁQUINA DE LAVAR

REF.	MEDIDAS			
5032022	1/2" x 3/4"	10	100	

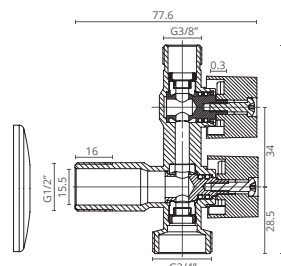

## DUPLA

REF.	MEDIDAS			
5032300	1/2" x 3/4" x 3/8"	10	50	

**A** CONTROLO SAÍDA 3/4"    **B** CONTROLO SAÍDA 3/8"

# Válvulas de lavatório

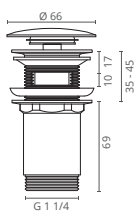

**CLICK CLACK**  
VÁLVULA LAVATÓRIO GRANDE

REF.	MEDIDAS			
CT2100010	1,1/4"	1	50	

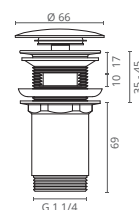

**CLICK CLACK**  
VÁLVULA LAVATÓRIO GRANDE PRETA

REF.	MEDIDAS			
CT2100012	1,1/4"	1	50	

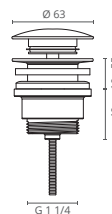

**CLICK CLACK**  
VÁLVULA LAVATÓRIO C/ PARAFUSO

REF.	MEDIDAS			
CT2100040	1,1/4"	1	50	

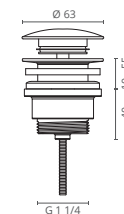

**CLICK CLACK**  
VÁLVULA LAVATÓRIO C/ PARAFUSO PRETA

REF.	MEDIDAS			
CT2100045	1,1/4"	1	50	

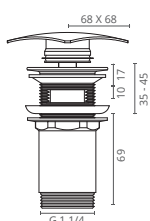

**CLICK CLACK**  
VÁLVULA LAVATÓRIO QUADRADA

REF.	MEDIDAS			
CT2100020	1,1/4"	1	50	

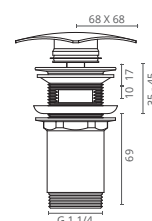

**CLICK CLACK**  
VÁLVULA LAVATÓRIO QUADRADA PRETA

REF.	MEDIDAS			
CT2100022	1,1/4"	1	50	

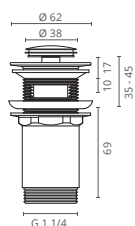

**CLICK CLACK**  
VÁLVULA LAVATÓRIO

REF.	MEDIDAS			
CT2100000	1,1/4"	10	100	

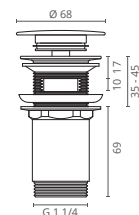

**CLICK CLACK**  
VÁLVULA LAVATÓRIO PLANA

REF.	MEDIDAS			
CT2100030	1,1/4"	10	50	

# Sifões de lavatório



## LINEA

REF.	MEDIDAS			
CT2102000	TUBO 30 cm	1	20	

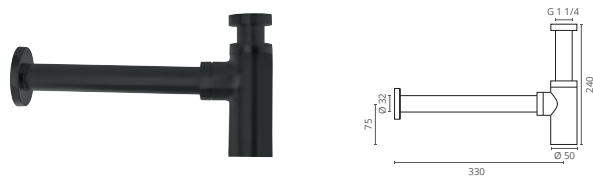

## LINEA - PRETO

REF.	MEDIDAS			
CT2102002	TUBO 30 cm	1	20	

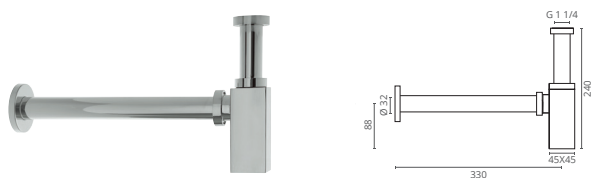

## QUADRO

REF.	MEDIDAS			
CT2102030	TUBO 30 cm	1	20	

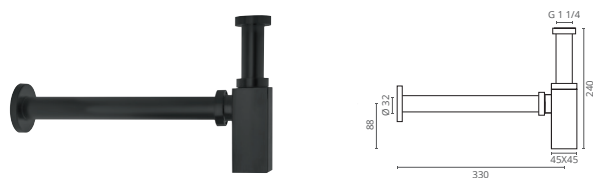

## QUADRO - PRETO

REF.	MEDIDAS			
CT2102032	TUBO 30 cm	1	20	



## GARRAFA

REF.	MEDIDAS			
CT2102101	TUBO 30 cm	1	20	



## TUBO FLEXIVEL

REF.	MEDIDAS			
CT2102520	Ø32 x 30 cm	1	-	



## TUBO SIMPLES

REF.	MEDIDAS			
CT2102501	Ø32 x 30 cm	1	-	



## TUBO SIMPLES C/ ABA

REF.	MEDIDAS			
CT2102541	Ø32 x 30 cm	1	-	
CT2102543	Ø32 x 40 cm	1	-	
CT2102544	Ø32 x 50 cm	1	-	

# Válvulas de banheira

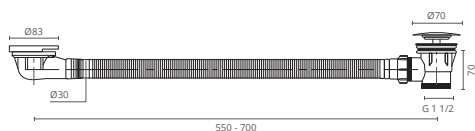

CLICK CLACK PVC

REF.	MEDIDAS			
CT2100250	1.1/2" x 40	1	20	

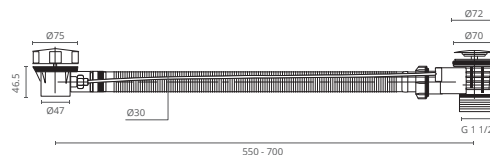

AUTOMÁTICA PVC

REF.	MEDIDAS			
CT2100260	1.1/2" x 40	1	20	

# Acessórios para válvulas



TAMPÃO P/ VÁLVULA CLICK CLACK

REF.	MODELO	MATERIAL			
CT2260380	CLICK CLACK	LATÃO	1	-	
CT2260381	CLICK CLACK GRANDE	LATÃO	1	-	

TAMPÃO P/ VÁLVULA CLICK CLACK

REF.	MODELO	MATERIAL			
CT2260382	CLICK CLACK QUADRADA	LATÃO	1	-	



VEDANTE P/ TAMPÃO

REF.	MODELO			
CT2260390	CLICK CLACK	10	-	

KIT 3 VEDANTES P/ VÁLVULA CLICK

REF.	MODELO			
CT2260398	CLICK CLACK	1	-	

MOLA P/ VÁLVULA CLICK CLACK

REF.	MODELO			
CT2260385	LATÃO	1	-	

# Bichas de chuveiro

## sistema anti-torção

As bichas de chuveiro Giraflex da Ctesi são equipadas com sistema anti-torção, fazendo com que esta seja a escolha mais inteligente para quem pretende um duche agradável e pleno de conforto.

Graças ao seu revestimento, as bichas de chuveiro Giraflex apresentam-se com uma beleza ímpar, enquanto impedem que a torção interrompa o seu duche ou estrague a sua bicha de chuveiro.



rotação 360°

sistema anti-torção



### GIRAFLEX

REF.	MEDIDAS	COR			
CT2202150	1,50 m		1	25	
CT2202175	1,75 m	PRATA	1	25	
CT2202200	2,00 m		1	25	



### GIRAFLEX

REF.	MEDIDAS	COR			
CT2202177	1,75 m	PRETO	1	25	



### BICHA DE CHUVEIRO COM CONE

REF.	MEDIDAS	COR			
CT2211125	1,25 m		1	50	
CT2211150	1,50 m	CROMADO	1	50	
CT2211175	1,75 m		1	50	
CT2211200	2,00 m		1	50	



### BICHA DE CHUVEIRO EXTENSÍVEL COM CONE

REF.	MEDIDAS	COR			
CT2212500	1,25 » 2,20 m	CROMADO	1	50	



### BICHA DE CHUVEIRO DE COZINHA RETRÁTIL PARA BANCA

REF.	MEDIDAS	COR			
CT2214125	1,25 m	CROMADO	1	50	



# Bichas - malha de aço

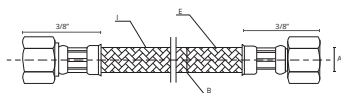

<b>I</b>	EPDM	<b>E</b>	AÇO INOX
<b>A</b>	DN INTERIOR 8mm	<b>B</b>	DN EXTERIOR 12mm
<b>PRESSÃO DE TRABALHO 10 BAR</b>			
<b>INTERVALO DE TEMPERATURA -10°C/90°C</b>			

## F/F 3/8" x 3/8"

REF.	MEDIDAS			
0700015	15 cm	10	200	
0700020	20 cm	10	100	
0700025	25 cm	10	100	
0700030	30 cm	10	100	
0700035	35 cm	10	100	
0700040	40 cm	10	100	
0700045	45 cm	10	100	
0700050	50 cm	10	100	

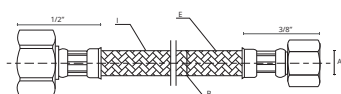

<b>I</b>	EPDM	<b>E</b>	AÇO INOX
<b>A</b>	DN INTERIOR 8mm	<b>B</b>	DN EXTERIOR 12mm
<b>PRESSÃO DE TRABALHO 10 BAR</b>			
<b>INTERVALO DE TEMPERATURA -10°C/90°C</b>			

## F/F 1/2" x 3/8"

REF.	MEDIDAS			
0702015	15 cm	10	200	
0702020	20 cm	10	100	
0702025	25 cm	10	100	
0702030	30 cm	10	100	
0702035	35 cm	10	100	
0702040	40 cm	10	100	
0702045	45 cm	10	100	
0702050	50 cm	10	100	

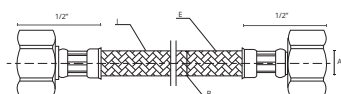

<b>I</b>	EPDM	<b>E</b>	AÇO INOX
<b>A</b>	DN INTERIOR 8mm	<b>B</b>	DN EXTERIOR 12mm
<b>PRESSÃO DE TRABALHO 10 BAR</b>			
<b>INTERVALO DE TEMPERATURA -10°C/90°C</b>			

## F/F 1/2" x 1/2"

REF.	MEDIDAS			
0704015	15 cm	10	200	
0704020	20 cm	10	100	
0704025	25 cm	10	100	
0704030	30 cm	10	100	
0704035	35 cm	10	100	
0704040	40 cm	10	100	
0704045	45 cm	10	100	
0704050	50 cm	10	100	
0704060	60 cm	10	100	
0704080	80 cm	10	100	
0704100	100 cm	10	50	

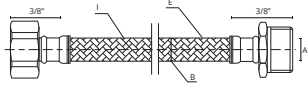

<b>I</b>	EPDM	<b>E</b>	AÇO INOX
<b>A</b>	DN INTERIOR 8mm	<b>B</b>	DN EXTERIOR 12mm
<b>PRESSÃO DE TRABALHO 10 BAR</b>			
<b>INTERVALO DE TEMPERATURA -10°C/90°C</b>			

**M/F**  
**3/8" x 3/8"**

REF.	MEDIDAS			
0701015	15 cm	10	200	
0701020	20 cm	10	100	
0701025	25 cm	10	100	
0701030	30 cm	10	100	
0701035	35 cm	10	100	
0701040	40 cm	10	100	
0701045	45 cm	10	100	
0701050	50 cm	10	100	

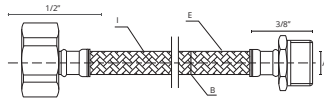

<b>I</b>	EPDM	<b>E</b>	AÇO INOX
<b>A</b>	DN INTERIOR 8mm	<b>B</b>	DN EXTERIOR 12mm
<b>PRESSÃO DE TRABALHO 10 BAR</b>			
<b>INTERVALO DE TEMPERATURA -10°C/90°C</b>			

**M/F**  
**1/2" x 3/8"**

REF.	MEDIDAS			
0703015	15 cm	10	200	
0703020	20 cm	10	100	
0703025	25 cm	10	100	
0703030	30 cm	10	100	
0703035	35 cm	10	100	
0703040	40 cm	10	100	
0703045	45 cm	10	100	
0703050	50 cm	10	100	

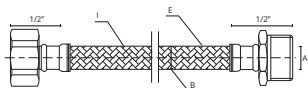

<b>I</b>	EPDM	<b>E</b>	AÇO INOX
<b>A</b>	DN INTERIOR 8mm	<b>B</b>	DN EXTERIOR 12mm
<b>PRESSÃO DE TRABALHO 10 BAR</b>			
<b>INTERVALO DE TEMPERATURA -10°C/90°C</b>			

**M/F**  
**1/2" x 1/2"**

REF.	MEDIDAS			
0705015	15 cm	10	200	
0705020	20 cm	10	100	
0705025	25 cm	10	100	
0705030	30 cm	10	100	
0705035	35 cm	10	100	
0705040	40 cm	10	100	
0705045	45 cm	10	100	
0705050	50 cm	10	100	

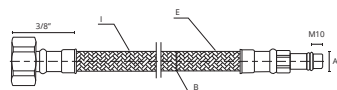

<b>I</b>	EPDM	<b>E</b>	AÇO INOX
<b>A</b>	DN INTERIOR 8mm	<b>B</b>	DN EXTERIOR 12mm
<b>PRESSÃO DE TRABALHO 10 BAR</b>			
<b>INTERVALO DE TEMPERATURA -10°C/90°C</b>			

**3/8" M10**  
PARA MONOCOMANDO

REF.	MEDIDAS			
0725030	30 cm	10	100	
0725035	35 cm	10	100	
0725040	40 cm	10	100	
0725050	50 cm	10	100	
0725060	60 cm	10	100	

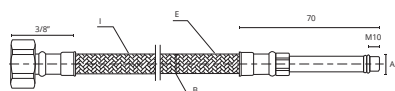

<b>I</b>	EPDM	<b>E</b>	AÇO INOX
<b>A</b>	DN INTERIOR 8mm	<b>B</b>	DN EXTERIOR 12mm
<b>PRESSÃO DE TRABALHO 10 BAR</b>			
<b>INTERVALO DE TEMPERATURA -10°C/90°C</b>			

**3/8" LONGA M10**  
PARA MONOCOMANDO

REF.	MEDIDAS			
0727035	30 cm	10	100	
0727050	35 cm	10	100	

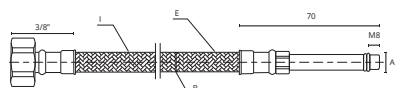

<b>I</b>	EPDM	<b>E</b>	AÇO INOX
<b>A</b>	DN INTERIOR 8mm	<b>B</b>	DN EXTERIOR 12mm
<b>PRESSÃO DE TRABALHO 10 BAR</b>			
<b>INTERVALO DE TEMPERATURA -10°C/90°C</b>			

**3/8" LONGA M8**  
PARA MONOCOMANDO

REF.	MEDIDAS			
0729035	35 cm	2	150	

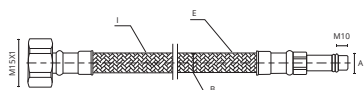
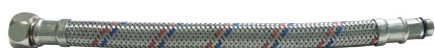

<b>I</b>	EPDM	<b>E</b>	AÇO INOX
<b>A</b>	DN INTERIOR 8mm	<b>B</b>	DN EXTERIOR 12mm
<b>PRESSÃO DE TRABALHO 10 BAR</b>			
<b>INTERVALO DE TEMPERATURA -10°C/90°C</b>			

PARA MONOCOMANDO COZINHA C/ CHUVEIRO

REF.	MEDIDAS			
0725025	20 cm	1	150	

# Perlatores economizadores

Os perlatores são componentes imprescindíveis para a poupança de água.

Previnem a acumulação dos pequenos detritos calcários e a limitação do caudal da água.

Com a nossa gama de Perlatores economizadores conseguirá uma redução de água até 50% nas torneiras da sua casa. Estes perlatores tem a função de misturar o ar com água, devido às suas aberturas laterais que permitem a entrada de ar, dando a mesma sensação de fluxo e pressão da água mas conseguindo uma redução bastante eficaz no seu caudal.



## LAVATÓRIO

REF.	MEDIDAS			
CT1950200	M24 x 1	10	250	

CONSUMO 6 L/MIN

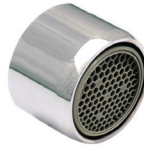

## BANCA

REF.	MEDIDAS			
CT1950205	F22 x 1	10	250	

CONSUMO 6 L/MIN



## KIT ECONOMIZADOR - INTERIOR PERLATOR

REF.	MEDIDAS			
CT1950230	-	10	250	

CONTÉM: 2 INTERIORES ECONOMIZADORES



## REDUTOR CHUVEIRO

REF.	MEDIDAS			
CT1950210	1/2"	10	200	

CONSUMO 8 L/MIN



## KIT ECONOMIZADOR - COMPLETO

REF.	MEDIDAS			
CT1950225	-	6	144	

CONTÉM: 2 PERLADORES ECONOMIZADORES PARA LAVATÓRIO; 1 PERLATOR ECONOMIZADOR PARA BANCA; 1 REDUTOR PARA CHUVEIRO



## KIT ECONOMIZADOR - SIMPLES

REF.	MEDIDAS			
CT1950235	-	6	168	

CONTÉM: 3 INTERIORES ECONOMIZADORES E 1 REDUTOR PARA CHUVEIRO

ARTIGOS FORNECIDOS EM BLISTER



## Para um planeta mais sustentável

Com as soluções Ctesi® Green fazemos com que pequenos gestos façam toda a diferença, poupando no consumo de água sem afetar a eficiência e o conforto no uso deste recurso essencial à vida no planeta.

# Perlatores



## LAVATÓRIO

REF.	MEDIDAS			
CT1950000	M24 x 1	10	1000	
CT1950001	M24 x 1 BLISTER	10	300	

CONSUMO 14 L/MIN



## LAVATÓRIO

REF.	MEDIDAS			
CT1950080	M18 x 1	10	-	
CT1950081	M18 x 1 BLISTER	5	-	
CT1950090	M20 x 1	10	-	
CT1950091	M20 x 1 BLISTER	5	-	

CONSUMO 14 L/MIN



## BANHEIRA

REF.	MEDIDAS			
CT1950010	M28 x 1	10	1000	
CT1950011	M28 x 1 BLISTER	10	-	

CONSUMO 14 L/MIN



## BANCA

REF.	MEDIDAS			
CT1950005	F22 x 1	10	-	
CT1950006	F22 x 1 BLISTER	10	300	

CONSUMO 14 L/MIN



## BIDÉ

REF.	MEDIDAS			
CT1950015	M22 x 1	10	1000	
CT1950016	M22 x 1 BLISTER	10	-	

CONSUMO 14 L/MIN



## PERLATOR

REF.	MEDIDAS			
CT1951250	F M16X1 HC	10	-	



## ADAPTADOR

REF.	MEDIDAS			
CT2216000	M24/M22	10	1000	

ARTIGO FORNECIDO EM BLISTER.



## BICA - RÓTULA CROMADO

REF.	MEDIDAS			
CT1950215	F22   M24	6	150	

CONSUMO 18 L/MIN. ARTIGO FORNECIDO EM BLISTER.



## BICA - FLEXÍVEL CROMADO

REF.	MEDIDAS			
CT1950220	F22   M24	6	50	

CONSUMO 12 L/MIN. ARTIGO FORNECIDO EM BLISTER.



**PERLATOR COIN**

REF.	MEDIDAS			
CT1952000	M24X1 HC A	10	-	



**PERLATOR CACHÉ**

REF.	MEDIDAS			
CT1952100	HC JR A	10	-	



**INTERIOR PERLATOR C/ ANILHAS**

REF.	MEDIDAS			
CT1950020	-	10	-	
CT1950021	BLISTER*	10	-	

\*CONTÉM: 2 INTERIORES PARA PERLADORES



**PERLATOR SLIM**

REF.	MEDIDAS			
CT1952200	M24X1	10	-	



**PERLATOR RECTANGULAR**

REF.	MEDIDAS			
CT1952500	RC 24x6mm	10	-	



**PERLATOR RECTANGULAR**

REF.	MEDIDAS			
CT1952550	RC 32x8 mm	10	-	



**CHAVE P/ PERLATOR CACHE**

REF.	MEDIDAS			
CT1959800	STD	10	-	



**CHAVE P/ PERLATOR CACHE**

REF.	MEDIDAS			
CT1959801	TT	10	-	



**CHAVE P/ PERLATOR SLIM**

REF.	MEDIDAS			
CT1959850	SSR	10	-	



# Bicas

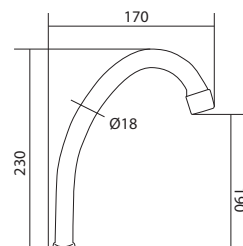

**BICA "J"**  
UNIVERSAL

REF.	MEDIDAS			
CT2218010	Ø18 x 220	1	100	

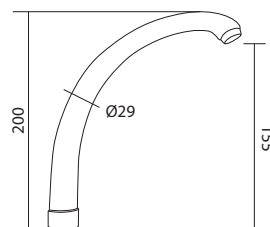

**BICA SUPERIOR**  
CROMADA

REF.	MEDIDAS			
CT2218050	28 x 200	1	100	

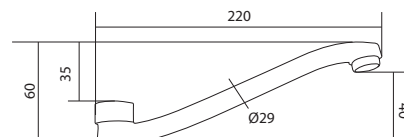

**BICA INFERIOR**  
CROMADA

REF.	MEDIDAS			
CT2218055	28 x 260	1	100	

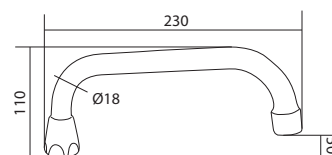

**BICA "U"**  
UNIVERSAL

REF.	MEDIDAS			
CT2218015	Ø18 x 220	1	100	

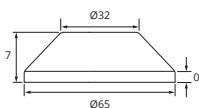

### ESPELHO NORMAL

LATÃO

REF.	MEDIDAS			
CT2120000	Ø65 mm	2	10	

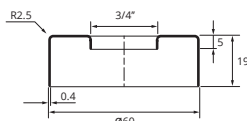
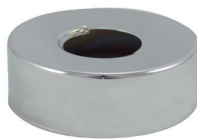

### ESPELHO CILÍNDRICO

LATÃO

REF.	MEDIDAS			
CT2120020	Ø60 mm	2	10	

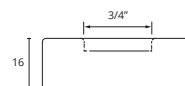

### ESPELHO QUADRADO

LATÃO

REF.	MEDIDAS			
CT2120030	70 x 70 mm	2	10	

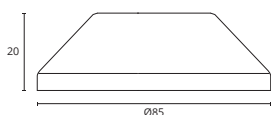
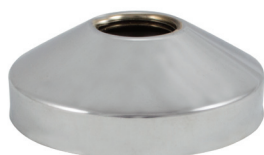

### ESPELHO ESPECIAL

LATÃO

REF.	MEDIDAS			
CT2120011	Ø85 mm	2	10	

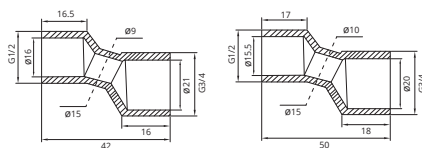

### EXCÊNTRICO P/ MISTURADORA

NORMAL

REF.	MEDIDAS			
CT2120200	H42 mm*	2	10	
CT2120201	H50 mm*	2	10	

EXCENRICIDADE 9 mm // \*1/2" X 3/4"

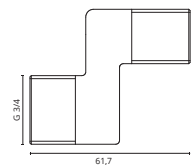

### EXCÊNTRICO P/ MISTURADORA

ESPECIAL

REF.	MEDIDAS			
CT2120210	1/2" x 3/4"	2	10	



### KIT EXCÊNTRICO H42

C/ ESPELHO NORMAL

REF.	MEDIDAS			
CT2120250	LATÃO - CROMADO	2	300	



### KIT EXCÊNTRICO H50

C/ ESPELHO CILÍNDRICO

REF.	MEDIDAS			
CT2120260	LATÃO - CROMADO	2	200	



### KIT EXCÊNTRICO H50

C/ ESPELHO QUADRADO

REF.	MEDIDAS			
CT2120270	LATÃO - CROMADO	2	200	

# Ferragens



## FERRAGENS 2 PARAFUSOS

REF.	MEDIDAS			
CT2121810	M6 x 55 mm	1	150	



## FERRAGENS 1 PARAFUSO PEQUENO

REF.	MEDIDAS			
CT2121800	M8 x 55 mm	1	150	



## FERRAGENS 1 PARAFUSO MÉDIO

REF.	MEDIDAS			
CT2121820	M8 x 120 mm	1	100	



## FERRAGENS 1 PARAFUSO GRANDE

REF.	MEDIDAS			
CT2121830	M8 x 270 mm	1	100	



## EMBELEZADOR P/ CARTUCHO

REF.	MEDIDAS			
CT9020222	35 mm - Ø40 x 1,25	1	-	
CT9020227	40 mm - Ø45 x 1,25	1	-	



## PORCA APERTO P/ CARTUCHO

REF.	MEDIDAS			
CT9020202	35 mm - M37 x 1,25	1	-	
CT9020207	40 mm - M42 x 1,25	1	-	

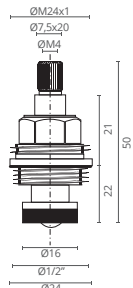

## CASTELO ESTRIADO CURTO

REF.	MEDIDAS			
CT2121000	1/2" - 8 mm	10	200	

AMPLITUDE DE VEDAÇÃO ATÉ 22 mm

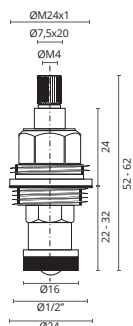

## CASTELO ESTRIADO ESPECIAL

REF.	MEDIDAS			
CT2121020	1/2" - 8 mm	10	200	

AMPLITUDE DE VEDAÇÃO ATÉ 32 mm

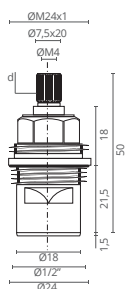

## CASTELO ESTRIADO CERÂMICO 1/4" VOLTA

REF.	MEDIDAS			
CT2121200	8 mm x 20 FRIO	10	200	
CT2121201	8 mm x 20 QUENTE	10	200	

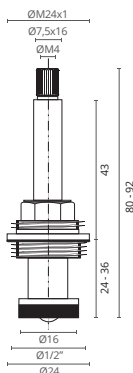

## CASTELO ESTRIADO PASSADOR

REF.	MEDIDAS			
CT2121100	1/2" - 8 mm	10	200	
CT2121110	3/4" - 8 mm	10	100	

# Cartuchos

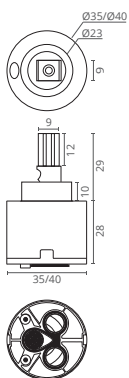

- Ângulo máximo abertura: 25°
- Temperatura máxima: 90°C
- Pressão máxima: 35 Bar
- Vida esperada: 70.000 ciclos EN817

### CARTUCHO UNIVERSAL

REF.	MEDIDAS			
CT2121410	Ø35 mm	5	80	
CT2121420	Ø40 mm	5	80	

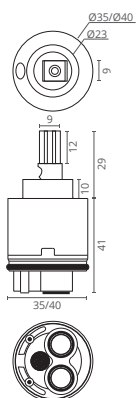

- Ângulo máximo abertura: 25°
- Temperatura máxima: 90°C
- Pressão máxima: 35 Bar
- Vida esperada: 70.000 ciclos EN817

### CARTUCHO UNIVERSAL C/ DISTRIBUIDOR

REF.	MEDIDAS			
CT2121411	Ø35 mm	5	80	
CT2121421	Ø40 mm	5	80	

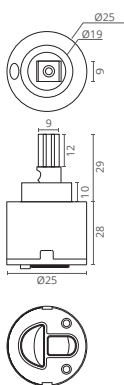

- Ângulo máximo abertura: 25°
- Temperatura máxima: 90°C
- Pressão máxima: 35 Bar
- Vida esperada: 70.000 ciclos EN817

### CARTUCHO Ø25 - 1 ÁGUA

REF.	MEDIDAS			
CT2121405	Ø25 mm	5	-	

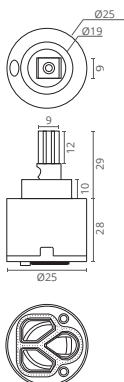

### CARTUCHO Ø25

REF.	MEDIDAS			
CT2121400	Ø25 mm	5	-	

# Sistemas Multicamada

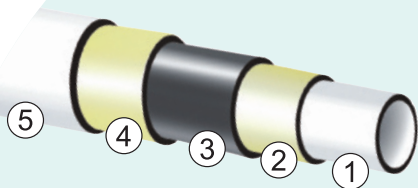

- 1ª Camada (interior): Tubo PEX-B. Polietileno Reticulado resistente a altas temperaturas, de acordo com a UNE-EN ISO 21003
- 2ª Camada: Adesivo especial para colar plástico e metal, com ponto de fusão superior a 120°C
- 3ª Camada (central): Folha de alumínio soldada longitudinalmente por processo de ultra-sons
- 4ª Camada: Adesivo especial para colar plástico e metal, com ponto de fusão superior a 120°C
- 5ª Camada (exterior): Tubo PE. Polietileno resistente a altas temperaturas, de acordo com a UNE-EN ISO 21003

A tecnologia de fabricação dos tubos multicamada garante perfeita soldagem do alumínio, além de boa aderência entre plástico e metal, obtendo assim uma alta qualidade dos tubos, que atende perfeitamente aos requisitos do mercado.



UNE-EN ISO 21003  
001/007094

## Tubo PEX / AL / PE

REF.	MEDIDAS		
4020000	ROLO TUBO PEX/AL/PE 16 x 2.0 mm	100 m	2600 m
4020002	ROLO TUBO PEX/AL/PE 20 x 2.0 mm	100 m	1500 m
4020003	ROLO TUBO PEX/AL/PE 25 x 2.5 mm	50 m	700 m
4020004	ROLO TUBO PEX/AL/PE 32 x 3.0 mm	50 m	550 m

## Acessórios multicamada

Os acessórios multicamada da Ctesi encontram-se em conformidade com as normativas europeias, excluindo o níquel como elemento do composto.

Todas as partes que estão em contacto com a água são compostos em latão não contendo níquel.

Deste modo garante-se o cumprimento da adequação a uso alimentar, mantendo sempre a garantia de qualidade da Ctesi.

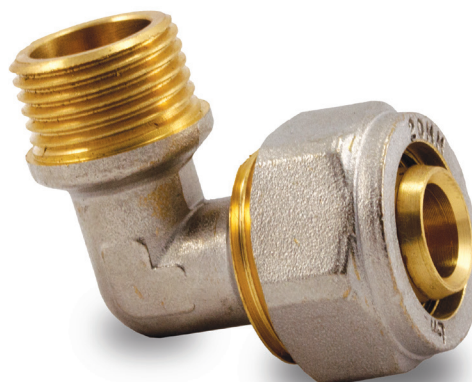



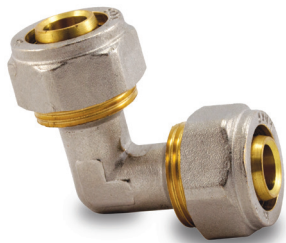

	B	C	D
4023000	16	33	33
4023001	20	35	35
4023002	25	42	42

medidas em mm

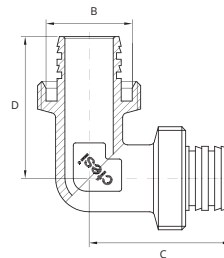

JOELHOS SIMPLES

REF.	MEDIDAS			
4023000	16	16	96	
4023001	20	12	72	
4023002	25	8	48	



	B	E	C	D
4023050	16	20	36	42
4023051	20	25	38	43

medidas em mm

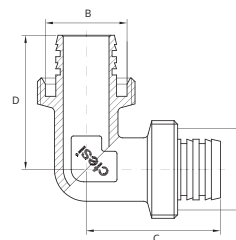

JOELHOS REDUÇÃO

REF.	MEDIDAS			
4023050	16 x 20	12	72	
4023051	20 x 25	8	48	



	A	B	C	D
4023100	1/2"	16	36	33
4023101	1/2"	20	36	32
4023102	3/4"	20	38	34
4023103	3/4"	25	42	39

medidas em mm

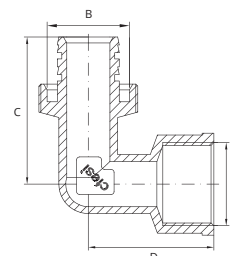

JOELHOS ROSCA FÊMEA

REF.	MEDIDAS			
4023100	16 x 1/2"	12	96	
4023101	20 x 1/2"	13	78	
4023102	20 x 3/4"	12	72	
4023103	25 x 3/4"	8	48	

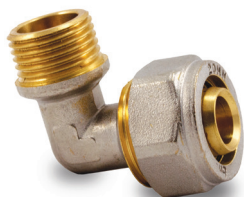

	A	B	C	D
4023150	1/2"	16	32	32
4023151	1/2"	20	36	31
4023152	3/4"	20	38	33
4023153	3/4"	25	42	36

medidas em mm

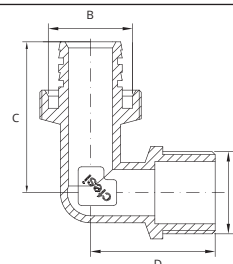

JOELHOS ROSCA MACHO

REF.	MEDIDAS			
4023150	16 x 1/2"	20	120	
4023151	20 x 1/2"	15	90	
4023152	20 x 3/4"	12	72	
4023153	25 x 3/4"	8	48	



	A	B	C	D
4023200	1/2"	16	35	42
4023203	3/4"	16	40	46
4023201	1/2"	20	37	43
4023202	3/4"	20	40	46

medidas em mm

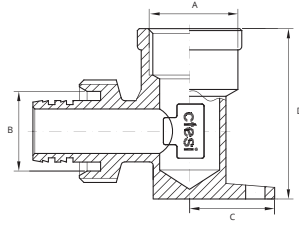

#### JOELHOS PATER

REF.	MEDIDAS			
4023200	16 x 1/2"	14	84	
4023203	16 x 3/4"	12	72	
4023201	20 x 1/2"	12	72	
4023202	20 x 3/4"	10	60	

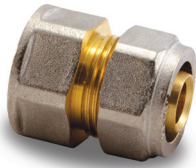

	A	B	C
4023550	1/2"	16	36.5
4023551	1/2"	20	34.5
4023554	3/4"	16	37.5
4023555	3/4"	20	34.5
4023556	3/4"	25	37

medidas em mm

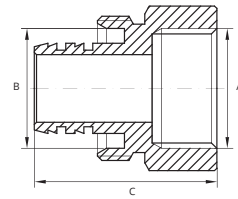

#### CASQUILHOS FÊMEA

REF.	MEDIDAS			
4023550	16 x 1/2"	25	150	
4023551	20 x 1/2"	20	120	
4023554	16 x 3/4"	20	120	
4023555	20 x 3/4"	18	108	
4023556	25 x 3/4"	10	60	

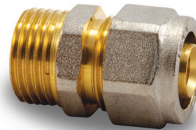

	A	B	C
4023600	1/2"	16	38
4023601	1/2"	20	40.5
4023604	3/4"	16	39.5
4023606	3/4"	25	44.5

medidas em mm

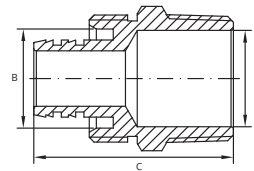

#### CASQUILHOS MACHO

REF.	MEDIDAS			
4023600	16 x 1/2"	30	180	
4023601	20 x 1/2"	20	120	
4023604	16 x 3/4"	15	150	
4023606	25 x 3/4"	10	60	



	B	C
4023450	16	46
4023451	20	50
4023452	25	50

medidas em mm

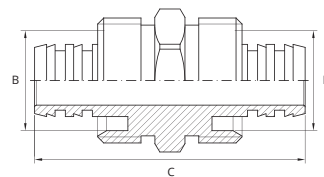

#### UNIÕES SIMPLES

REF.	MEDIDAS			
4023450	16	25	150	
4023451	20	12	72	
4023452	25	7	42	

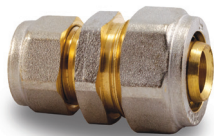

	B	E	C
4023500	16	20	45
4023501	20	25	49.5

medidas em mm

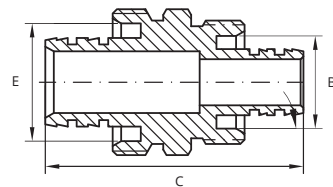

**UNIÕES REDUÇÃO**

REF.	MEDIDAS			
4023500	16 x 20	16	96	
4023501	25 x 20	7	42	

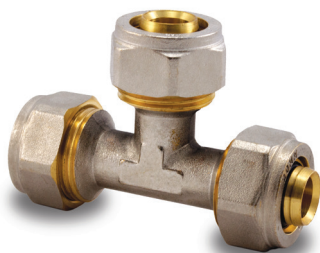

	B	C	D
4023250	16	67	33.5
4023251	20	72	36
4023252	25	82	39

medidas em mm

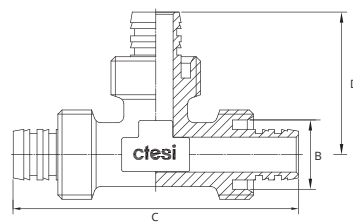

**TÊS SIMPLES**

REF.	MEDIDAS			
4023250	16	12	72	
4023251	20	8	48	
4023252	25	4	24	



	E	F	G	C	D
4023301	20	16	20	67	32
4023304	25	20	25	70	39

medidas em mm

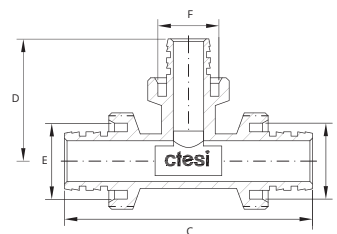

**TÊS REDUÇÃO**

REF.	MEDIDAS			
4023301	20 x 16 x 20	10	60	
4023304	25 x 20 x 25	4	24	

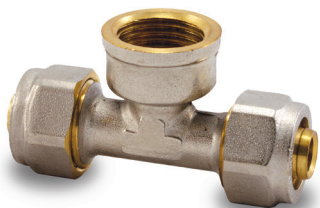

	A	B	C	D
4023350	1/2"	16	70	30
4023351	1/2"	20	76	32
4023352	3/4"	20	76	32
4023353	3/4"	25	82	39

medidas em mm

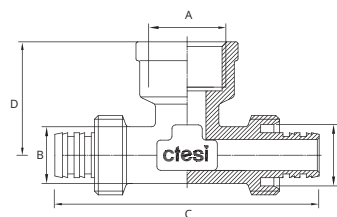

**TÊS ROSCA FÊMEA**

REF.	MEDIDAS			
4023350	16 x 1/2" x 16	12	72	
4023351	20 x 1/2" x 20	8	48	
4023352	20 x 3/4" x 20	8	48	
4023353	25 x 3/4" x 25	5	30	



	A	B	C	D
4021000	38.5	38.5	Ø16	Ø16
4021002	40	40	Ø20	Ø20
4021003	48.5	48.5	Ø25	Ø25
4021004	54	54	Ø32	Ø32

medidas em mm

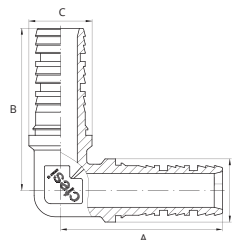

#### JOELHOS SIMPLES

REF.	MEDIDAS			
4021000	16	20	120	
4021002	20	16	96	
4021003	25	8	48	
4021004	32	5	30	



	A	B	C	D
4021020	40	27	G1/2"	Ø16
4021021	42	29	G3/4"	Ø16
4021022	40	27	G1/2"	Ø20
4021023	44	30	G3/4"	Ø20
4021024	49.5	32	G1/2"	Ø25
4021025	50.5	32	G3/4"	Ø25
4021026	56.5	38	G1	Ø32

medidas em mm

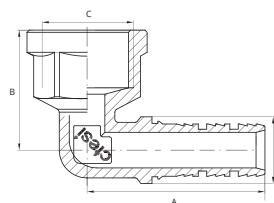

#### JOELHOS ROSCA FÊMEA

REF.	MEDIDAS			
4021020	16 x 1/2"	20	120	
4021021	16 x 3/4"	16	96	
4021022	20 x 1/2"	16	96	
4021023	20 x 3/4"	12	72	
4021024	25 x 1/2"	12	72	
4021025	25 x 3/4"	12	72	
4021026	32 x 1"	5	30	



	A	B	C	D
4021040	38.5	25	G1/2"	Ø16
4021041	41.5	28	G3/4"	Ø16
4021042	38.5	27	G1/2"	Ø20
4021043	41	29	G3/4"	Ø20
4021044	48.5	31.5	G3/4"	Ø25

medidas em mm

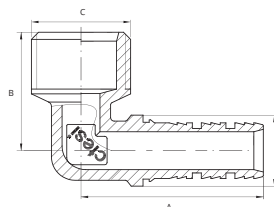

#### JOELHOS ROSCA MACHO

REF.	MEDIDAS			
4021040	16 x 1/2"	20	120	
4021041	16 x 3/4"	15	90	
4021042	20 x 1/2"	20	120	
4021043	20 x 3/4"	15	90	
4021044	25 x 3/4"	10	60	



	A	B	C	D
4021060	41.4	Ø16	G1/2"	39
4021061	41.4	Ø20	G1/2"	39
4021062	44	Ø16	G3/4"	41
4021063	44.5	Ø20	G3/4"	39

medidas em mm

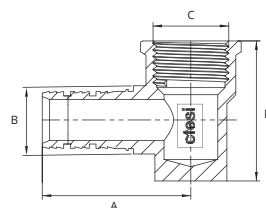

#### JOELHOS PATER

REF.	MEDIDAS			
4021060	16 x 1/2"	12	72	
4021061	20 x 1/2"	8	48	
4021062	16 x 3/4"	8	48	
4021063	20 x 3/4"	6	42	



	A	B	C	D	E	F
4021100	71	35.5	Ø16	35.5	Ø16	Ø16
4021102	75	37.5	Ø20	37.5	Ø20	Ø20
4021103	92	46	Ø25	46	Ø25	Ø25
4021104	102	51	Ø32	51	Ø32	Ø32

medidas em mm

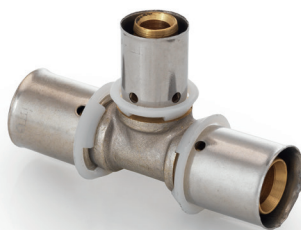

	A	B	C	D	E	F
4021130	Ø20	71	35.5	Ø16	37.5	Ø16
4021131	Ø20	71	35.5	Ø20	37.5	Ø16
4021133	Ø20	75	37.5	Ø16	37.5	Ø20
4021140	Ø25	84	42	Ø25	39.5	Ø16
4021142	Ø25	81.5	37.5	Ø20	39.5	Ø20
4021143	Ø25	88	44	Ø25	39.5	Ø20
4021144	Ø25	87	39.5	Ø20	47.5	Ø25
4021153	Ø32	96	48	Ø32	49	Ø25

medidas em mm



	A	B	C	D
4021180	83	27	G1/2"	Ø16
4021181	83	29	G1/2"	Ø20
4021182	102	32	G3/4"	Ø25

medidas em mm



	A	B	C	D
4021200	52	25	Ø16	Ø16
4021202	52	25	Ø20	Ø20
4021202	65	31	Ø25	Ø25
4021204	69	33	Ø32	Ø32

medidas em mm

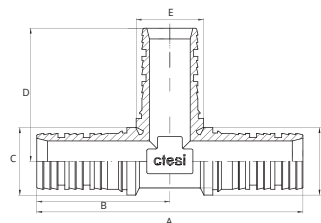

TÊS SIMPLES

REF.	MEDIDAS			
4021100	16	16	96	
4021102	20	12	72	
4021103	25	5	30	
4021104	32	3	18	

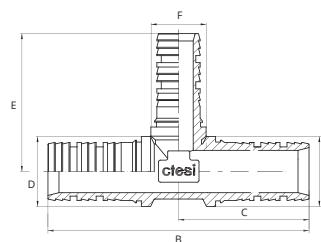

TÊS SIMPLES

REF.	MEDIDAS			
4021130	20 x 16 x 16	12	72	
4021131	20 x 16 x 20	12	72	
4021133	20 x 20 x 16	12	72	
4021140	25 x 16 x 25	6	30	
4021142	25 x 20 x 20	6	30	
4021143	25 x 20 x 25	6	30	
4021144	25 x 25 x 20	6	30	
4021153	32 x 25 x 32	3	18	

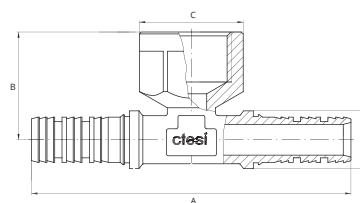

TÊS ROSCA FÊMEA

REF.	MEDIDAS			
4021180	16 x 1/2" x 16	12	72	
4021181	20 x 1/2" x 20	12	72	
4021182	25 x 3/4" x 25	5	30	

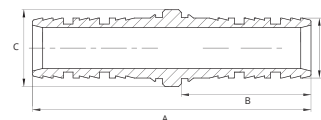

UNIÕES SIMPLES

REF.	MEDIDAS			
4021200	16	24	144	
4021202	20	20	120	
4021203	25	12	72	
4021204	32	8	48	



	A	B	C	D
4021220	52	25	Ø20	Ø16
4021223	58	25	Ø20	Ø25
4021225	67	31	Ø25	Ø32

medidas em mm

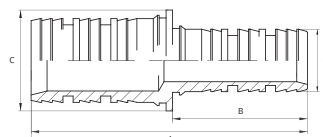

#### UNIÕES REDUÇÃO

REF.	MEDIDAS			
4021220	20 x 16	20	120	
4021223	25 x 20	12	72	
4021225	32 x 25	8	48	



	A	B	C	D
4021300	41	25.4	G1/2"	Ø16
4021301	43	25.4	G3/4"	Ø16
4021302	41.4	25.4	G1/2"	Ø20
4021303	43.4	25.4	G3/4"	Ø20
4021304	50	31.9	G1/2"	Ø25
4021305	50	31.9	G3/4"	Ø25
4021306	52	33.9	G1"	Ø32

medidas em mm

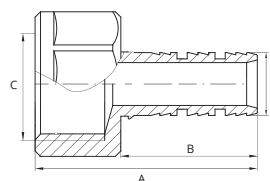

#### CASQUILHOS FÊMEA

REF.	MEDIDAS			
4021300	16 x 1/2"	24	144	
4021301	16 x 3/4"	16	96	
4021302	20 x 1/2"	20	120	
4021303	20 x 3/4"	16	96	
4021304	25 x 1/2"	8	48	
4021305	25 x 3/4"	12	72	
4021306	32 x 1"	8	48	



	A	B	C	D
4021320	45	25	G1/2"	Ø16
4021321	45	25	G3/4"	Ø16
4021323	45.5	25	G1/2"	Ø20
4021324	46.5	25	G3/4"	Ø20
4021326	53	31	G3/4"	Ø25
4021328	58.5	33	G1"	Ø32

medidas em mm

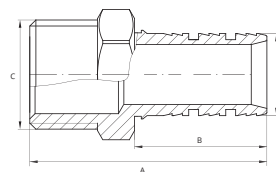

#### CASQUILHOS MACHO

REF.	MEDIDAS			
4021320	16 x 1/2"	24	144	
4021321	16 x 3/4"	20	120	
4021323	20 x 1/2"	24	144	
4021324	20 x 3/4"	16	96	
4021326	25 x 3/4"	12	72	
4021328	32 x 1"	8	48	

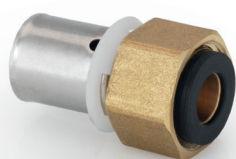

	A	B	C	D	E
4021340	14.5	G1/2"	41.5	25	Ø16
4021342	14.5	G1/2"	43	25	Ø20
4021343	16	G3/4"	43	25	Ø20
4021344	16	G3/4"	49	31	Ø25

medidas em mm

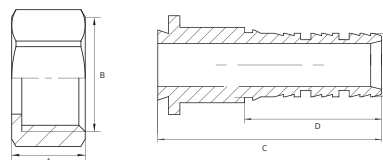

#### CASQUILHOS FÊMEA C/ PORCA

REF.	MEDIDAS			
4021340	16 x 1/2"	24	144	
4021342	20 x 1/2"	20	120	
4021343	20 x 3/4"	16	96	
4021344	25 x 3/4"	12	72	



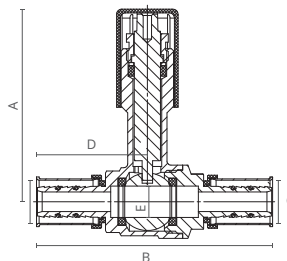

	A	B	C	D	E
4021550	72.5	90.5	Ø16	42.5	Ø12
4021551	72.5	90.5	Ø20	42.5	Ø12
4021552	76.1	105	Ø25	49.5	Ø15

medidas em mm

VÁLVULAS ESFERA S/ MANÍPULO

REF.	MEDIDAS			
4021550	16	6	24	
4021551	20	6	24	
4021552	25	6	24	

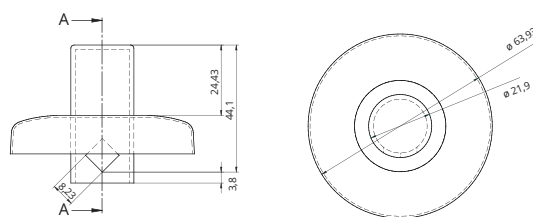

MANÍPULO

REF.	MEDIDAS			
4021562	ROSCA OCULTA	5	50	

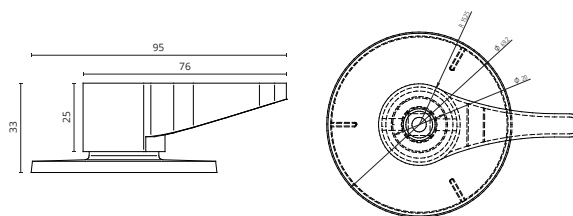

MANÍPULO ALAVANCA

REF.	MEDIDAS			
4021561	ALAVANCA			

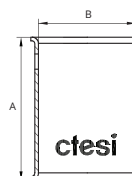

ANILHAS COMPRESSÃO

	A	B
4021460	23.5	Ø16
4021461	23.5	Ø20
4021462	31	Ø25
4021463	31	Ø32

medidas em mm

REF.	MEDIDAS			
4021460	16	10	100	
4021461	20	10	100	
4021462	25	10	100	
4021463	32	10	100	

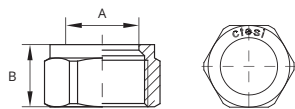

**PORCA**

REF.	MEDIDAS			
4023700	16 x 14	10	100	
4023701	20 x 15	10	100	
4023702	25 x 15	10	100	

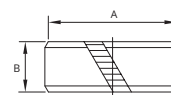

**ANILHA**

REF.	MEDIDAS			
4023750	16 x 8	10	100	
4023751	20 x 8	10	100	
4023752	25 x 8.5	10	100	



**CALIBRADOR**

REF.	MEDIDAS			
4021910	Ø16 x 18 x 20	1	100	
4021911	Ø20 x 25 x 32	1	100	



**ABRAÇADEIRA CLIP**

REF.	MEDIDAS			
4023911	20	100	700	
4023912	25	100	400	
4023913	32	50	200	



**TESOURA**

REF.	MEDIDAS			
4021980	16 - 32	1	20	

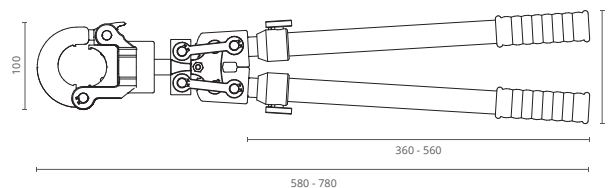

<b>AMPLITUDE DE CRAVAMENTO</b>	DIAM. 16 - 32 (mm)
<b>FORÇA</b>	1,1T
<b>COMPRIMENTO (MIN-MÁX)</b>	560 - 770 mm
<b>MATRIZES</b>	16; 20; 25; 32 (mm)

**ALICATE CABEÇA ROTATIVA**

REF.	MEDIDAS			
4021905	16 - 32	1	-	

FORNECIDO COM MALA. INCLUI MATRIZES 16, 20, 25 E 32.

# Acessórios cromados



## CURTOS CASQUILHOS

REF.	MEDIDAS			
1002001	3/8" x 1 cm	10	300	
1002002	1/2" x 1 cm	10	300	
1002003	3/4" x 1 cm	10	300	



## 1/2" x 3/8" CASQUILHOS

REF.	MEDIDAS			
1002010	2 cm	10	300	
1002011	3 cm	10	300	
1002012	4 cm	10	300	



## 1/2" x 1/2" CASQUILHOS

REF.	MEDIDAS			
1002020	2 cm	10	300	
1002021	3 cm	10	300	
1002022	4 cm	10	300	



## 3/4" x 3/4" CASQUILHOS

REF.	MEDIDAS			
1002040	2 cm	10	-	



## 3/4" x 1/2" CASQUILHOS

REF.	MEDIDAS			
1002030	1 cm	10	-	
1002031	2 cm	10	-	

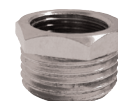

## PORCAS REDUÇÃO

REF.	MEDIDAS			
1020301	1/2" x 3/8"	10	700	
1020302	3/4" x 1/2"	10	-	



## 1/2" x 1/2" - Ø27 AUMENTOS

REF.	MEDIDAS			
1000401	1 cm	10	250	
1000402	1,5 cm	10	200	
1000403	2 cm	10	200	
1000405	3 cm	10	150	
1000407	5 cm	5	100	
1000408	8 cm	5	60	



## F/F UNIÕES

REF.	MEDIDAS			
1030100	1/2"	10	-	



## M/F UNIÃO REDUÇÃO

REF.	MEDIDAS			
1030001	1/2" x 3/8"	10	400	
1030002	3/4" x 1/2"	10	300	

# Acessórios cromados

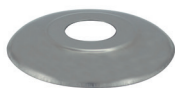

## ESPELHO SIMPLES

REF.	MEDIDAS			
1014003	1/2" - 55 mm	25	600	
1014005	1/2" - 75 mm	25	400	



## ESPELHO CROMADO C/ TACHO MACHO

REF.	MEDIDAS			
1014070	1/2"	25	250	



## TACOS MACHO

REF.	MEDIDAS			
1972000	3/8"	10	-	
1972001	1/2"	10	-	



## TAMPÕES FÊMEA

REF.	MEDIDAS			
1972004	3/8"	10	-	
1972005	1/2"	10	-	



## HASTES P/ CHUVEIRO

REF.	MEDIDAS			
1062002	35 cm	5	100	
1062003	40 cm	5	100	
1062005	50 cm	5	100	



## TAPA FUROS

REF.	MEDIDAS			
1972060	CROMADO	10	250	
1972061	BRANCO	10	250	



## PINHA RÓTULA

REF.	MEDIDAS			
1060005	CROMADO	5	100	



## PINHA SIMPLES

REF.	MEDIDAS			
1060001	CROMADO	5	100	

# Kit parafusos



## KIT P/ LAVATÓRIO

REF.	ACABAMENTO			
0182001	CROMADO	10	200	



## KIT P/ SANITA / BIDÉ

REF.	ACABAMENTO			
0182002	CROMADO	10	200	



## KIT P/ SANITA / BIDÉ

REF.	ACABAMENTO			
0182003	AÇO INOX	10	250	



## KIT P/ SANITA ROCA

REF.	ACABAMENTO			
0182005	CROMADO	10	250	

# Condições gerais de venda

A Barros & Moreira, S.A. e os seus clientes aceitam as seguintes condições gerais de venda a partir do momento em que a encomenda é formalizada:

## 1 CATÁLOGO E ENCOMENDAS

- 1.1 Os preços aqui apresentados são meramente orientativos, reservando-se a Barros & Moreira a alterações dos mesmos sem aviso prévio. A estes preços acresce IVA, à taxa legal em vigor.
- 1.2 As informações existentes em catálogo são apresentadas apenas a título informativo, sendo possível efetuar alterações sem que exista um aviso prévio por parte da Barros & Moreira.
- 1.3 A confirmação de encomenda e prazo de entrega são sempre em função das disponibilidades de stock. Não é passível de qualquer indemnização a cliente, devido a atraso na entrega de encomendas.
- 1.4 Não é possível anulação, de encomendas que contenham produtos denominados especiais, em que, já se tenha iniciado o processo de fabricação.
- 1.5 A mercadoria permanece propriedade da Barros & Moreira, S.A., até à total liquidação da mesma.
- 1.6 Os produtos consideram-se entregues, após a sua descarga e confirmação por parte do cliente, através da sua assinatura no documento que se faz acompanhar. Caso a mercadoria seja entregue por transportadora é necessário, assinalar no talão de carga, todas as evidências físicas de como a mesma foi entregue, para que mais tarde, seja passível de reclamação. Não será considerada qualquer reclamação de "produto danificado por transporte" que não contenha anotação prévia no título de descarga.

## 2 GARANTIA

- 2.1 Os produtos apresentados neste catálogo têm uma garantia de 3 anos, a partir da data da compra, salvo exceções indicadas e produto específico.

Como por exemplo:

Torneiras : 5 anos (à exceção dos modelos termostáticos e eletrónicos e complementos de torneiras – chuveiros, rampas e colunas de duche, bichas flexíveis, etc., que têm 3 anos)

Autoclismos Interiores: 10 anos (excluem-se desta garantia as peças de desgaste rápido).

- 2.2 As garantias incluem a total ou parcial substituição do produto, em caso de avaria, desde que, esta seja devido a defeito de fabrico. As garantias não cobrem situações decorrentes de utilização negligente, instalação incorreta, manutenção deficiente ou de motivos de causa maior.
- 2.3 O produto defeituoso deverá ser entregue com o certificado que o acompanha, devidamente preenchido, caso contrário considera-se excluída a possibilidade de reparação e/ou reposição do mesmo.
- 2.4 As reclamações devem ser endereçadas à Barros & Moreira por escrito, até a um prazo máximo, de 10 dias, a contar do dia de carga do produto.
- 2.5 Todas as reclamações carecem de análise e aprovação por parte do nosso departamento técnico. No caso de ser emitido um parecer positivo, a Barros & Moreira, será responsável pela reparação do artigo e só em último caso pela reposição de um novo ou do valor pago pelo mesmo.
- 2.6 São possíveis as devoluções de produto, desde que, até 10 dias após a compra e processo previamente aceite pela Barros & Moreira. Não são aceites devoluções de produtos especiais, assim como, produtos já aplicados e/ ou danificados. Poderão ser imputados ao cliente custos, processuais, de embalagem e logísticos.

## 3 JURISDIÇÃO

Em caso de Litígio, o foro competente é o da comarca das Caldas da Rainha.

## 4 ADVERTÊNCIAS

Reservamo-nos ao direito de proceder a qualquer alteração, sem qualquer aviso prévio, nos preços, materiais e especificações descritas.

As medidas apresentadas são a título orientativo, assim como, as cores apresentadas neste catálogo poderão variar da realidade, devido a variações de impressão.





**ctesi**

É UMA CASA DE BANHO PORTUGUESA, COM CERTEZA!

# ctesi

[www.ctesi.pt](http://www.ctesi.pt)

CT,CAT,NPT,02

**Barros & Moreira, SA**

Rua Industrial, nº 8  
Zon Industrial da Ponte Seca  
2510-752 Gaeiras - Óbidos  
Portugal

[geral@barros-moreira.pt](mailto:geral@barros-moreira.pt)  
[www.ctesi.pt](http://www.ctesi.pt)  
Tel.: (+351) 262 837 230 || Fax: (+351) 262 837 231  
Serviço de apoio pós venda **LINHA AZUL 808 203 870**